



HAY NEW ORDER PRICELIST

KAMMARKOLLEGEIET AVROPA
2024 JANUARI. PRISER EXKL MOMS

SWEDEN JANUARY 2024

REC. RETAIL PRICES IN SEK EXCL. VAT

Subject to increases in prices and printing errors

CONTENT

NEW ORDER OVERVIEW	4	TABLE INCL. PLUG & PLAY CABLE MANAGEMENT EDGE 4 LEGS.....	38
SHELF.....	17	TABLE INCL. CABLE MANAGEMENT EDGE 34 CM 4 LEGS.....	38
TRAY	17	TABLE INCL. PLUG & PLAY CABLE MANAGEMENT EDGE 34 CM 4 LEGS ..	39
PROFILE	18	TABLE INCL. CABLE MANAGEMENT EDGE 34 CM PREPARED FOR TOP TRAY DIVIDER 4 LEGS.....	39
BENCHTOP	19	TABLE INCL. PLUG & PLAY CABLE MANAGEMENT EDGE 34 CM PREPARED FOR TOP TRAY DIVIDER 4 LEGS.....	40
STEEL PANEL	22	TABLE INCL. CABLE MANAGEMENT PREPARED FOR TOP TRAY DIVIDER AND TABLE SCREENS EDGE 4 LEGS.....	40
STEEL SHELF FOR ADJUSTABLE SIDE PANELS	23	TABLE INCL. PLUG & PLAY CABLE MANAGEMENT PREPARED FOR TOP TRAY DIVIDER AND TABLE SCREENS EDGE 4 LEGS.....	41
PINS FOR ADJUSTABLE SHELF SET OF 4	23	TABLE INCL. CABLE MANAGEMENT CENTER OR PREPARED FOR TABLE SCREENS 4 LEGS	41
STEEL PANEL WALL	24	TABLE INCL. CABLE MANAGEMENT CENTER OR PREPARED FOR TABLE SCREENS 4 LEGS	42
STEEL PANEL TABLE	24	TABLE INCL. PLUG & PLAY CABLE MANAGEMENT CENTER OR PREPARED FOR TABLE SCREENS 4 LEGS.....	42
FITTINGS	25	TABLE INCL. PLUG & PLAY CABLE MANAGEMENT CENTER OR PREPARED FOR TABLE SCREENS 4 LEGS.....	43
TEXTILE PANEL	26	TABLE INCL. DOUBLE PLUG & PLAY CABLE MANAGEMENT CENTER IN COMBINATION WITH TABLE SCREENS 4 LEGS.....	43
INSIDE TEXTILE PANEL	27	TABLE SCREEN.....	44
STEEL SLIDING DOOR.....	28	TABLE SCREEN.....	44
STEEL SLIDING DOOR PREPARED F/ LOCK	29	TABLE LEG SINGLE	45
HIGH DRAWER	30	TABLE LEG DOUBLE	45
DRAWER.....	30	TABLE CONNECTOR	46
STEEL MIDDLE BAR FOR DRAWER	31	CABLE CLIP SET OF 2.....	46
STEEL LOCK BAR FOR DRAWER.....	31	CABLE GUIDE	46
LOCK CYLINDER.....	31	HIGH TABLE H90 CM.....	47
EXTRA KEY FOR LOCK CYLINDER.....	31	HIGH TABLE H105 CM.....	47
MASTER KEY	32	CABLE TRAY FOR L35	48
EXCHANGE KEY FOR LOCK CYLINDER	32	CABLE TRAY FOR STEP L35	48
FITTINGS WALL BRACKET	33	STEP MODULES FOR CABLE MANAGEMENT	49
FITTINGS SAFETY BRACKET SET OF 2.....	33	STEP MODULES FOR CABLE MANAGEMENT	50
FITTINGS SAFETY BRACKET SET OF 2.....	33	STEP MODULE EXTENSION CABLE.....	51
REPAIR KIT.....	34	STEP MODULES SUPPLY CABLES.....	51
WHEELS SET OF 4	34	CABLE COVER W/ PEN HOLDER.....	52
BOOK DIVIDER	34	CABLE COVER	52
TROLLEY A 1 DRAWER W/ LOCK.....	35	COMBINATION 101	53
TROLLEY B 3 DRAWER W/ LOCK.....	35	COMBINATION 102.....	53
TABLE 4 LEGS.....	36	COMBINATION 103.....	53
TABLE 4 LEGS.....	36		
TABLE INCL. SINGLE PLUG & PLAY 4 LEGS.....	37		
TABLE INCL. CABLE MANAGEMENT EDGE 4 LEGS	37		

BENCH COMBINATION L100	54
BENCH COMBINATION L150.....	54
COMBINATION 201.....	54
COMBINATION 202	55
COMBINATION 203	55
COMBINATION 204	55
COMBINATION 205	56
COMBINATION 301.....	56
COMBINATION 303	57
COMBINATION 401.....	57
COMBINATION 501.....	58
COMBINATION 502	58
COMBINATION 701.....	59
COMBINATION 702	59
TABLE COMBINATION 401.....	60
COLOURS & MATERIALS.....	61
GENERAL TERMS OF SALE AND DELIVERY.....	62
FABRIC & LEATHER UPHOLSTERY	62
CARE & MAINTENANCE.....	62
FSC™ CERTIFICATION.....	62
SUSTAINABILITY	62
DOWNLOADS	62
ECOLABELS.....	62

NEW ORDER OVERVIEW

SHELVES

Top, Middle, Bottom
L34 | L100 | L150

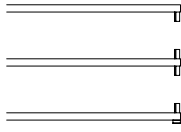

TRAY

Top
L100 | L150



BENCHTOPS

Benchtop L34



Benchtop L100

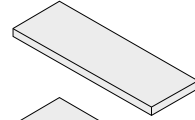

Benchtop L150

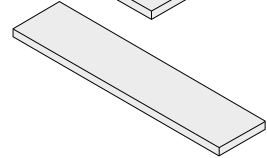

PROFILES

Single profile
for single height
Set of 4
H33 cm



Double profile
for single height
Set of 2
H33 cm



Corner profile
for single height
Set of 1 x triple
1 x single
H33 cm



Single profile
for double height
Set of 4
H68 cm



Double profile
for double height
Set of 2
H68 cm

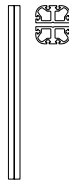

Corner profile
for double height
Set of 1 x triple
1 x single
H68 cm

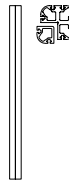

STEEL PANEL

L34 Single height
Standard



L34 Double height
Standard

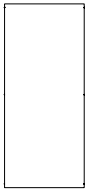

L34 Double height
for adjustable shelf

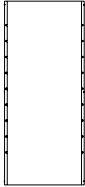

L100 Single height
Standard

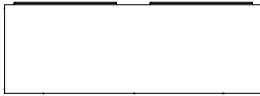

L100 Double height
Standard



L150 Single height
Standard



L150 Double height
Standard



STEEL PANEL | TABLE

L34 Single height
Table



L34 Double height
Table

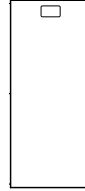

L34 Double height
Table
for adjustable shelf

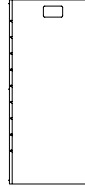

L100 Single height
Table

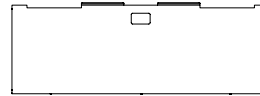

L100 Double height
Table

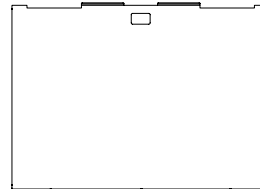

L150 Single height
Table



L150 Double height
Table

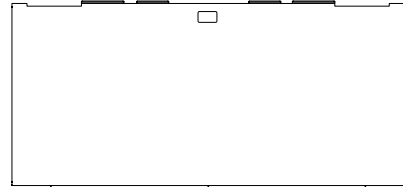

**STEEL SHELF FOR ADJUSTABLE
SIDE PANELS**

Steel shelf L100



STEEL PANEL | WALL

L100 Single height
Wall



L100 Double height
Wall



L150 Single height
Wall



L150 Double height
Table



PINS FOR ADJUSTABLE SHELF

Set of 4

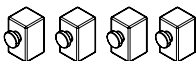

STEEL PANEL | PERFORATED

L100 Single height
Standard Perforated

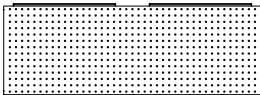

L100 Double height
Standard Perforated

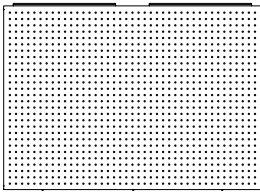

L150 Single height
Standard Perforated

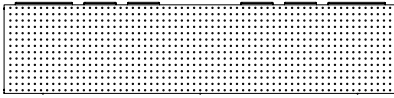

FITTINGS

Mounting adapter tray

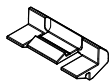

Back panel fastener
adapter tray

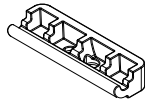

TEXTILE PANEL

L34 Single height
Textile



L34 Double height
Textile



L100 Single height
Textile



L100 Double height
Textile



L150 Single height
Textile



STEEL SLIDING DOOR

L100 | Steel Sliding door |
Single height

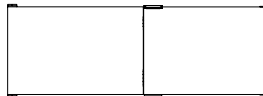

L100 | Steel Sliding door
Corner Prepared f/ Lock |
Single height

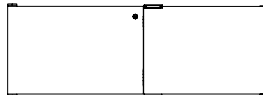

L150 | Steel Sliding door |
Single height Left



L150 | Steel Sliding
door Prepared f/ Lock |
Single height Left

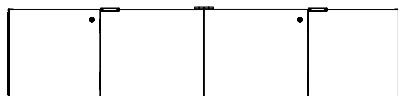

L100 | Steel Sliding door |
Double height

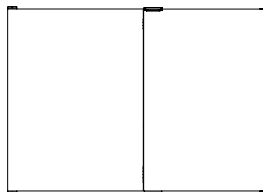

L100 | Steel Sliding door
Corner Prepared f/ Lock |
Double height

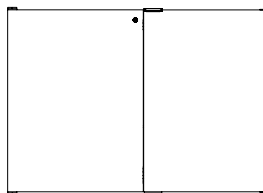

L100 | Steel Sliding door
Corner | Single height

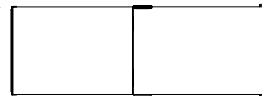

L100 | Steel Sliding
door Prepared f/ Lock |
Single height

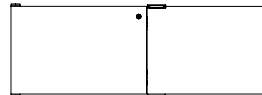

L100 | Steel Sliding
door Prepared f/ Lock |
Double height

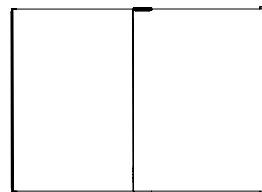

L100 | Steel Sliding door
Corner | Double height

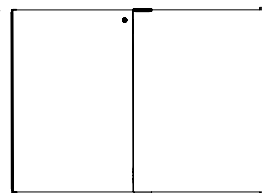

STEEL DRAWERS

High Drawer L34
Set of 1

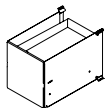

High Drawer L34
Double height
Set of 2

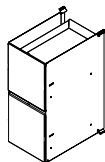

High Drawer L100
Set of 1

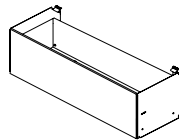

High Drawer L100
Double height
Set of 2

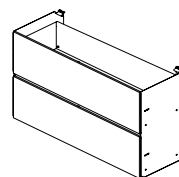

Drawer L34
Set of 2

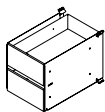

Drawer L34
Double height
Set of 4

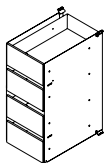

Drawer L100
Set of 2

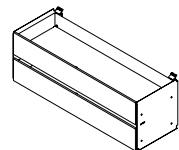

Drawer L100
Double height
Set of 4

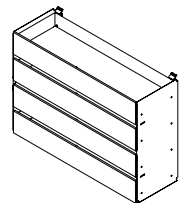

MIDDLE BARS FOR DRAWERS

Steel Middle bar for drawer

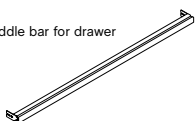

Steel Lock bar for drawer

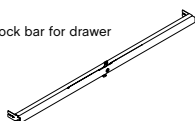

LOCK SYSTEM

Extra lock cylinder



Master key



Extra Key for lock cylinder



Exchange key



SAFETY BRACKETS

Wall safety brackets
Set of 2

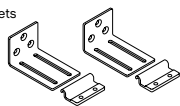

Floor safety brackets
Set of 2

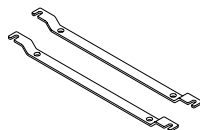

FITTINGS WALL BRACKET

Wall bracket shelf
Set of 2

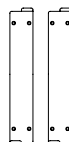

Wall bracket for
double height shelf
Set of 2

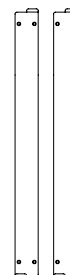

ACCESSORIES

Repair Kit



Wheels
Set of 4

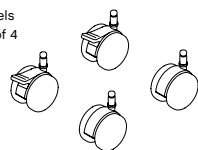

Book Divider
left or right

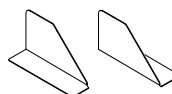

TROLLEYS

Trolley A | 1 drawer w/ Lock

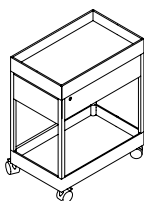

Trolley B | 3 drawer w/ Lock

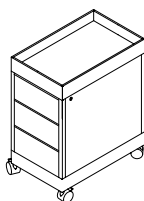

TABLE LEGS

New order tables can be connected to the shelves with table connectors. The tables are available with 1, 2, 3 or 4 legs

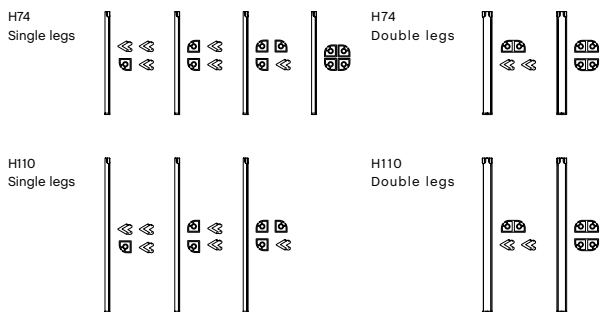
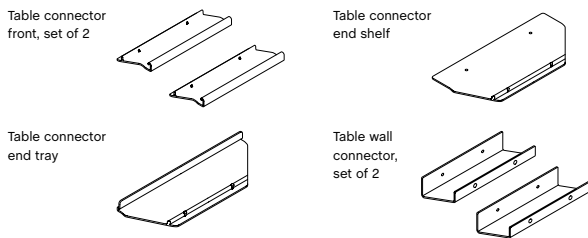
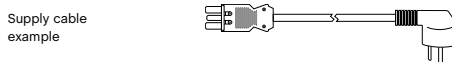
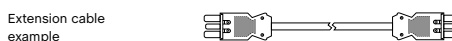
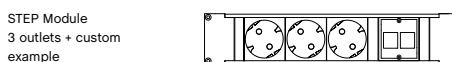
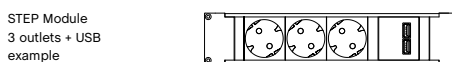
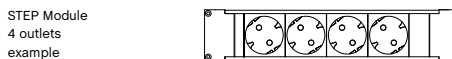
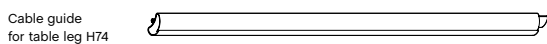
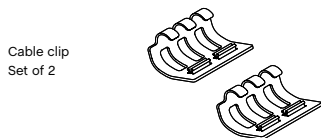
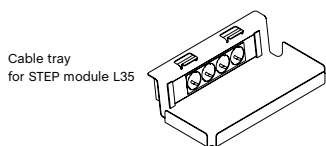
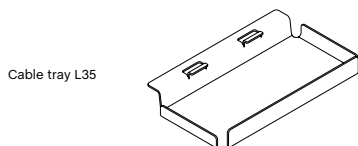

TABLE CONNECTORS



CABLE MANAGEMENT ACCESSORIES



COVERS

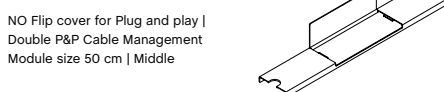
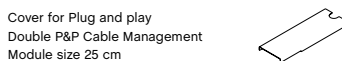
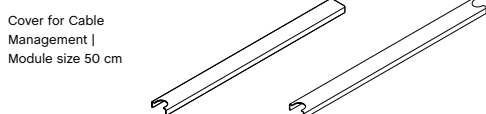
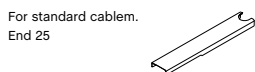
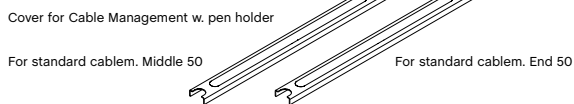

CABLE MANAGEMENT AND TABLE SCREEN OVERVIEW

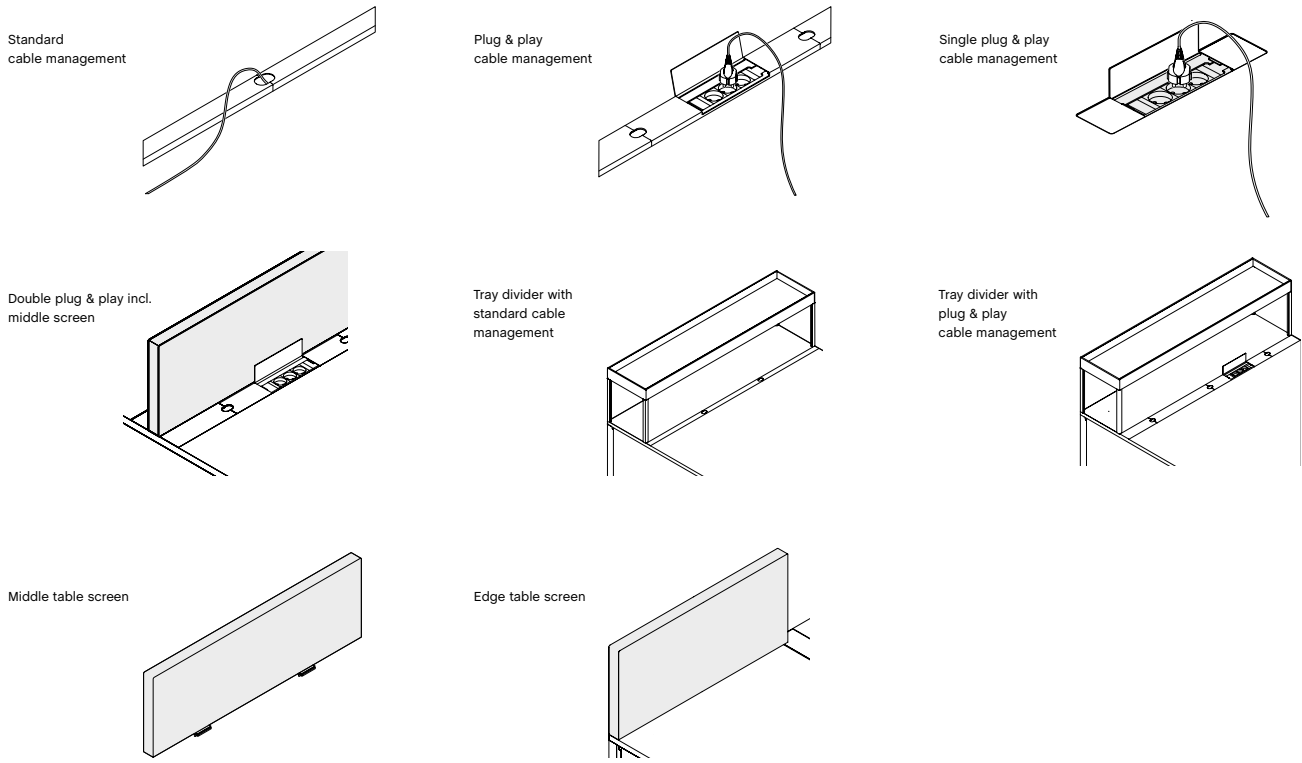

TABLE SCREENS

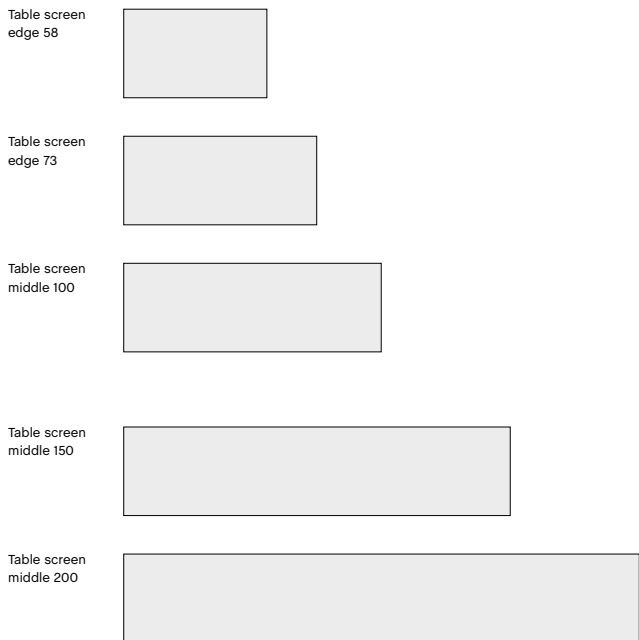

TABLE OVERVIEW

100 x 50



1A

100 x 100

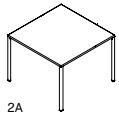

2A

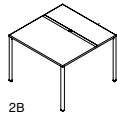

2B

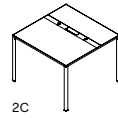

2C

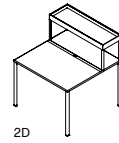

2D

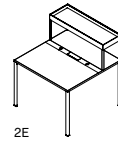

2E

100 x 150

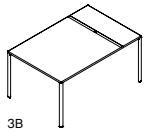

3B

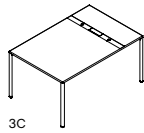

3C

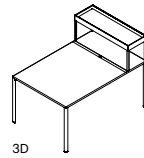

3D

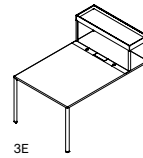

3E

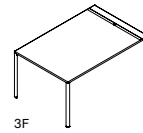

3F

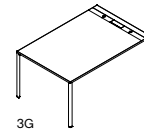

3G

150 x 50

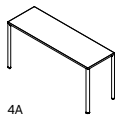

4A

150 x 75

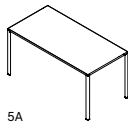

5A

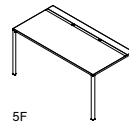

5F

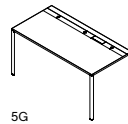

5G

150 x 100

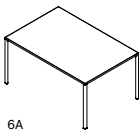

6A

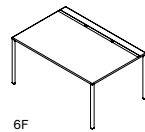

6F

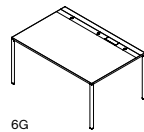

6G

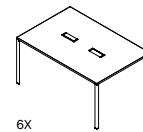

6X

150 x 150

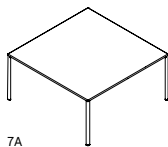

7A

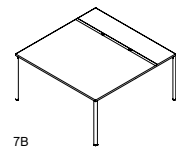

7B

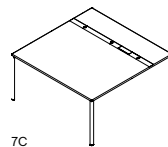

7C

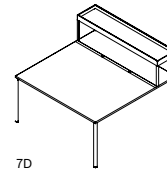

7D

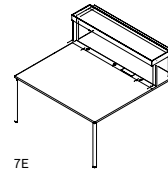

7E

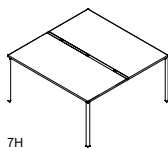

7H

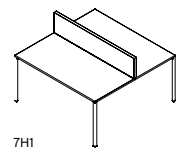

7H1

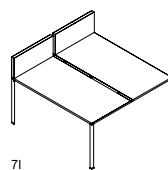

7I

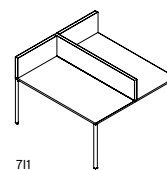

7I1

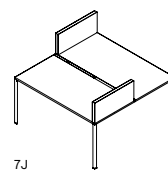

7J

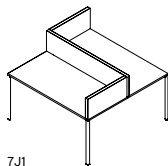

7J1

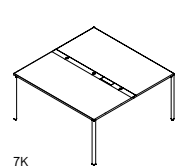

7K

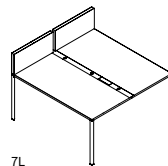

7L

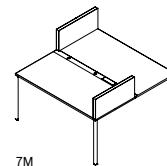

7M

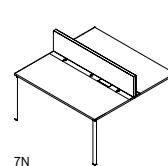

7N

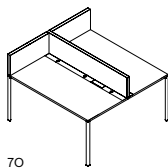

7O

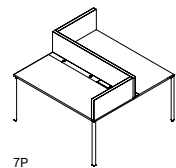

7P

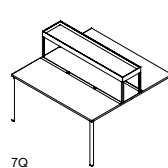

7Q

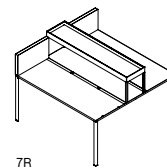

7R

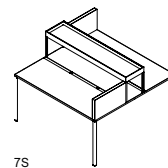

7S

TABLE OVERVIEW

150 x 150

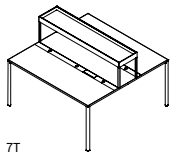

7T

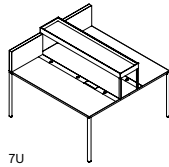

7U

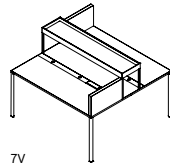

7V

200 x 75

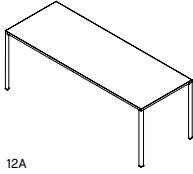

12A

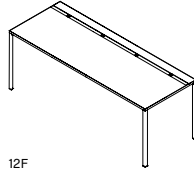

12F

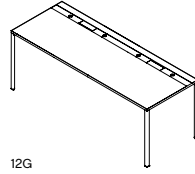

12G

200 x 100

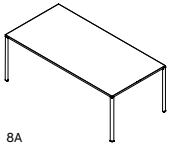

8A

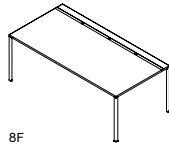

8F

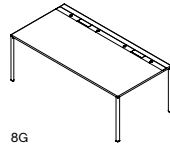

8G

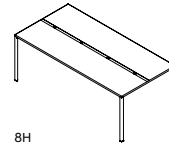

8H

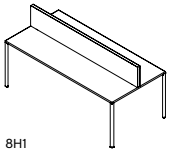

8HI

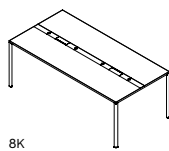

8K

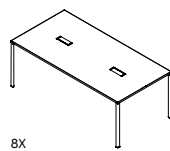

8X

200 x 150

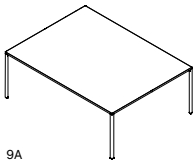

9A

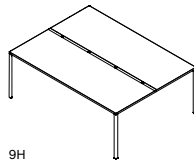

9H

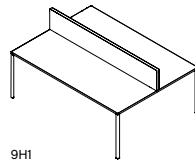

9HI

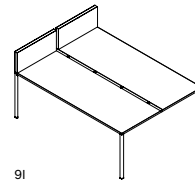

9I

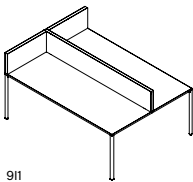

9II

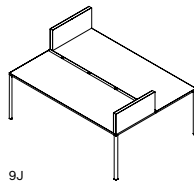

9J

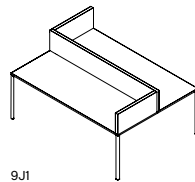

9JI

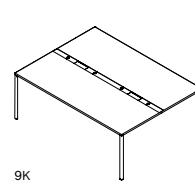

9K

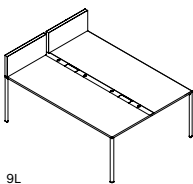

9L

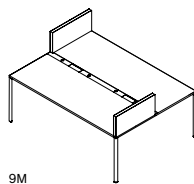

9M

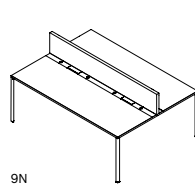

9N

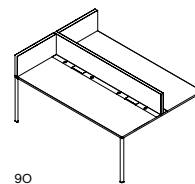

9O

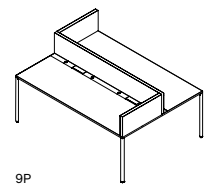

9P

250 x 100

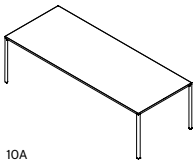

10A

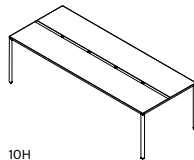

10H

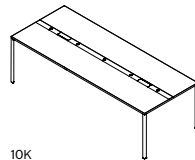

10K

300 x 100

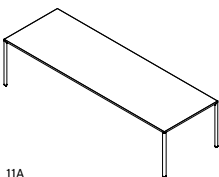

11A

HIGH TABLE OVERVIEW

100 x 150

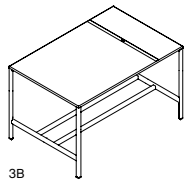

3B

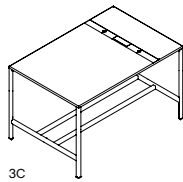

3C

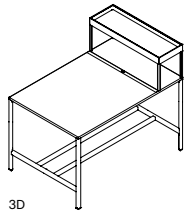

3D

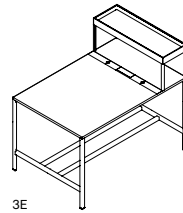

3E

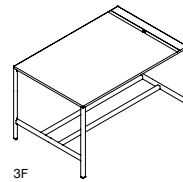

3F

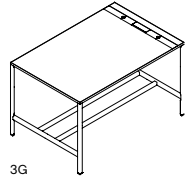

3G

150 x 75

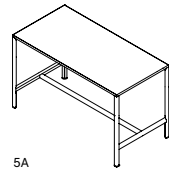

5A

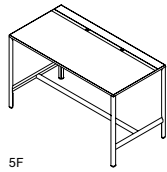

5F

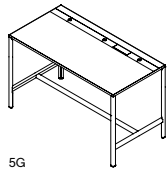

5G

150 x 100

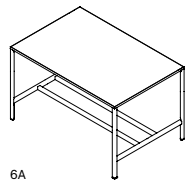

6A

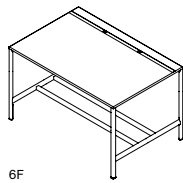

6F

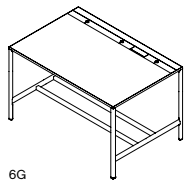

6G

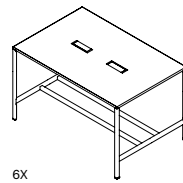

6X

200 x 100

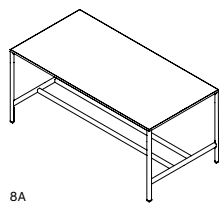

8A

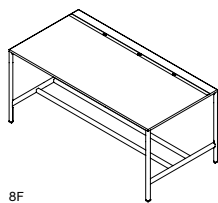

8F

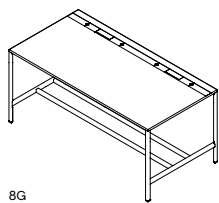

8G

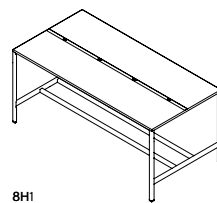

8H1

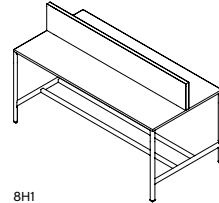

8H1

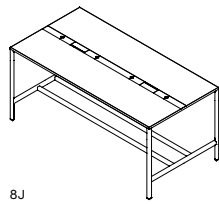

8J

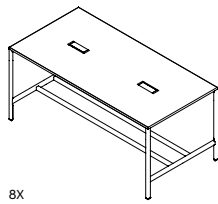

8X

200 x 75

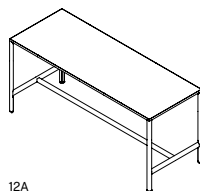

12A

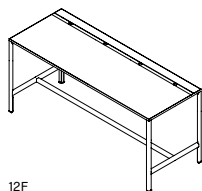

12F

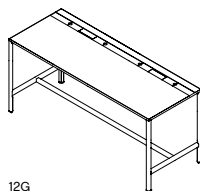

12G

TABLETOP OVERVIEW

100 x 50

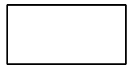

1A

100 x 100

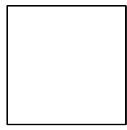

2A

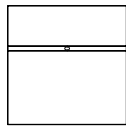

2B

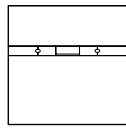

2C

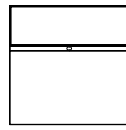

2D

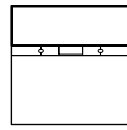

2E

100 x 150

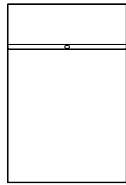

3B

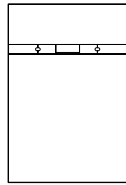

3C

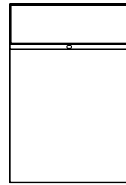

3D

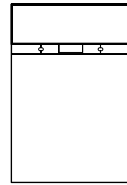

3E



3F

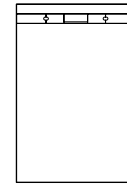

3G

150 x 50

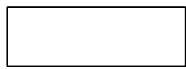

4A

150 x 75



5A

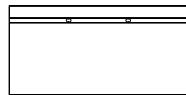

5F

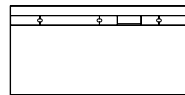

5G

150 x 100



6A

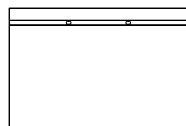

6F

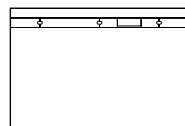

6G

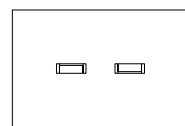

6X

150 x 150

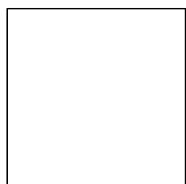

7A

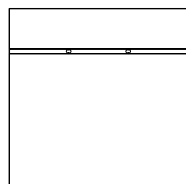

7B

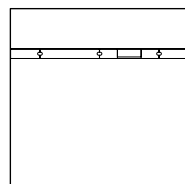

7C

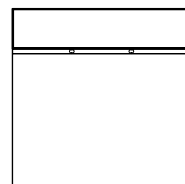

7D

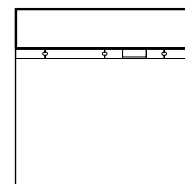

7E

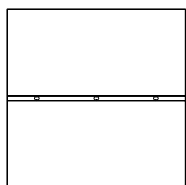

7H

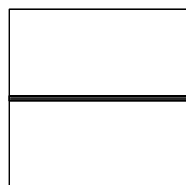

7H1

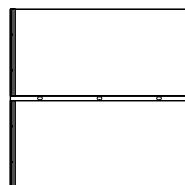

7I

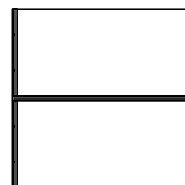

7I1

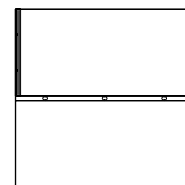

7J

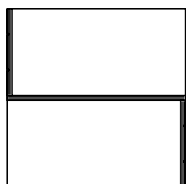

7J1

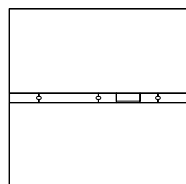

7K

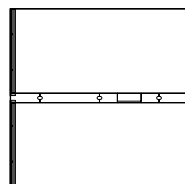

7L

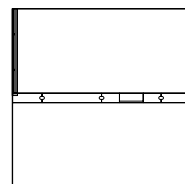

7M

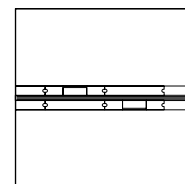

7N

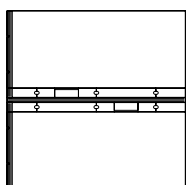

7O

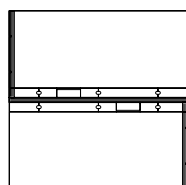

7P

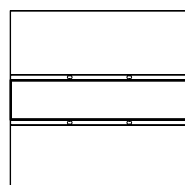

7Q

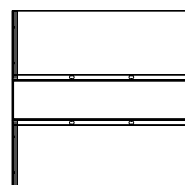

7R

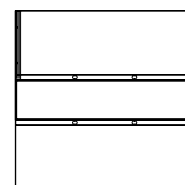

7S

TABLETOP OVERVIEW

150 x 150

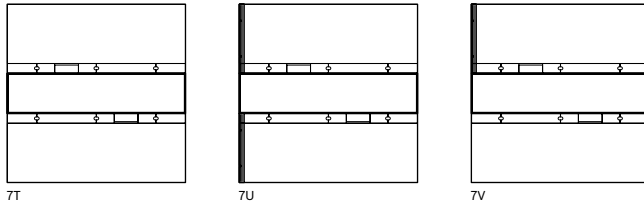

7T

7U

7V

200 x 100

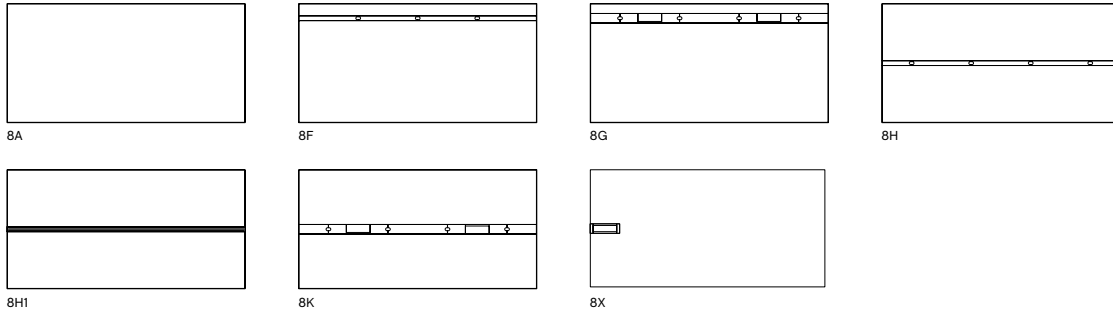

8A

8F

8G

8H

8H1

8K

8X

200 x 150

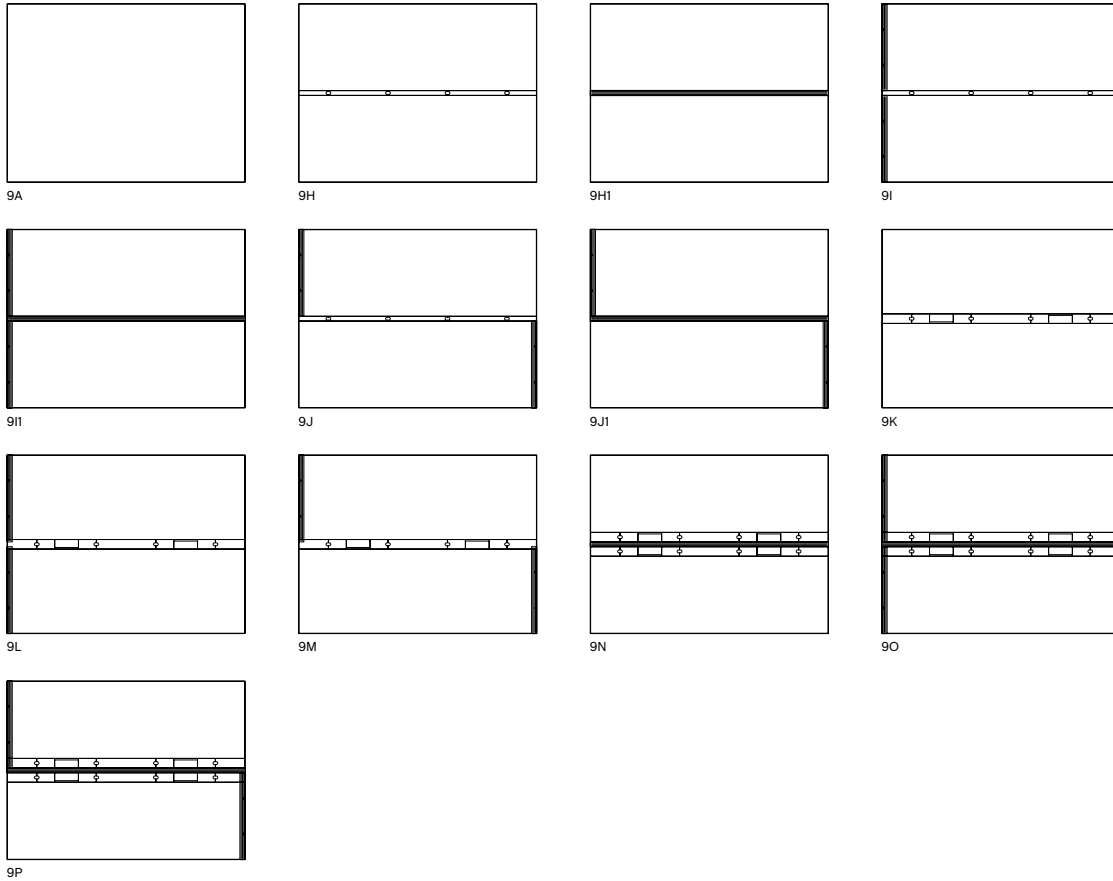

9A

9H

9H1

9I

9I1

9J

9J1

9K

9L

9M

9N

9O

9P

250 x 100

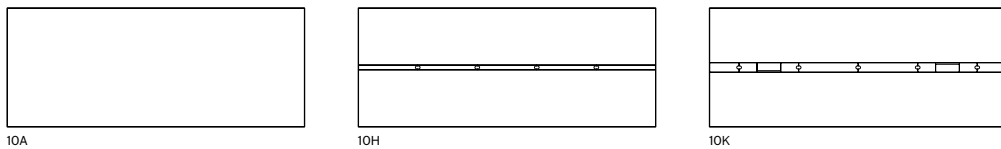

10A

10H

10K

300 x 100

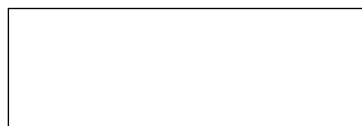

11A

SUGGESTED COMBINATIONS

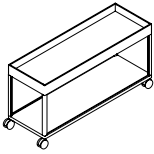

NO Combination 101

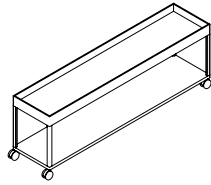

NO Combination 102

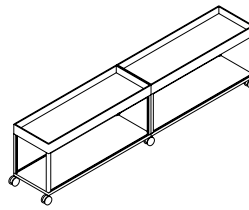

NO Combination 103

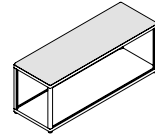

NO Bench combination 100

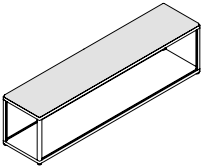

NO Bench combination 150

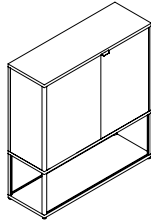

NO Combination 201

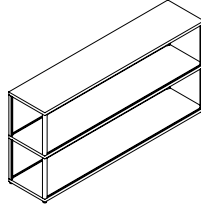

NO Combination 202

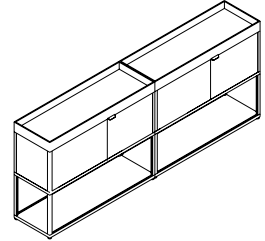

NO Combination 203

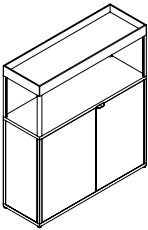

NO Combination 204

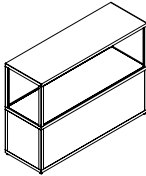

NO Combination 205

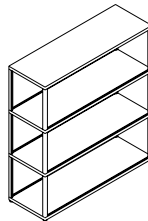

NO Combination 301

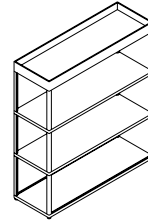

NO Combination 303

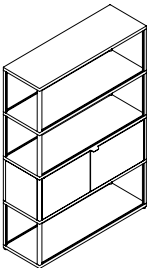

NO Combination 401

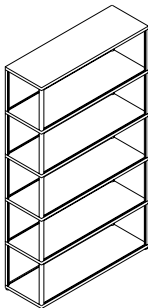

NO Combination 501

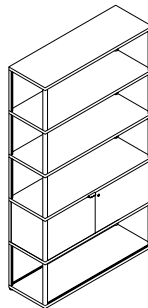

NO Combination 502

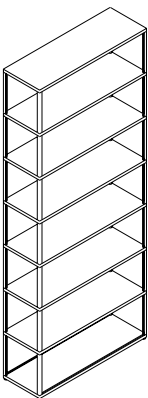

NO Combination 701

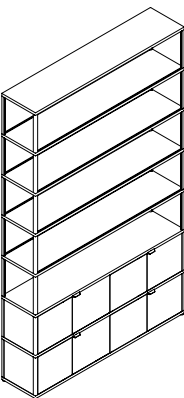

NO Combination 702

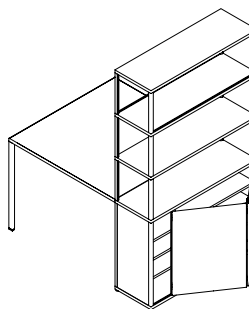

NO Table Combination 401

DIMENSIONS

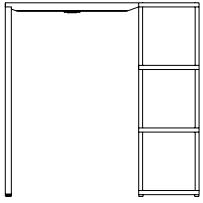

H110 cm

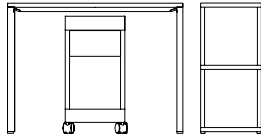

H68 cm

H74 cm

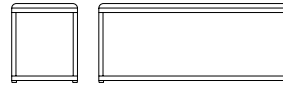

H45 cm

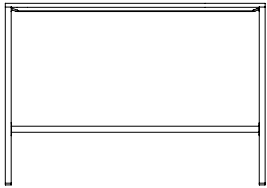

H105 cm

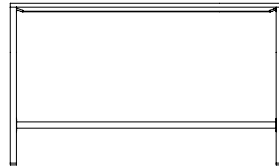

H95 cm

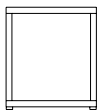

H38,5 cm

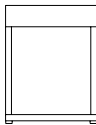

H44,5 cm

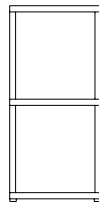

H74 cm



H79,5 cm

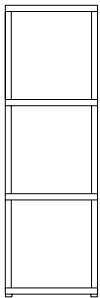

H110 cm

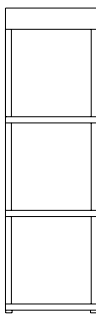

H115 cm

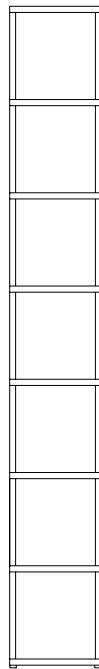

H250 cm

SHELF

23 mm shelf. Powder coated extruded aluminium. End parts in die cast aluminium.
Please note that wall- or floor safety brackets are needed above a certain height.
Please see the New Order instruction manuals for further information or contact our sales team.

Stock item



MATERIAL	COLOUR			
	Army	Charcoal	Light grey	Red
Powder coated extruded aluminium	•	•	•	•

VARIANT	DIMENSION	BOX DIMENSION WEIGHT	PACKAGING	PRICE
34 cm Top	W34 x D34 x H2,3 cm	W39 x D39,5 x H10,5 cm 2,31 kg	1 box 1 pcs.	1.000,00
100 cm Top	W100 x D34 x H2,3 cm	W105 x D39,5 x H10,5 cm 6,4 kg	1 box 1 pcs.	1.920,00
150 cm Top	W150 x D34 x H2,3 cm	W155 x D39,5 x H10,5 cm 9,1 kg	1 box 1 pcs.	2.760,00

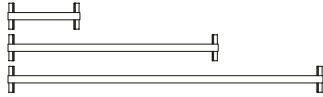

VARIANT	DIMENSION	BOX DIMENSION WEIGHT	PACKAGING	PRICE
34 cm Middle	W34 x D34 x H2,3 cm	W39 x D39,5 x H14 cm 2,46 kg	1 box 1 pcs.	1.000,00
100 cm Middle	W100 x D34 x H2,3 cm	W105 x D39,5 x H14 cm 6,63 kg	1 box 1 pcs.	1.920,00
150 cm Middle	W150 x D34 x H2,3 cm	W155 x D39,5 x H14 cm 9,18 kg	1 box 1 pcs.	2.760,00

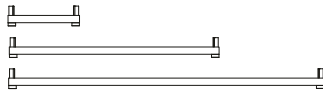

VARIANT	DIMENSION	BOX DIMENSION WEIGHT	PACKAGING	PRICE
34 cm Bottom Incl. adjustable feet.	W34 x D34 x H2,3 cm	W39 x D39,5 x H10,5 cm 2,42 kg	1 box 1 pcs.	1.000,00
100 cm Bottom Incl. adjustable feet.	W100 x D34 x H2,3 cm	W105 x D39,5 x H10,5 cm 6,21 kg	1 box 1 pcs.	1.920,00
150 cm Bottom Incl. adjustable feet.	W150 x D34 x H2,3 cm	W155 x D39,5 x H10,5 cm 9 kg	1 box 1 pcs.	2.760,00

TRAY

80 mm tray. Powder coated aluminum sides with steel bottom. End parts in die cast aluminium.
Please note that wall- or floor safety brackets are needed above a certain height.
Please see the New Order instruction manuals for further information or contact our sales team.

Stock item

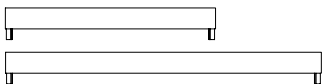

MATERIAL	COLOUR			
	Army	Charcoal	Light grey	Red
Powder coated extruded aluminium	•	•	•	•

VARIANT	DIMENSION	BOX DIMENSION WEIGHT	PACKAGING	PRICE
100 cm Top	W100 x D34 x H8 cm	W105 x D39,5 x H16 cm 5,92 kg	1 box 1 pcs.	2.040,00
150 cm Top	W150 x D34 x H8 cm	W155 x D39,5 x H16 cm 8,3 kg	1 box 1 pcs.	2.880,00

PROFILE

Powder coated extruded aluminium. Incl. Premounted set screws. Single or double height.

Stock item

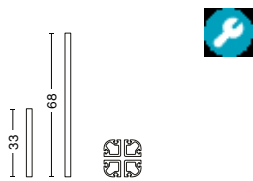

MATERIAL	COLOUR			
	Powder coated extruded aluminium	Army	Charcoal	Light grey

VARIANT	DIMENSION	BOX DIMENSION WEIGHT	PACKAGING	PRICE
Single Set of 4 Single height	W2,2 x D2,2 x H33 cm	W34,5 x D5,5 x H5,5 cm 0,87 kg	1 box 1 pcs.	432,00
Single Set of 4 Double height	W2,2 x D2,2 x H68 cm	W70 x D5,5 x H5,5 cm 1,8 kg	1 box 1 pcs.	800,00

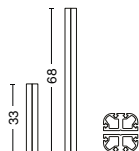

VARIANT	DIMENSION	BOX DIMENSION WEIGHT	PACKAGING	PRICE
Double Set of 2 Single height	W2,2 x D2,2 x H33 cm	W34,5 x D5,5 x H5,5 cm 0,87 kg	1 box 1 pcs.	432,00
Double Set of 2 Double height	W2,2 x D2,2 x H68 cm	W70 x D5,5 x H5,5 cm 1,8 kg	1 box 1 pcs.	800,00

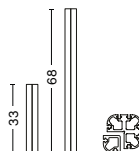

VARIANT	DIMENSION	BOX DIMENSION WEIGHT	PACKAGING	PRICE
Corner Set of 1 x triple & 1 x single Single height	W2,2 x D2,2 x H33 cm	W34,5 x D5,5 x H5,5 cm 0,87 kg	1 box 1 pcs.	432,00
Corner Set of 1 x triple & 1 x single Double height	W2,2 x D2,2 x H68 cm	W70 x D5,5 x H5,5 cm 1,8 kg	1 box 1 pcs.	800,00

BENCHTOP

MDF board with foam top upholstered with fabric or leather. Premounted with velcro for mounting. Please note shelving below benchtop should be open without panels, drawers or doors.

Order produced



VARIANT	DIMENSION	BOX DIMENSION WEIGHT	PACKAGING	PRICE
L34	W34 x D34 x H2,3 cm	W39 x D36 x H30 cm 2 kg	1 box 1 pcs.	Remix 1.040,00 Surface by HAY 1.040,00 Steelcut 1.120,00 Steelcut Trio 1.120,00 Canvas 1.200,00 Sierra Black leather 1.520,00 Sense Cognac leather 1.960,00

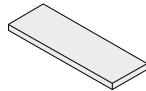

VARIANT	DIMENSION	BOX DIMENSION WEIGHT	PACKAGING	PRICE
L100	W100 x D34 x H2,3 cm	W105 x D36 x H5 cm 3 kg	1 box 1 pcs.	Remix 2.120,00 Surface by HAY 2.120,00 Steelcut 2.240,00 Steelcut Trio 2.240,00 Canvas 2.360,00 Sierra Black leather 2.880,00 Sense Cognac leather 3.680,00

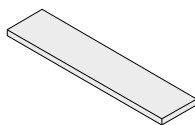

VARIANT	DIMENSION	BOX DIMENSION WEIGHT	PACKAGING	PRICE
L150	W150 x D34 x H2,3 cm	W155 x D36 x H5 cm 3,5 kg	1 box 1 pcs.	Remix 3.040,00 Surface by HAY 3.040,00 Steelcut 3.240,00 Steelcut Trio 3.240,00 Canvas 3.440,00 Sierra Black leather 4.280,00 Sense Cognac leather 5.520,00

STEEL PANEL

Powder coated steel. Adjustable shelves are ordered separately.

Order produced

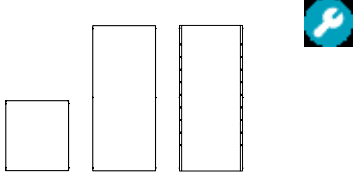

MATERIAL	COLOUR		
	Army	Charcoal	Light grey
Powder coated extruded aluminium	•	•	•

VARIANT	DIMENSION	BOX DIMENSION WEIGHT	PACKAGING	PRICE
L34 Single height Standard	W29,5 x D1,6 x H33 cm	W29,5 x D1,6 x H33 cm 1,5 kg	1 box 1 pcs.	424,00
L34 Double height Standard	W29,5 x D1,6 x H68 cm	W29,5 x D1,6 x H68 cm 3 kg	1 box 1 pcs.	703,20
L34 Double height for adjustable shelf	W29,5 x D1,6 x H68 cm	W29,5 x D1,6 x H68 cm 3 kg	1 box 1 pcs.	840,00

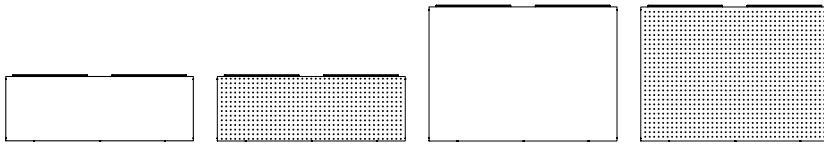

VARIANT	DIMENSION	BOX DIMENSION WEIGHT	PACKAGING	PRICE
L100 Single height Standard	W95,5 x D1,6 x H33 cm	W95,5 x D1,6 x H33 cm 4,5 kg	1 box 1 pcs.	703,20
L100 Single height Standard Perforated	W95,5 x D1,6 x H33 cm	W95,5 x D1,6 x H33 cm 4,5 kg	1 box 1 pcs.	1.240,00
L100 Double height Standard	W95,5 x D1,6 x H68 cm	W95,5 x D1,6 x H68 cm 9 kg	1 box 1 pcs.	1.120,00
L100 Double height Standard Perforated	W95,5 x D1,6 x H68 cm	W95,5 x D1,6 x H68 cm 9 kg	1 box 1 pcs.	1.960,00

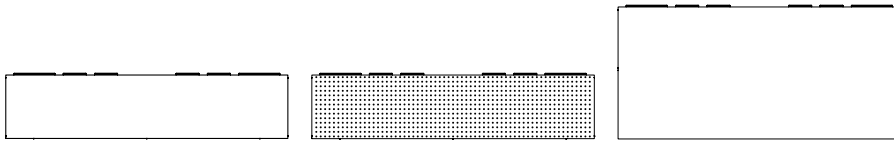

VARIANT	DIMENSION	BOX DIMENSION WEIGHT	PACKAGING	PRICE
L150 Single height Standard	W145,5 x D1,6 x H33 cm	W145,5 x D1,6 x H33 cm 7 kg	1 box 1 pcs.	1.400,00
L150 Single height Standard Perforated	W145,5 x D1,6 x H33 cm	W145,5 x D1,6 x H33 cm 7 kg	1 box 1 pcs.	2.120,00
L150 Double height Standard	W145,5 x D1,6 x H68 cm	W145,5 x D1,6 x H68 cm 13 kg	1 box 1 pcs.	2.120,00

STEEL SHELF FOR ADJUSTABLE SIDE PANELS

1,25 mm shelf in powder coated steel. Incl. 4 pins in POM.

Order produced



MATERIAL	COLOUR		
	Army	Charcoal	Light grey
Powder coated steel	•	•	•

VARIANT	DIMENSION	BOX DIMENSION WEIGHT	PACKAGING	PRICE
L100	W95,5 x D34 x H2,2 cm	W95,5 x D34 x H2,2 cm 4,5 kg	1 box 1 pcs.	840,00

PINS FOR ADJUSTABLE SHELF | SET OF 4

Set of 4 pins in POM

Stock



MATERIAL	COLOUR		
	Army	Charcoal	Light grey
POM	•	•	•

VARIANT	DIMENSION	BOX DIMENSION WEIGHT	PACKAGING	PRICE
SET OF 4	W5 x D5 x H1 cm	W5 x D5 x H1 cm 0,04 kg	1 box 1 pcs.	120,00

STEEL PANEL | WALL

Powder coated steel. With cutouts for wall brackets.
Adjustable shelves are ordered separately.

Order produced

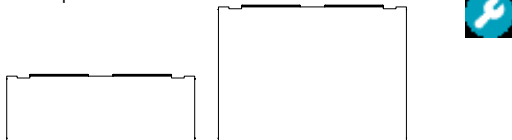

MATERIAL	COLOUR		
	Army	Charcoal	Light grey
Powder coated steel	•	•	•

VARIANT	DIMENSION	BOX DIMENSION WEIGHT	PACKAGING	PRICE
L100 Single height Wall	W95,5 x D1,6 x H33 cm	W95,5 x D1,6 x H33 cm 4,5 kg	1 box 1 pcs.	840,00
L100 Double height Wall	x D x H cm	x D x H cm kg	1 box 1 pcs.	1.120,00

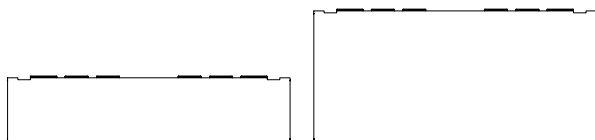

VARIANT	DIMENSION	BOX DIMENSION WEIGHT	PACKAGING	PRICE
L150 Single height Wall	W145,5 x D1,6 x H33 cm	W145,5 x D1,6 x H33 cm 7 kg	1 box 1 pcs.	1.600,00
L150 Double height Wall	W145,5 x D1,6 x H68 cm	W145,5 x D1,6 x H68 cm 13 kg	1 box 1 pcs.	2.240,00

STEEL PANEL | TABLE

Powder coated steel. Used under the tables when connecting tables
with shelf or tray units. Incl. cutout for cables

Order produced

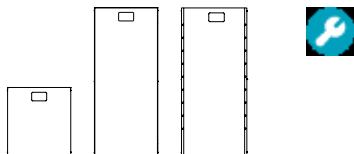

MATERIAL	COLOUR		
	Army	Charcoal	Light grey
Powder coated steel	•	•	•

VARIANT	DIMENSION	BOX DIMENSION WEIGHT	PACKAGING	PRICE
L34 Single height Table	W29,5 x D1,6 x H32 cm	W29,5 x D1,6 x H32 cm 1,5 kg	1 box 1 pcs.	568,00
L34 Double height Table	W29,5 x D1,6 x H67 cm	W29,5 x D1,6 x H67 cm 3 kg	1 box 1 pcs.	1.000,00
L34 Double height Table panels for adjustable	W29,5 x D1,6 x H68 cm	W29,5 x D1,6 x H67 cm 3 kg	1 box 1 pcs.	840,00

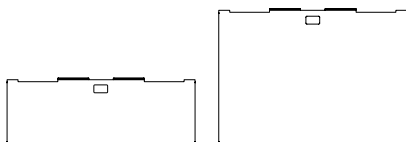

VARIANT	DIMENSION	BOX DIMENSION WEIGHT	PACKAGING	PRICE
L100 Single height Table	W95,5 x D1,6 x H33 cm	W95,5 x D1,6 x H33 cm 4,5 kg	1 box 1 pcs.	840,00
L100 Double height Table	W95,5 x D1,6 x H68 cm	W95,5 x D1,6 x H68 cm 9 kg	1 box 1 pcs.	1.240,00

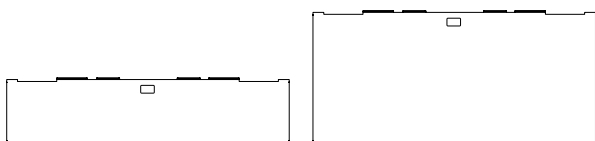

VARIANT	DIMENSION	BOX DIMENSION WEIGHT	PACKAGING	PRICE
L150 Single height Table	W145,5 x D1,6 x H33 cm	W145,5 x D1,6 x H33 cm 7 kg	1 box 1 pcs.	1.600,00
L150 Double height Table	W145,5 x D1,6 x H67 cm	W145,5 x D1,6 x H67 cm 13 kg	1 box 1 pcs.	2.240,00

FITTINGS

Plastic

Stock item

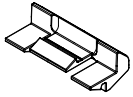

MATERIAL	COLOUR		
	Plastic	Army	Charcoal

VARIANT	DIMENSION	BOX DIMENSION WEIGHT	PACKAGING	PRICE
Mounting adapter tray	W4 x D1 x H1 cm	W5 x D1 x H1 cm 0,02 kg	1 box 1 pcs.	40,00

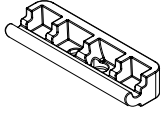

VARIANT	DIMENSION	BOX DIMENSION WEIGHT	PACKAGING	PRICE
Back panel fastener adapter tray	W4 x D1 x H1 cm	W4 x D1 x H1 cm 0,02 kg	1 box 1 pcs.	40,00

TEXTILE PANEL

A foam-filled textile panel insert is mounted with fixed velcro onto a powder coated steel cover used on the outside or inside of the shelving. Textile on one side. Steel cover in army, charcoal or light grey.

Order produced



COVER	COLOUR		
	Army	Charcoal	Light grey
Powder coated steel	•	•	•

VARIANT	DIMENSION	BOX DIMENSION WEIGHT	PACKAGING	FABRIC	PRICE
L34 Single height Side	W29,5 x D1,6 x H68 cm	W29,5 x D1,6 x H33 cm 1,5 kg W29 x D1 x H32,5 cm 0,20 kg	1 box 1 pcs.	Surface by Hay Remix Steelcut Steelcut Trio Canvas	568,00 1.568,00 1.768,00 1.768,00 1.808,00



VARIANT	DIMENSION	BOX DIMENSION WEIGHT	PACKAGING	FABRIC	PRICE
L100 Single height Back	W95,5 x D1,6 x H33 cm	W95,5 x D1,6 x H33 cm 4,5 kg W95 x D1 x H32,5 cm 0,80 kg	1 box 1 pcs.	Surface by Hay Remix Steelcut Steelcut Trio Canvas	840,00 2.680,00 3.080,00 3.080,00 3.200,00



VARIANT	DIMENSION	BOX DIMENSION WEIGHT	PACKAGING	FABRIC	PRICE
L150 Single height Back	W145,5 x D1,6 x H33 cm	W145,5 x D1,6 x H33 cm 7 kg W145 x D1 x H32,5 cm 1,20 kg	1 box 1 pcs.	Surface by Hay Remix Steelcut Steelcut Trio Canvas	1.600,00 3.960,00 4.480,00 4.480,00 4.680,00



VARIANT	DIMENSION	BOX DIMENSION WEIGHT	PACKAGING	FABRIC	PRICE
L34 Double height Side	W29,5 x D1,6 x H68 cm	W29,5 x D1,6 x H68 cm 3 kg W29 cm xD1 x H67,5 cm 0,5 kg	1 box 1 pcs.	Surface by Hay Remix Steelcut Steelcut Trio Canvas	840,00 2.040,00 2.240,00 2.240,00 2.280,00



VARIANT	DIMENSION	BOX DIMENSION WEIGHT	PACKAGING	FABRIC	PRICE
L100 Double height Back	W95,5 x D1,6 x H68 cm	W95,5 x D1,6 x H68 cm 9 kg W95 x D1 x 67,5 cm 1,70 kg	1 box 1 pcs.	Surface by Hay Remix Steelcut Steelcut Trio Canvas	1.240,00 3.280,00 3.680,00 3.680,00 3.800,00

INSIDE TEXTILE PANEL

A foam-filled textile panel insert is mounted with fixed velcro onto a powder coated steel cover used on the outside or inside of the shelving. Textile on one side. Steel cover in army, charcoal or light grey.

Order produced



COVER	COLOUR		
	Army	Charcoal	Light grey
Powder coated steel	•	•	•

VARIANT	DIMENSION	BOX DIMENSION WEIGHT	PACKAGING	FABRIC	PRICE
L34 Single height Side	W29,5 x D1,6 x H68 cm	W29,5 x D1,6 x H33 cm 1,5 kg W29 x D1 x H32,5 cm 0,20 kg	1 box 1 pcs.	Surface by Hay Remix Steelcut Steelcut Trio Canvas	424,00 1.424,00 1.624,00 1.624,00 1.664,00



VARIANT	DIMENSION	BOX DIMENSION WEIGHT	PACKAGING	FABRIC	PRICE
L150 Single height Back	W95,5 x D1,6 x H33 cm	W95,5 x D1,6 x H33 cm 4,5 kg W95 x D1 x H32,5 cm 0,80 kg	1 box 1 pcs.	Surface by Hay Remix Steelcut Steelcut Trio Canvas	424,00 1.424,00 1.624,00 1.624,00 1.664,00



VARIANT	DIMENSION	BOX DIMENSION WEIGHT	PACKAGING	FABRIC	PRICE
L150 Single height Back	W145,5 x D1,6 x H33 cm	W145,5 x D1,6 x H33 cm 7 kg W145 x D1 x H32,5 cm 1,20 kg	1 box 1 pcs.	Surface by Hay Remix Steelcut Steelcut Trio Canvas	1.400,00 3.760,00 4.280,00 4.280,00 4.480,00



VARIANT	DIMENSION	BOX DIMENSION WEIGHT	PACKAGING	FABRIC	PRICE
L34 Double height Side	W29,5 x D1,6 x H68 cm	W29,5 x D1,6 x H68 cm 3 kg W29 cm xD1 x H67,5 cm 0,5 kg	1 box 1 pcs.	Surface by Hay Remix Steelcut Steelcut Trio Canvas	703,20 1.903,20 2.103,20 2.103,20 2.143,20

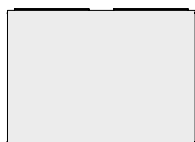

VARIANT	DIMENSION	BOX DIMENSION WEIGHT	PACKAGING	FABRIC	PRICE
L100 Double height Back	W95,5 x D1,6 x H68 cm	W95,5 x D1,6 x H68 cm 9 kg W95 x D1 x 67,5 cm 1,70 kg	1 box 1 pcs.	Surface by Hay Remix Steelcut Steelcut Trio Canvas	1.120,00 3.160,00 3.560,00 3.560,00 3.680,00

STEEL SLIDING DOOR

Powder coated steel. Incl. handle in extruded powder coated aluminium.

100 cm | 1 sliding door opening right or left.

150 cm | 2 sliding doors opening right and left.

Order produced

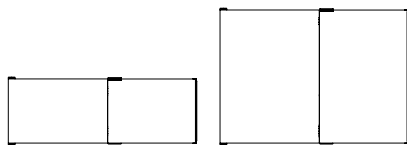

MATERIAL	COLOUR		
	Army	Charcoal	Light grey
Powder coated steel	•	•	•

VARIANT	DIMENSION	BOX DIMENSION WEIGHT	PACKAGING	PRICE
L100 Steel Sliding door Single height	W95,5 x D2,7 x H33 cm	W95,5 x D2,7 x H33 cm 6 kg	1 box 1 pcs.	1.960,00

L100 Steel Sliding door Double height	W95,5 x D2,7 x H68 cm	W95,5 x D2,7 x H68 cm 12 kg	1 box 1 pcs.	3.080,00
---	-----------------------	-------------------------------	----------------	----------

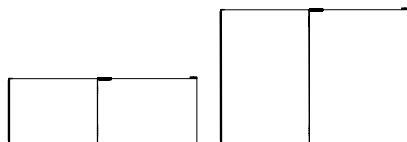

VARIANT	DIMENSION	BOX DIMENSION WEIGHT	PACKAGING	PRICE
L100 Steel Sliding door Corner Single height	W95,5 x D33 x H2,7 cm	W95,5 x D33 x H2,7 cm 6 kg	1 box 1 pcs.	1.960,00

L100 Steel Sliding door Corner Double height	W95,5 x D33 x H2,7 cm	W95,5 x D33 x H2,7 cm 12 kg	1 box 1 pcs.	3.080,00
--	-----------------------	-------------------------------	----------------	----------



VARIANT	DIMENSION	BOX DIMENSION WEIGHT	PACKAGING	PRICE
L150 Steel Sliding door Single height Left	2 x W72,75 x D2,7 x H33 cm	2 pcs. W72,75 x D2,7 x H33 cm 4,5 kg	1 box 1 pcs.	2.798,40

STEEL SLIDING DOOR PREPARED F/ LOCK

Powder coated steel. Incl. handle in extruded powder coated aluminium.

Prepared for Häfele Symo Universal HS 3 locking system, Type 0601-0700. The lock cylinder is packed separately. To be mounted by customer. Master key 210.113 is an option.

Please specify the number of the lock cylinder and the key between 0601-700.

Please note that 2 cylinders are needed for 1 set of L150 cm doors.

Order produced

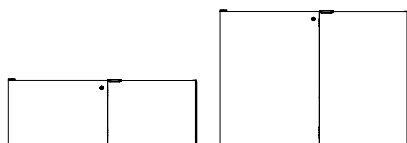

MATERIAL	COLOUR		
	Army	Charcoal	Light grey
Powder coated steel	•	•	•

VARIANT	DIMENSION	BOX DIMENSION WEIGHT	PACKAGING	PRICE
L100 Steel Sliding door Corner Prepared f/ Lock Single height	W95,5 x D2,7 x H33 cm	W95,5 x D33 x H2,7 cm 6 kg	1 box 1 pcs.	2.600,00
L100 Steel Sliding door Corner Prepared f/ Lock Double height	W95,5 x D2,7 x H68 cm	W95,5 x D33 x H2,7 cm 12 kg	1 box 1 pcs.	3.720,00

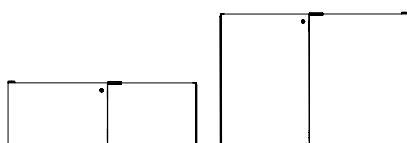

VARIANT	DIMENSION	BOX DIMENSION WEIGHT	PACKAGING	PRICE
L100 Steel Sliding door Prepared f/ Lock Single height	W95,5 x D2,7 x H33 cm	W95,5 x D2,7 x H33 cm 6 kg	1 box 1 pcs.	2.600,00
L100 Steel Sliding door Prepared f/ Lock Double height	W100 x D1 x H68 cm	W100 x D1 x H68 cm 12 kg	1 box 1 pcs.	3.720,00

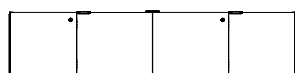

VARIANT	DIMENSION	BOX DIMENSION WEIGHT	PACKAGING	PRICE
L150 Steel Sliding door Prepared f/ Lock Single height Left	2 x W72,75 x D2,7 x H33 cm	2 pcs. W72,75 x D2,7 x H33 cm 4,5 kg	1 box 1 pcs.	4.158,40

ADD-ON FOR LOCK

Lock cylinder For Steel sliding doors and drawers - keys not incl.	W2,5 x D1,5 x H1,5 cm	W5 x D2 x H2 cm 0,1 kg	1 box 1 pcs.	+ 140,00
Key for Lock cylinder For Steel sliding doors and drawers	W2,5 x D1,5 x H0,2 cm	W4 x D1 x H1 cm 0,02 kg	1 box 1 pcs.	+ 104,00

HIGH DRAWER

Powder coated steel. It is possible to post mount lock bar or middle bar on double height drawers set of 2. Set of 2 drawers is used with double height profiles. Set of 1 drawer is used with single height profiles. Please note that all shelving units with drawers require wall- or floor safety brackets. Max load 15 kg. pr. drawer.

Order produced

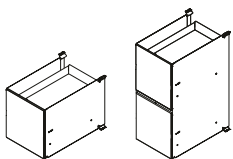

MATERIAL	COLOUR		
	Army	Charcoal	Light grey
Powder coated steel	•	•	•

VARIANT	DIMENSION	PACKAGING	PRICE
High Drawer 34 cm Set of 1 Drawer incl. mounting set	W34 x D48 x H33 cm	1 box 1 pcs.	5.920,00
High Drawer 34 cm Set of 2 incl. double height mounting set	W34 x D48 x H68 cm	1 box 1 pcs.	10.960,00

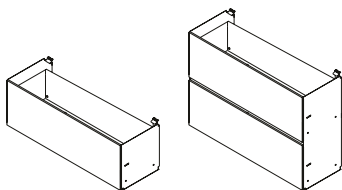

VARIANT	DIMENSION	PACKAGING	PRICE
High Drawer 100 cm Set of 1 Drawer incl. mounting set	W100 x D34 x H33 cm	1 box 1 pcs.	6.480,00
High Drawer 100 cm Set of 2 incl. double height mounting set	W100 x D34 x H68 cm	1 box 1 pcs.	13.040,00

DRAWER

Powder coated steel. It is possible to post mount lock bar or middle bar. Set of 2 drawers is used with single height profiles. Set of 4 drawers is used with double height profiles. Please note that all shelving units with drawers require wall- or floor safety brackets. Max load 15 kg. pr. drawer.

Order produced

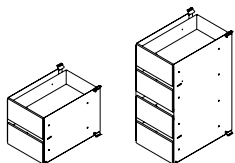

MATERIAL	COLOUR		
	Army	Charcoal	Light grey
Powder coated steel	•	•	•

VARIANT	DIMENSION	PACKAGING	PRICE
Drawer 34 cm Set of 2 incl. mounting set	W34 x D48 x H33 cm	1 box 1 pcs.	8.720,00
Drawer 34 cm Set of 4 incl. double height mounting set	W34 x D48 x H68 cm	1 box 1 pcs.	17.120,00

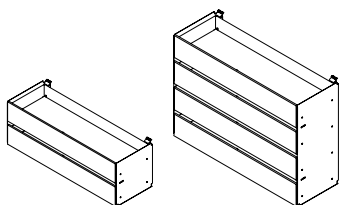

VARIANT	DIMENSION	PACKAGING	PRICE
Drawer 100 cm Set of 2 incl. mounting set	W100 x D34 x H33 cm	1 box 1 pcs.	10.160,00
Drawer 100 cm Set of 4 incl. double height mounting set	W100 x D34 x H68 cm	1 box 1 pcs.	20.000,00

STEEL MIDDLE BAR FOR DRAWER

Powder coated steel. Can be used to close the gap between two drawers.
To be mounted by customer.

Order produced



MATERIAL	COLOUR		
	Army	Charcoal	Light grey
Powder coated steel	•	•	•

VARIANT	DIMENSION	BOX DIMENSION WEIGHT	PACKAGING	PRICE
L34	W29,5 x D6,8 x H2,6 cm	W29,5 x D6,8 x H2,6 cm 1 kg	1 box 1 pcs.	703,20
L100	W95,5 x D6,8 x H2,6 cm	W95,5 x D6,8 x H2,6 cm 2,5 kg	1 box 1 pcs.	920,00

STEEL LOCK BAR FOR DRAWER

Powder coated steel. Can be used to close the gap between two drawers. Please note for set of 4 drawers only 2 lock bars and 1 middle bar. Prepared for Häfele Symo Universal HS 3 locking system, Type 0601-0700. The lock cylinder is packed separately. To be mounted by customer. Master key 210.113 is an option. Please specify the number of the lock cylinder and the key between 0601-700.

Order produced



MATERIAL	COLOUR		
	Army	Charcoal	Light grey
Powder coated steel	•	•	•

VARIANT	DIMENSION	BOX DIMENSION WEIGHT	PACKAGING	PRICE
L34	W29,5 x D6,8 x H2,6 cm	W29,5 x D6,8 x H2,6 cm 1 kg	1 box 1 pcs.	1.120,00
L100	W95,5 x D6,8 x H2,6 cm	W95,5 x D6,8 x H2,6 cm 2,5 kg	1 box 1 pcs.	1.320,00

ADD-ON FOR LOCK

Lock cylinder For Steel sliding doors and drawers - keys not incl.	W2,5 x D1,5 x H1,5 cm	W5 x D2 x H2 cm 0,1 kg	1 box 1 pcs.	+ 140,00
Key for Lock cylinder For Steel sliding doors and drawers	W2,5 x D1,5 x H0,2 cm	W4 x D1 x H1 cm 0,02 kg	1 box 1 pcs.	+ 104,00

LOCK CYLINDER

Lock cylinder core for left or right hand use. Nickel plated zinc alloy housing, brass plate levers.
Standard locking system - Häfele Symo Universal HS 3, Type 0601-0700. Häfele item no. 210.41.603.
Please specify the number of the lock cylinder and the key between 0601-700. Master key is an option.

Order produced



VARIANT	DIMENSION	PACKAGING	PRICE
Lock cylinder For Steel sliding doors and drawers - keys not incl.	W2,5 x D1,5 x H1,5 cm	1 box 1 pcs.	140,00

EXTRA KEY FOR LOCK CYLINDER

Key for lock cylinder. Nickel-plated steel. Standard locking system - Häfele Symo Universal HS 3, Type 0601-0700. Häfele item no 210.11.058. Please specify the number of the lock cylinder and the key between 0601-700. Master key is an option.

Order produced

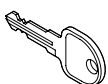

VARIANT	DIMENSION	PACKAGING	PRICE
Key for Lock cylinder For Steel sliding doors and drawers	W2,5 x D1,5 x H0,2 cm	1 box 1 pcs.	104,00

MASTER KEY

Master key for Symo Universal cylinder core SYMO 3000-, HS3. Nickel plated steel. Häfele item no. 210.11.003

Order produced

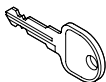

VARIANT	DIMENSION	PACKAGING	PRICE
Master key HS3	W2,5 x D1,5 x H0,2 cm	1 box 1 pcs.	140,00

EXCHANGE KEY FOR LOCK CYLINDER

Exchange key for removing the lock cylinder. Nickel plated steel. Häfele item no. 210.11.090

Order produced

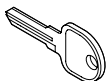

VARIANT	DIMENSION	PACKAGING	PRICE
Exchange key for Lock cylinder For Steel sliding doors and drawers Symo universal	W2,5 x D1,5 x H0,2 cm	1 box 1 pcs.	208,00

FITTINGS WALL BRACKET

Shelf bottom requires shelf wall bracket. Available for wooden- and steel wall panels.

Stock item

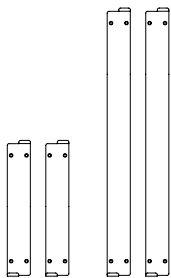

MATERIAL	COLOUR		
	Army	Charcoal	Light grey
Powder coated steel	•	•	•

VARIANT	DIMENSION	BOX DIMENSION WEIGHT	PACKAGING	PRICE
Shelf Single height Set of 2	W36 x D6 x H1 cm	W38 x D8 x H3 cm 0,82 kg	1 box 1 pcs.	208,00
Shelf Double height Set of 2	W71 x D5,5 x H2,5 cm	W5,5 x D2,5 x H71 cm 3,1 kg	1 box 1 pcs.	424,00

FITTINGS SAFETY BRACKET | SET OF 2

Powder coated steel and aluminium. Works with both shelf and tray. Can be used together with wooden wall panels or steel wall panels. Please follow the guidelines in our instruction manuals. It does not work with textile panels. wall screws and plugs are not incl. Max. 40 mm from the wall.

Stock item

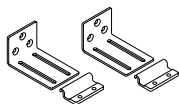

MATERIAL	COLOUR		
	Army	Charcoal	Light grey
Powder coated steel	•	•	•

VARIANT	DIMENSION	BOX DIMENSION WEIGHT	PACKAGING	PRICE
Wall	W4 x D5,5 x H5 cm	W4 x D5,5 x H5 cm 0,7 kg	1 box 1 pcs.	208,00

FITTINGS SAFETY BRACKET | SET OF 2

Powder coated steel. Works with both shelf and tray. Please follow the guidelines in our instruction manuals. Floor screws and plugs are not incl.

Stock item

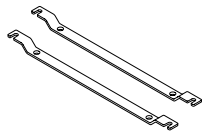

MATERIAL	COLOUR		
	Army	Charcoal	Light grey
Powder coated steel	•	•	•

VARIANT	DIMENSION	BOX DIMENSION WEIGHT	PACKAGING	PRICE
Floor	W40 x D2 x H1,5 cm	W40 x D2 x H1,5 cm 1 kg	1 box 1 pcs.	208,00

REPAIR KIT

Lacquer

Sales QTY.: min. 10 pcs. mix

Stock item



MATERIAL	COLOUR		
	Army	Charcoal	Light grey
Lacquer	•	•	•

VARIANT	DIMENSION	BOX DIMENSION WEIGHT	PACKAGING	PRICE
Repair Kit	W2 x D2 x H6,5 cm	W2 x D2 x H6,5 cm 0,1 kg	1 box 1 pcs.	140,00

WHEELS | SET OF 4

Ø55 mm. Max. height with wheels is 2 layers - 1 bottom and 1 top. Can be mounted on both shelf and tray bottom.

Set of 4 (2 wheels with brake and 2 wheels without).

Stock item

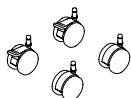

MATERIAL	COLOUR
	Black
Plastic	•

VARIANT	DIMENSION	BOX DIMENSION WEIGHT	PACKAGING	PRICE
Wheels Set of 4 Black	W5,5 x D5,5 x H3,6 cm	W18,5 x D16 x H4,5 cm 0,4 kg	1 box 1 pcs.	424,00

BOOK DIVIDER

Powder coated steel.

Stock item

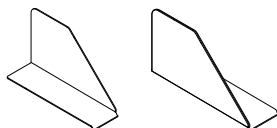

MATERIAL	COLOUR		
	Army	Charcoal	Light grey
Powder coated steel	•	•	•

VARIANT	DIMENSION	BOX DIMENSION WEIGHT	PACKAGING	PRICE
Left	W14 x D9 x H31,3 cm	W35 x D20 x H10 cm 0,7 kg	1 box 1 pcs.	360,00
Right	W14 x D9 x H31,3 cm	W35 x D20 x H10 cm 0,7 kg	1 box 1 pcs.	360,00

TROLLEY A | 1 DRAWER W/ LOCK

Trolley in powder coated steel, die cast extruded aluminium. Incl. 4 x Ø55 mm wheels, 2 with brake.
Incl. Standard locking system - Häfele Symo Universal HS, unsorted numbers.

Stock item

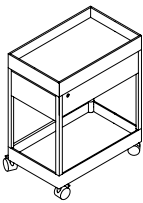

MATERIAL	COLOUR		
	Army	Charcoal	Light grey
Powder coated steel	•	•	•

VARIANT

Trolley A | 1 drawer w/ Lock

DIMENSION

W34 x D55 x H67,5 cm

BOX DIMENSION | WEIGHT

W45 x D66 x H78 cm | 20 kg

PACKAGING

1 box | 1 pcs.

PRICE

7.760,00

TROLLEY B | 3 DRAWER W/ LOCK

Trolley in powder coated steel, die cast extruded aluminium. Incl. 4 x Ø55 mm wheels, 2 with brake.
Incl. Standard locking system - Häfele Symo Universal HS, unsorted numbers.

Stock item

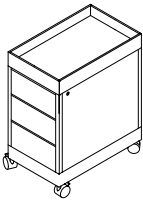

MATERIAL	COLOUR		
	Army	Charcoal	Light grey
Powder coated steel	•	•	•

VARIANT

Trolley B | 3 drawer w/ Lock

DIMENSION

W34 x D55 x H67,5 cm

BOX DIMENSION | WEIGHT

W45 x D66 x H78 cm | 27 kg

PACKAGING

1 box | 1 pcs.

PRICE

10.560,00

TABLE | 4 LEGS

12 mm tabletop in MDF with linoleum or 10 mm tabletop in MDF with veneer.

Tabletop is placed inside the table frame. 4 legs incl. adjustable gliders.

Requires assembly.

Order produced

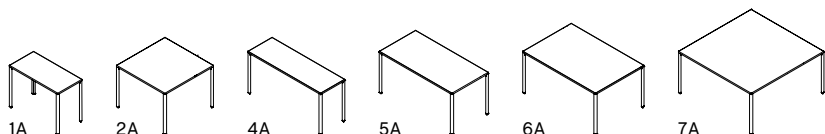

VARIANT	DIMENSION	BOX DIMENSION WEIGHT	PACKAGING	PRICE
1A	L100 x W50 x H74 cm	W163 x D42 x H7,5 cm 7,0 kg W120 x D70 x H2,5 cm 7,3 kg W75 x D27 x H8 cm 11 kg	3 box 1 pcs.	11.040,00
2A	L100 x W100 x H74 cm	W160 x D42 x H16 cm 12 kg W120 x D120 x H2,5 cm 12,9 kg W75 x D27 x H8 cm 11 kg	3 box 1 pcs.	12.800,00
4A	L150 x W50 x H74 cm	W42 x D163 x H15,5 cm 8,5 kg W163,5 x D63,5 x H2,5 cm 9,8 kg W75 x D27 x H8 cm 11 kg	3 box 1 pcs.	13.920,00
5A	L150 x W75 x H74 cm	W160 x D42 x H16 cm 9 kg W163,5 x D88,5 x H2,5 cm 14,6 kg W75 x D27 x H8 cm 11 kg	3 box 1 pcs.	15.160,00
6A	L150 x W100 x H74 cm	W160 x D42 x H16 cm 14 kg W163,5 x D113,5 x H2,5 cm 19,3 kg W75 x D27 x H8 cm 11 kg	3 box 1 pcs.	15.040,00
7A	L150 x W150 x H74 cm	W160 x D42 x H16 cm 18 kg W163,5 x D163,5 x H2,5 cm 28,7 kg W75 x D27 x H8 cm 11 kg	3 box 1 pcs.	17.680,00

FRAME & LEGS	TABLETOP
Army powder coated aluminium	Cloud grey linoleum
Charcoal powder coated aluminium	Dark grey linoleum
Light grey powder coated aluminium	Green linoleum
	Grey linoleum
	Water-based lacquered oak veneer

TABLE | 4 LEGS

12 mm tabletop in MDF with linoleum or 10 mm tabletop in MDF with veneer.

Tabletop is placed inside the table frame. 4 legs incl. adjustable gliders.

Requires assembly.

Order produced

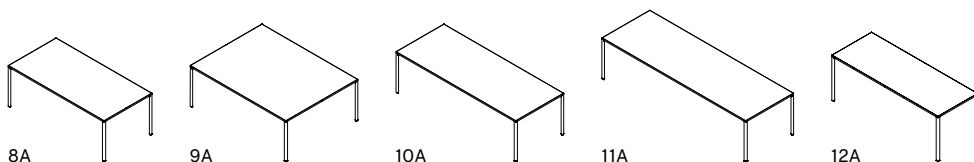

VARIANT	DIMENSION	BOX DIMENSION WEIGHT	PACKAGING	PRICE
8A	L200 x W100 x H74 cm	W210 x D42 x H16 cm 18 kg W214 x D114 x H4,5 cm 32 kg W75 x D27 x H8 cm 6 kg	3 box 1 pcs.	17.520,00
9A	L200 x W75 x H74 cm	W210 x D42 x H16 cm 16 kg W213,5 x D88,5 x H2,5 cm 19,1kg W79 x D27 x H8 cm 11 kg	3 box 1 pcs.	20.280,00
10A	L250 x W100 x H74 cm	W252 x D42 x H16 cm 22 kg W264 x D114 x H4,5 cm 38 kg W75 x D27 x H8 cm 11 kg	3 box 1 pcs.	23.320,00
11A	L300 x W100 x H74 cm	W320 x D20 x H14,5 cm 20 kg W314 x D114 x H4,5 cm 41 kg W75 x D27 x H8 cm 6 kg	3 box 1 pcs.	25.160,00
12A	L200 x W75 x H74 cm	W210 x D42 x H16 cm 16 kg W213,5 x D88,5 x H2,5 cm 19,1kg W79 x D27 x H8 cm 11 kg	3 box 1 pcs.	17.280,00

FRAME & LEGS	TABLETOP
Army powder coated aluminium	Cloud grey linoleum
Charcoal powder coated aluminium	Dark grey linoleum
Light grey powder coated aluminium	Green linoleum
	Grey linoleum
	Water-based lacquered oak veneer

TABLE INCL. SINGLE PLUG & PLAY | 4 LEGS

12 mm tabletop in MDF with linoleum or 10 mm tabletop in MDF with veneer. Incl. 2 x Single Plug & Play Center. Tabletop is placed inside the table frame. 4 legs incl. adjustable gliders. Requires assembly. STEP modules not included.

Order produced

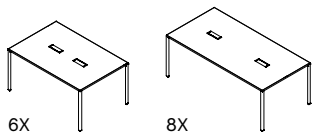

6X

8X

VARIANT	DIMENSION	BOX DIMENSION WEIGHT	PACKAGING	PRICE
6X	L150 x W100 x H74 cm	W160 x D42 x H16 cm 14 kg W163,5 x D113,5 x H2,5 cm 19,3 kg W75 x D27 x H8 cm 11 kg	3 box 1 pcs.	20.760,00
8X	L200 x W100 x H74 cm	W210 x D42 x H16 cm 18 kg W214 x D114 x H4,5 cm 32 kg W75 x D27 x H8 cm 6 kg	3 box 1 pcs.	24.200,00

FRAME & LEGS	TABLETOP
Army powder coated aluminium	Cloud grey linoleum
Charcoal powder coated aluminium	Dark grey linoleum
Light grey powder coated aluminium	Green linoleum
	Grey linoleum
	Water-based lacquered oak veneer

TABLE INCL. CABLE MANAGEMENT EDGE | 4 LEGS

12 mm tabletop in MDF with linoleum or 10 mm tabletop in MDF with veneer. Incl. 40 mm cable management cover. Tabletop is placed inside the table frame. 4 legs incl. adjustable gliders. Requires assembly. STEP modules not included.

Order produced

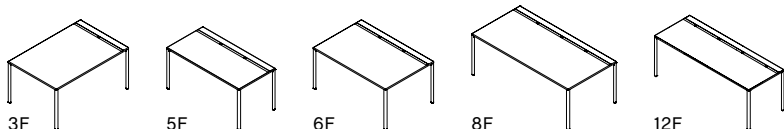

3F

5F

6F

8F

12F

VARIANT	DIMENSION	BOX DIMENSION WEIGHT	PACKAGING	PRICE
3F	L100 x W50 x H74 cm	W160 x D42 x H16 cm 14 kg W164 x D114 x H4,5 cm 26 kg W75 x D27 x H8 cm 6 kg	3 box 1 pcs.	17.400,00
5F	L150 x W75 x H74 cm	W160 x D42 x H16 cm 17 kg W75 x D27 x H8 cm 11 kg W164 x D89 x H4,5 cm 27 kg	3 box 1 pcs.	19.400,00
6F	L150 x W100 x H74 cm	W160 x D42 x H16 cm 16 kg W75 x D27 x H8 cm 11 kg W164 x D114 x H4,5 cm 26 kg	3 box 1 pcs.	19.320,00
8F	L200 x W100 x H74 cm	W202 x D42 x H14,5 cm 16 kg W75 x D27 x H8 cm 6 kg W214 x D114 x H4,5 cm 32 kg	3 box 1 pcs.	19.200,00
12F	L200 x W75 x H74 cm	W210 x D42 x H16 cm 16 kg W213,5 x D88,5 x H2,5 cm 19,1kg W79 x D27 x H8 cm 11 kg	3 box 1 pcs.	22.600,00

FRAME & LEGS	TABLETOP
Army powder coated aluminium	Cloud grey linoleum
Charcoal powder coated aluminium	Dark grey linoleum
Light grey powder coated aluminium	Green linoleum
	Grey linoleum
	Water-based lacquered oak veneer

TABLE INCL. PLUG & PLAY CABLE MANAGEMENT EDGE | 4 LEGS



12 mm tabletop in MDF with linoleum or 10 mm tabletop in MDF with veneer. Incl. 80 mm plug & play cable management cover. Tabletop is placed inside the table frame. 4 legs incl. adjustable gliders. Requires assembly. STEP modules not included.

Order produced

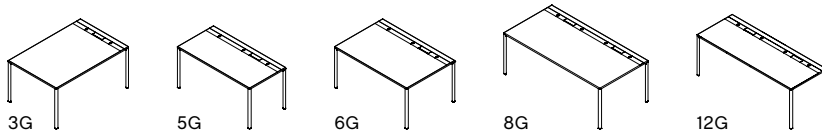

VARIANT	DIMENSION	BOX DIMENSION WEIGHT	PACKAGING	PRICE
3G	L100 x W50 x H74 cm	W160 x D42 x H16 cm 14 kg W164 x D114 x H4,5 cm 26 kg W75 x D27 x H8 cm 6 kg	3 box 1 pcs.	19.320,00
5G	L150 x W75 x H74 cm	W160 x D42 x H16 cm 17 kg W75 x D27 x H8 cm 11 kg W164 x D89 x H4,5 cm 27 kg	3 box 1 pcs.	20.840,00
6G	L150 x W100 x H74 cm	W160 x D42 x H16 cm 16 kg W75 x D27 x H8 cm 11 kg W164 x D114 x H4,5 cm 26 kg	3 box 1 pcs.	20.680,00
8G	L200 x W100 x H74 cm	W202 x D42 x H14,5 cm 16 kg W75 x D27 x H8 cm 6 kg W214 x D114 x H4,5 cm 32 kg	3 box 1 pcs.	24.120,00
12G	L200 x W75 x H74 cm	W210 x D42 x H16 cm 16 kg W213,5 x D88,5 x H2,5 cm 19,1kg W79 x D27 x H8 cm 11 kg	3 box 1 pcs.	23.880,00

FRAME & LEGS	TABLETOP
Army powder coated aluminium	Cloud grey linoleum
Charcoal powder coated aluminium	Dark grey linoleum
Light grey powder coated aluminium	Green linoleum
	Grey linoleum
	Water-based lacquered oak veneer

TABLE INCL. CABLE MANAGEMENT EDGE 34 CM | 4 LEGS

12 mm tabletop in MDF with linoleum or 10 mm tabletop in MDF with veneer. Incl. 40 mm cable management cover. Tabletop is placed inside the table frame. 4 legs incl. adjustable gliders. Requires assembly. STEP modules not included.

Order produced

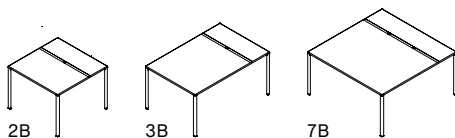

VARIANT	DIMENSION	BOX DIMENSION WEIGHT	PACKAGING	PRICE
2B	L100 x W100 x H74 cm	W160 x D42 x H16 cm 12 kg W114 x D114 x H4,5 cm 22 kg W75 x D27 x H8 cm 11 kg	3 box 1 pcs.	15.800,00
3B	L100 x W150 x H74 cm	W160 x D42 x H16 cm 14 kg W164 x D114 x H4,5 cm 26 kg W75 x D27 x H8 cm 6 kg	3 box 1 pcs.	17.400,00
7B	L150 x W150 x H74 cm	W160 x D42 x H16 cm 21 kg W164 x D89 x H9 cm 48 kg W75 x D27 x H8 cm 11 kg	3 box 1 pcs.	19.360,00

FRAME & LEGS	TABLETOP
Army powder coated aluminium	Cloud grey linoleum
Charcoal powder coated aluminium	Dark grey linoleum
Light grey powder coated aluminium	Green linoleum
	Grey linoleum
	Water-based lacquered oak veneer

TABLE INCL. PLUG & PLAY CABLE MANAGEMENT EDGE 34 CM | 4 LEGS



12 mm tabletop in MDF with linoleum or 10 mm tabletop in MDF with veneer. Incl. 80 mm plug & play cable management cover. Tabletop is placed inside the table frame. 4 legs incl. adjustable gliders. Requires assembly. STEP modules not included.

Order produced

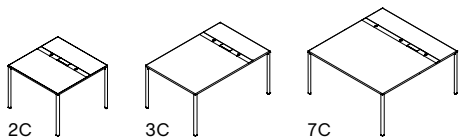

VARIANT	DIMENSION	BOX DIMENSION WEIGHT	PACKAGING	PRICE
2C	L100 x W100 x H74 cm	W160 x D42 x H16 cm 12 kg W114 x D114 x H4,5 cm 22 kg W75 x D27 x H8 cm 11 kg	3 box 1 pcs.	17.080,00
3C	L100 x W150 x H74 cm	W160 x D42 x H16 cm 14 kg W164 x D114 x H4,5 cm 26 kg W75 x D27 x H8 cm 6 kg	3 box 1 pcs.	19.320,00
7C	L150 x W150 x H74 cm	W160 x D42 x H16 cm 21 kg W164 x D89 x H9 cm 48 kg W75 x D27 x H8 cm 11 kg	3 box 1 pcs.	23.720,00

FRAME & LEGS	TABLETOP
Army powder coated aluminium	Cloud grey linoleum
Charcoal powder coated aluminium	Dark grey linoleum
Light grey powder coated aluminium	Green linoleum
	Grey linoleum
	Water-based lacquered oak veneer

TABLE INCL. CABLE MANAGEMENT EDGE 34 CM | PREPARED FOR TOP TRAY DIVIDER | 4 LEGS

12 mm tabletop in MDF with linoleum or 10 mm tabletop in MDF with veneer. Incl. 40 mm cable management cover prepared for top divider edge. Tabletop is placed inside the table frame. 4 legs incl. adjustable gliders. Requires assembly. STEP modules, top tray and single profiles not included.

Order produced

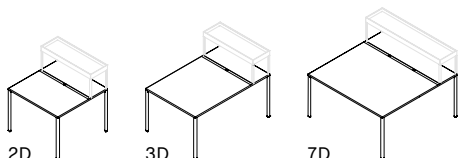

VARIANT	DIMENSION	BOX DIMENSION WEIGHT	PACKAGING	PRICE
2D	L100 x W100 x H74 cm	W160 x D42 x H16 cm 12 kg W114 x D114 x H4,5 cm 22 kg W75 x D27 x H8 cm 11 kg	3 box 1 pcs.	16.600,00
3D	L100 x W150 x H74 cm	W160 x D42 x H16 cm 14 kg W164 x D114 x H4,5 cm 26 kg W75 x D27 x H8 cm 6 kg	3 box 1 pcs.	18.120,00
7D	L150 x W150 x H74 cm	W160 x D42 x H16 cm 21 kg W164 x D89 x H9 cm 48 kg W75 x D27 x H8 cm 11 kg	3 box 1 pcs.	20.080,00

FRAME & LEGS	TABLETOP
Army powder coated aluminium	Cloud grey linoleum
Charcoal powder coated aluminium	Dark grey linoleum
Light grey powder coated aluminium	Green linoleum
	Grey linoleum
	Water-based lacquered oak veneer

TABLE INCL. PLUG & PLAY CABLE MANAGEMENT EDGE 34 CM | PREPARED FOR TOP TRAY DIVIDER | 4 LEGS



12 mm tabletop in MDF with linoleum or 10 mm tabletop in MDF with veneer. Incl. 80 mm plug & play cable management cover prepared for top divider edge. Tabletop is placed inside the table frame. 4 legs incl. adjustable gliders. Requires assembly. STEP modules, top tray and single profiles not included.

Order produced

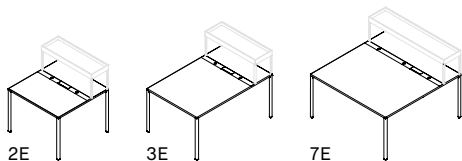

VARIANT	DIMENSION	BOX DIMENSION WEIGHT	PACKAGING	PRICE
2E	L100 x W100 x H74 cm	W160 x D42 x H16 cm 12 kg W114 x D114 x H4,5 cm 22 kg W75 x D27 x H8 cm 11 kg	3 box 1 pcs.	17.720,00
3E	L100 x W150 x H74 cm	W160 x D42 x H16 cm 14 kg W164 x D114 x H4,5 cm 26 kg W75 x D27 x H8 cm 6 kg	3 box 1 pcs.	20.040,00
7E	L150 x W150 x H74 cm	W160 x D42 x H16 cm 21 kg W164 x D89 x H9 cm 48 kg W75 x D27 x H8 cm 11 kg	3 box 1 pcs.	24.440,00

FRAME & LEGS	TABLETOP
Army powder coated aluminium	Cloud grey linoleum
Charcoal powder coated aluminium	Dark grey linoleum
Light grey powder coated aluminium	Green linoleum
	Grey linoleum
	Water-based lacquered oak veneer

TABLE INCL. CABLE MANAGEMENT | PREPARED FOR TOP TRAY DIVIDER AND TABLE SCREENS EDGE | 4 LEGS

12 mm tabletop in MDF with linoleum or 10 mm tabletop in MDF with veneer. Incl. 40 mm cable management cover and prepared for top divider and table screens edge. Tabletop is placed inside the table frame. 4 legs incl. adjustable gliders. Requires assembly. Table screens, STEP modules, top tray and single profiles not included.

Order produced

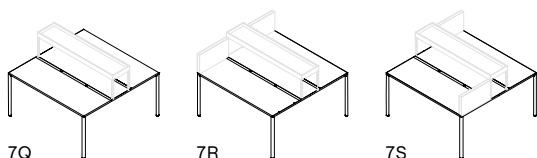

VARIANT	DIMENSION	BOX DIMENSION WEIGHT	PACKAGING	PRICE
7Q	L150 x W150 x H74 cm	W160 x D42 x H16 cm 21 kg W164 x D89 x H9 cm 48 kg W75 x D27 x H8 cm 11 kg	3 box 1 pcs.	24.440,00
7R	L150 x W150 x H74 cm	W160 x D42 x H16 cm 21 kg W164 x D89 x H9 cm 48 kg W75 x D27 x H8 cm 11 kg	3 box 1 pcs.	26.680,00
7S	L150 x W150 x H74 cm	W160 x D42 x H16 cm 21 kg W164 x D89 x H9 cm 48 kg W75 x D27 x H8 cm 11 kg	3 box 1 pcs.	26.680,00

FRAME & LEGS	TABLETOP
Army powder coated aluminium	Cloud grey linoleum
Charcoal powder coated aluminium	Dark grey linoleum
Light grey powder coated aluminium	Green linoleum
	Grey linoleum
	Water-based lacquered oak veneer

TABLE INCL. PLUG & PLAY CABLE MANAGEMENT | PREPARED FOR TOP TRAY DIVIDER AND TABLE SCREENS EDGE | 4 LEGS



12 mm tabletop in MDF with linoleum or 10 mm tabletop in MDF with veneer. Incl. 80 mm plug & play cable management cover and prepared for top divider and table screens edge. Tabletop is placed inside the table frame. 4 legs incl. adjustable gliders. Requires assembly. Table screens, STEP modules, top tray and single profiles not included.

Order produced

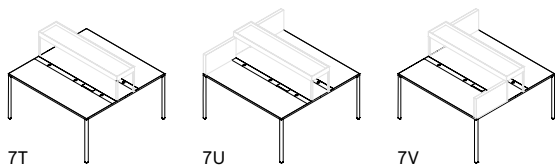

FRAME & LEGS		TABLETOP				
Army powder coated aluminium		Cloud grey linoleum				
Charcoal powder coated aluminium		Dark grey linoleum				
Light grey powder coated aluminium		Green linoleum				
		Grey linoleum				
		Water-based lacquered oak veneer				

VARIANT	DIMENSION	BOX DIMENSION WEIGHT	PACKAGING	PRICE
7T	L150 x W150 x H74 cm	W160 x D42 x H16 cm 21 kg W164 x D89 x H9 cm 48 kg W75 x D27 x H8 cm 11 kg	3 box 1 pcs.	24.440,00
7U	L150 x W150 x H74 cm	W160 x D42 x H16 cm 21 kg W164 x D89 x H9 cm 48 kg W75 x D27 x H8 cm 11 kg	3 box 1 pcs.	26.680,00
7V	L150 x W150 x H74 cm	W160 x D42 x H16 cm 21 kg W164 x D89 x H9 cm 48 kg W75 x D27 x H8 cm 11 kg	3 box 1 pcs.	26.680,00

TABLE INCL. CABLE MANAGEMENT CENTER OR PREPARED FOR TABLE SCREENS | 4 LEGS

12 mm tabletop in MDF with linoleum or 10 mm tabletop in MDF with veneer. Incl. 40 mm cable management cover or prepared for table screens. Tabletop is placed inside the table frame. 4 legs incl. adjustable gliders. Requires assembly. Table screens and STEP modules not included.

Order produced

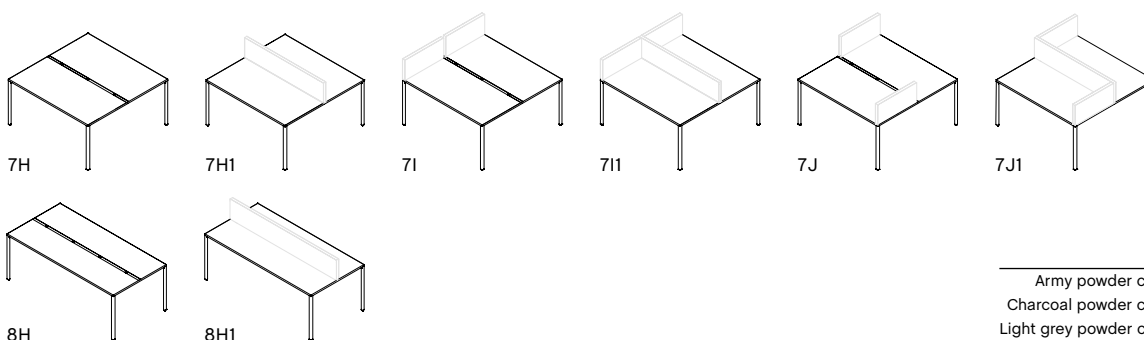

FRAME & LEGS		TABLETOP				
Army powder coated aluminium		Cloud grey linoleum				
Charcoal powder coated aluminium		Dark grey linoleum				
Light grey powder coated aluminium		Green linoleum				
		Grey linoleum				
		Water-based lacquered oak veneer				

VARIANT	DIMENSION	BOX DIMENSION WEIGHT	PACKAGING	PRICE
7H	L150 x W150 x H74 cm	W160 x D42 x H16 cm 21 kg W164 x D89 x H9 cm 48 kg W75 x D27 x H8 cm 11 kg	3 box 1 pcs.	19.360,00
7H1	L150 x W150 x H74 cm	W160 x D42 x H16 cm 21 kg W164 x D89 x H9 cm 48 kg W75 x D27 x H8 cm 11 kg	3 box 1 pcs.	19.360,00
7I	L150 x W150 x H74 cm	W160 x D42 x H16 cm 21 kg W164 x D89 x H9 cm 48 kg W75 x D27 x H8 cm 11 kg	3 box 1 pcs.	24.280,00
7I1	L150 x W150 x H74 cm	W160 x D42 x H16 cm 21 kg W164 x D89 x H9 cm 48 kg W75 x D27 x H8 cm 11 kg	3 box 1 pcs.	24.280,00
7J	L150 x W150 x H74 cm	W160 x D42 x H16 cm 21 kg W164 x D89 x H9 cm 48 kg W75 x D27 x H8 cm 11 kg	3 box 1 pcs.	24.280,00
7J1	L150 x W150 x H74 cm	W160 x D42 x H16 cm 21 kg W164 x D89 x H9 cm 48 kg W75 x D27 x H8 cm 11 kg	3 box 1 pcs.	24.280,00
8H	L200 x W100 x H74 cm	W75 x D27 x H8 cm 11 kg W202 x D42 x H14,5 cm 16 kg W214 x D114 x H4,5 cm 32 kg	3 box 1 pcs.	19.200,00
8H1	L200 x W100 x H74 cm	W75 x D27 x H8 cm 11 kg W202 x D42 x H14,5 cm 16 kg W214 x D114 x H4,5 cm 32 kg	3 box 1 pcs.	19.200,00

TABLE INCL. CABLE MANAGEMENT CENTER OR PREPARED FOR TABLE SCREENS | 4 LEGS



12 mm tabletop in MDF with linoleum or 10 mm tabletop in MDF with veneer. Incl. 40 mm cable management cover or prepared for table screens. Tabletop is placed inside the table frame. 4 legs incl. adjustable gliders. Requires assembly. Table screens and STEP modules not included.

Order produced

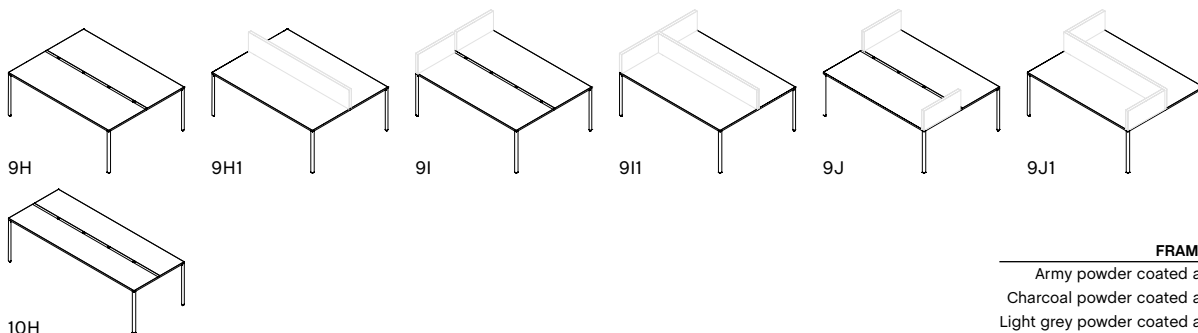

FRAME & LEGS		TABLETOP			
Army powder coated aluminium	•	•	•	•	•
Charcoal powder coated aluminium	•	•	•	•	•
Light grey powder coated aluminium	•	•	•	•	•
		Cloud grey linoleum	Dark grey linoleum	Green linoleum	Grey linoleum
					Water-based lacquered oak veneer

VARIANT	DIMENSION	BOX DIMENSION WEIGHT	PACKAGING	PRICE
9H	L200 x W150 x H74 cm	W252 x D42 x H16 cm 22 kg W214 x D89 x H9 cm 38 kg W75 x D27 x H8 cm 6 kg	3 box 1 pcs.	22.040,00
9H1	L200 x W150 x H74 cm	W252 x D42 x H16 cm 22 kg W214 x D89 x H9 cm 38 kg W75 x D27 x H8 cm 6 kg	3 box 1 pcs.	22.040,00
9I	L200 x W150 x H74 cm	W252 x D42 x H16 cm 22 kg W214 x D89 x H9 cm 38 kg W75 x D27 x H8 cm 6 kg	3 box 1 pcs.	27.560,00
9I1	L200 x W150 x H74 cm	W252 x D42 x H16 cm 22 kg W214 x D89 x H9 cm 38 kg W75 x D27 x H8 cm 6 kg	3 box 1 pcs.	27.560,00
9J	L200 x W150 x H74 cm	W252 x D42 x H16 cm 22 kg W214 x D89 x H9 cm 38 kg W75 x D27 x H8 cm 6 kg	3 box 1 pcs.	27.560,00
9J1	L200 x W150 x H74 cm	W252 x D42 x H16 cm 22 kg W214 x D89 x H9 cm 38 kg W75 x D27 x H8 cm 6 kg	3 box 1 pcs.	27.560,00
10H	L250 x W100 x H74 cm	W252 x D42 x H16 cm 20 kg W264 x D114 x H4,5 cm 38 kg W75 x D27 x H8 cm 6 kg	3 box 1 pcs.	25.080,00

TABLE INCL. PLUG & PLAY CABLE MANAGEMENT CENTER OR PREPARED FOR TABLE SCREENS | 4 LEGS

12 mm tabletop in MDF with linoleum or 10 mm tabletop in MDF with veneer. Incl. 80 mm plug & play cable management cover or prepared for table screens. Tabletop is placed inside the table frame. 4 legs incl. adjustable gliders. Requires assembly. Table screens and STEP modules not included.

Order produced

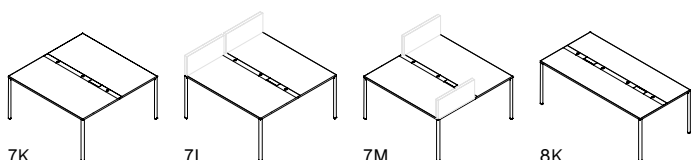

FRAME & LEGS		TABLETOP			
Army powder coated aluminium	•	•	•	•	•
Charcoal powder coated aluminium	•	•	•	•	•
Light grey powder coated aluminium	•	•	•	•	•
		Cloud grey linoleum	Dark grey linoleum	Green linoleum	Grey linoleum
					Water-based lacquered oak veneer

VARIANT	DIMENSION	BOX DIMENSION WEIGHT	PACKAGING	PRICE
7K	L150 x W150 x H74 cm	W252 x D42 x H16 cm 22 kg W214 x D89 x H9 cm 38 kg W75 x D27 x H8 cm 6 kg	3 box 1 pcs.	23.720,00
7L	L150 x W150 x H74 cm	W252 x D42 x H16 cm 22 kg W214 x D89 x H9 cm 38 kg W75 x D27 x H8 cm 6 kg	3 box 1 pcs.	25.720,00
7M	L150 x W150 x H74 cm	W252 x D42 x H16 cm 22 kg W214 x D89 x H9 cm 38 kg W75 x D27 x H8 cm 6 kg	3 box 1 pcs.	25.720,00
8K	L250 x W100 x H74 cm	W252 x D42 x H16 cm 20 kg W264 x D114 x H4,5 cm 38 kg W75 x D27 x H8 cm 6 kg	3 box 1 pcs.	24.200,00

TABLE INCL. PLUG & PLAY CABLE MANAGEMENT CENTER OR PREPARED FOR TABLE SCREENS | 4 LEGS



12 mm tabletop in MDF with linoleum or 10 mm tabletop in MDF with veneer. Incl. 80 mm plug & play cable management cover or prepared for table screens. Tabletop is placed inside the table frame. 4 legs incl. adjustable gliders. Requires assembly. Table screens and STEP modules not included.

Order produced

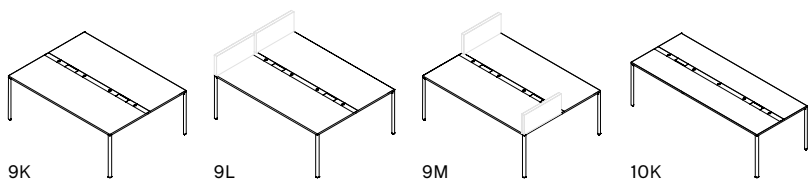

FRAME & LEGS		TABLETOP			
Army powder coated aluminium		Cloud grey linoleum			
Charcoal powder coated aluminium		Dark grey linoleum			
Light grey powder coated aluminium		Green linoleum			
		Grey linoleum			
		Water-based lacquered oak veneer			

VARIANT	DIMENSION	BOX DIMENSION WEIGHT	PACKAGING	PRICE
9K	L200 x W150 x H74 cm	W202 x D42 x H14,5 cm 16 kg W75 x D27 x H8 cm 6 kg W214 x D114 x H4,5 cm 32 kg	3 box 1 pcs.	26.920,00
9L	L200 x W150 x H74 cm	W202 x D42 x H14,5 cm 16 kg W75 x D27 x H8 cm 6 kg W214 x D114 x H4,5 cm 32 kg	3 box 1 pcs.	29.000,00
9M	L200 x W150 x H74 cm	W160 x D42 x H16 cm 21 kg W164 x D89 x H9 cm 48 kg W75 x D27 x H8 cm 11 kg	3 box 1 pcs.	29.000,00
10K	L150 x W150 x H74 cm	W202 x D42 x H14,5 cm 16 kg W75 x D27 x H8 cm 6 kg W214 x D114 x H4,5 cm 32 kg	3 box 1 pcs.	30.760,00

TABLE INCL. DOUBLE PLUG & PLAY CABLE MANAGEMENT CENTER IN COMBINATION WITH TABLE SCREENS | 4 LEGS

12 mm tabletop in MDF with linoleum or 10 mm tabletop in MDF with veneer. Incl. 80 mm plug & play cable management cover and prepared for table screens. Tabletop is placed inside the table frame. 4 legs incl. adjustable gliders. Requires assembly. Table screens and STEP modules not included.

Order produced

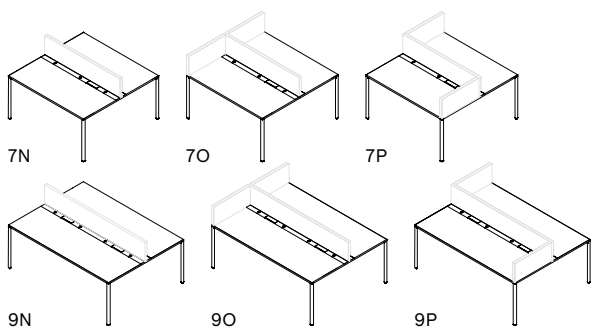

FRAME & LEGS		TABLETOP			
Army powder coated aluminium		Cloud grey linoleum			
Charcoal powder coated aluminium		Dark grey linoleum			
Light grey powder coated aluminium		Green linoleum			
		Grey linoleum			
		Water-based lacquered oak veneer			

VARIANT	DIMENSION	BOX DIMENSION WEIGHT	PACKAGING	PRICE
7N	L150 x W150 x H74 cm	W160 x D42 x H16 cm 21 kg W164 x D89 x H9 cm 48 kg W75 x D27 x H8 cm 11 kg	3 box 1 pcs.	25.000,00
7O	L150 x W150 x H74 cm	W160 x D42 x H16 cm 21 kg W164 x D89 x H9 cm 48 kg W75 x D27 x H8 cm 11 kg	3 box 1 pcs.	27.080,00
7P	L150 x W150 x H74 cm	W160 x D42 x H16 cm 21 kg W164 x D89 x H9 cm 48 kg W75 x D27 x H8 cm 11 kg	3 box 1 pcs.	27.080,00
9N	L150 x W150 x H74 cm	W202 x D42 x H14,5 cm 16 kg W75 x D27 x H8 cm 6 kg W214 x D114 x H4,5 cm 32 kg	3 box 1 pcs.	27.800,00
9O	L200 x W150 x H74 cm	W252 x D42 x H16 cm 22 kg W214 x D89 x H9 cm 38 kg W75 x D27 x H8 cm 6 kg	3 box 1 pcs.	29.880,00
9P	L200 x W150 x H74 cm	W252 x D42 x H16 cm 22 kg W214 x D89 x H9 cm 38 kg W75 x D27 x H8 cm 6 kg	3 box 1 pcs.	29.880,00

TABLE SCREEN

Wood structure with MDF panels, 3 mm foam layer upholstered with textile. Incl. integrated brackets for mounting on the frame. Table screen edge can be mounted on tables in width 150 cm. Table screen edge 58 to be used in combination with top tray dividers.

Order produced



VARIANT	DIMENSION	BOX DIMENSION WEIGHT	PACKAGING		PRICE
Edge 58	W5 x D58 x H75 cm	W5 x D58 x H33 cm 3,6 kg	1 box 1 pcs.	Remix	4.080,00
				Surface by HAY	3.640,00
				Steelcut	4.480,00
				Steelcut Trio	4.480,00
				Canvas	4.600,00



VARIANT	DIMENSION	BOX DIMENSION WEIGHT	PACKAGING		PRICE
Edge 73	W73 x D4 x H33 cm	W73 x D4 x H33 cm 4,3 kg	1 box 1 pcs.	Remix	4.080,00
				Surface by HAY	3.640,00
				Steelcut	4.480,00
				Steelcut Trio	4.480,00
				Canvas	4.600,00

TABLE SCREEN

Wood structure with MDF panels, 3 mm foam layer upholstered with textile. Incl. integrated brackets for mounting into the frame. Table screen middle is mounted on the support bar.

Order produced



VARIANT	DIMENSION	BOX DIMENSION WEIGHT	PACKAGING		PRICE
Middle L100	W100 x D4 x H33 cm	W100 x D4 x H33 cm 5,5 kg	1 box 1 pcs.	Remix	4.080,00
				Surface by HAY	4.080,00
				Steelcut	4.480,00
				Steelcut Trio	4.480,00
				Canvas	4.600,00



VARIANT	DIMENSION	BOX DIMENSION WEIGHT	PACKAGING		PRICE
Middle L150	W150 x D4 x H33 cm	W150 x D4 x H33 cm 7,2 kg	1 box 1 pcs.	Remix	5.520,00
				Surface by HAY	5.520,00
				Steelcut	6.080,00
				Steelcut Trio	6.080,00
				Canvas	6.200,00



VARIANT	DIMENSION	BOX DIMENSION WEIGHT	PACKAGING		PRICE
Middle L200	W200 x D4 x H33 cm	W200 x D4 x H33 cm 10,8 kg	1 box 1 pcs.	Remix	7.640,00
				Surface by HAY	7.640,00
				Steelcut	8.160,00
				Steelcut Trio	8.160,00
				Canvas	8.320,00

TABLE LEG | SINGLE

Powder coated extruded aluminium. Incl. adjustable gliders.

Stock item

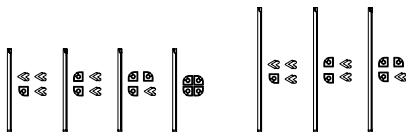

MATERIAL	COLOUR		
	Army	Charcoal	Light grey
Powder coated extruded aluminium	•	•	•

VARIANT	DIMENSION	BOX DIMENSION WEIGHT	PACKAGING	PRICE
H74 Single Set of 1	W3,4 x D3,4 x H74 cm	W79 x D27 x H8 cm 5,65 kg	1 box 1 pcs.	2.240,00
H74 Single Set of 2	W3,4 x D3,4 x H74 cm	W79 x D27 x H8 cm 6,85 kg	1 box 1 pcs.	3.080,00
H74 Single Set of 3	W3,4 x D3,4 x H74 cm	W79 x D27 x H8 cm 8,05 kg	1 box 1 pcs.	3.960,00
H74 Single Set of 4	W3,4 x D3,4 x H74 cm	W79 x D27 x H8 cm 9,25 kg	1 box 1 pcs.	4.760,00
H110 Single Set of 1	W3,4 x D3,4 x H110 cm	W115 x D27 x H8 cm 6,25 kg	1 box 1 pcs.	2.360,00
H110 Single Set of 2	W3,4 x D3,4 x H110 cm	W115 x D27 x H8 cm 7,85 kg	1 box 1 pcs.	3.360,00
H110 Single Set of 3	W3,4 x D3,4 x H110 cm	W115 x D27 x H8 cm 8,85 kg	1 box 1 pcs.	4.360,00

TABLE LEG | DOUBLE

Powder coated extruded aluminium. Incl. adjustable gliders.

Stock item

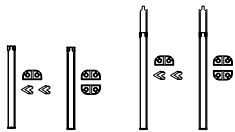

MATERIAL	COLOUR		
	Army	Charcoal	Light grey
Powder coated extruded aluminium	•	•	•

VARIANT	DIMENSION	BOX DIMENSION WEIGHT	PACKAGING	PRICE
H74 Double Set of 1	W6,8 x D3,4 x H74 cm	W79 x D27 x H8 cm 6,55 kg	1 box 1 pcs.	3.080,00
H74 Double Set of 2	W6,8 x D3,4 x H74 cm	W79 x D27 x H8 cm 8,05 kg	1 box 1 pcs.	4.760,00
H110 Double Set of 1	W6,8 x D3,4 x H110 cm	W115 x D27 x H8 cm 7,85 kg	1 box 1 pcs.	3.360,00
H110 Double Set of 2	W6,8 x D3,4 x H110 cm	W115 x D27 x H8 cm 8,45 kg	1 box 1 pcs.	5.400,00

TABLE CONNECTOR

Powder coated steel

Stock item

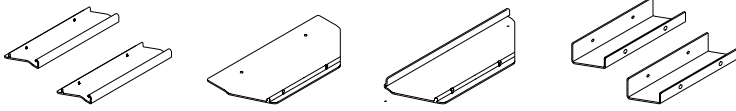

VARIANT	BOX DIMENSION WEIGHT	PACKAGING	PRICE	MATERIAL	
				COLOUR	
Front Set of 2	W26,5 x D15 x H7,5 cm 0,5 kg	1 box 1 pcs.	284,00	Powder coated steel	Army Charcoal Light grey
End shelf	W28 x D13,5 x H1,5 cm 0,25 kg	1 box 1 pcs.	284,00		
End tray	W28 x D10 x H1,5 cm 0,25 kg	1 box 1 pcs.	284,00		
Wall Set of 2	W26 x D15,5 x H7,5 cm 0,7 kg	1 box 1 pcs.	712,00		

CABLE CLIP | SET OF 2

Black PP plastic. To be mounted in the frame channel underneath the table or in a support bar to hold cables. Max. 3 standard cables.

Stock item

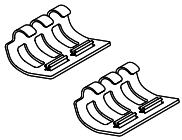

VARIANT	BOX DIMENSION WEIGHT	PACKAGING	PRICE	MATERIAL	
				COLOUR	
Cable clip Set of 2	W6,5 x D4,5 x H3,5 cm 0,05 kg	1 box 1 pcs.	40,00	PP Plastic	Black

CABLE GUIDE

ABS plastic. Recommended for maximum 3 standard cables.

Stock item

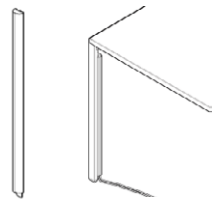

VARIANT	BOX DIMENSION WEIGHT	PACKAGING	PRICE	MATERIAL	
				COLOUR	
For table leg H74	W3,3 x D2,2 x H64 cm 0,05 kg	1 box 1 pcs.	40,00	ABS Plastic	Army Charcoal Light grey

HIGH TABLE | H90 CM

12 mm tabletop in MDF with linoleum or 10 mm tabletop in MDF with veneer. Tabletop is placed inside the table frame. 4 legs in two heights incl. adjustable gliders. STEP modules not included. Requires assembly.



Order produced

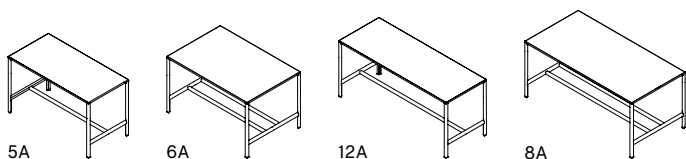

5A

6A

12A

8A

FRAME & LEGS	TABLETOP			
	Cloud grey linoleum	Dark grey linoleum	Green linoleum	Grey linoleum
Army powder coated aluminium	•	•	•	•
Charcoal powder coated aluminium	•	•	•	•
Light grey powder coated aluminium	•	•	•	•

Water-based lacquered oak veneer

VARIANT	DIMENSION	BOX DIMENSION WEIGHT	PACKAGING	PRICE
5A	L150 x W75 x H90 cm	W163 x D88,5 x H2,5 cm 14,6 kg W160 x D85 x H8 cm 12 kg W115 x D27 x H8 cm 16 kg W163 x D42 x H16 cm 9 kg	4 box 1 pcs.	18.000,00
6A	L150 x W100 x H90 cm	W213,5 x D88,5 x H2,5 cm 19,1 kg W210 x D85 x H8 cm 15 kg W115 x D27 x H8 cm 16 kg W210 x D42 x H16 cm 15 kg	4 box 1 pcs.	17.880,00
12A	L200 x W75 x H90 cm	W163 x D113,5 x H2,5 cm 19,3 kg W160 x D110 x H8 cm 13 kg W115 x D27 x H8 cm 16 kg W163 x D42 x H16 cm 14 kg	4 box 1 pcs.	19.880,00
8A	L200 x W100 x H90 cm	W213,5 x D113,5 x H2,5 cm 25,6 kg W210 x D110 x H8 cm 16 kg W115 x D27 x H8 cm 16 kg W213 x D42 x H16 cm 18 kg	4 box 1 pcs.	20.120,00

HIGH TABLE | H105 CM

12 mm tabletop in MDF with linoleum or 10 mm tabletop in MDF with veneer. Tabletop is placed inside the table frame. 4 legs in two heights incl. adjustable gliders. STEP modules not included. Requires assembly.

Order produced

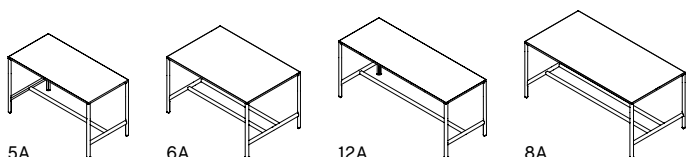

5A

6A

12A

8A

FRAME & LEGS	TABLETOP			
	Cloud grey linoleum	Dark grey linoleum	Green linoleum	Grey linoleum
Army powder coated aluminium	•	•	•	•
Charcoal powder coated aluminium	•	•	•	•
Light grey powder coated aluminium	•	•	•	•

Water-based lacquered oak veneer

VARIANT	DIMENSION	BOX DIMENSION WEIGHT	PACKAGING	PRICE
5A	L150 x W75 x H105 cm	W163 x D88,5 x H2,5 cm 14,6 kg W160 x D85 x H8 cm 12 kg W115 x D27 x H8 cm 17 kg W213 x D42 x H16 cm 9 kg	4 box 1 pcs.	18.120,00
12A	L150 x W100 x H105 cm	W213,5 x D88,5 x H2,5 cm 19,1 kg W210 x D85 x H8 cm 15 kg W115 x D27 x H8 cm 16 kg W210 x D42 x H16 cm 16 kg	4 box 1 pcs.	18.000,00
6A	L200 x W75 x H105 cm	W163 x D113,5 x H2,5 cm 19,3 kg W160 x D110 x H8 cm 13 kg W115 x D27 x H8 cm 16 kg W163 x D42 x H16 cm 19,3 kg	4 box 1 pcs.	20.000,00
8A	L200 x W100 x H105 cm	W213,5 x D113,5 x H2,5 cm 25,6 kg W210 x D110 x H8 cm 16 kg W115 x D27 x H8 cm 16 kg W213 x D42 x H16 cm 18 kg	4 box 1 pcs.	20.240,00

CABLE TRAY FOR L35

Powder coated steel.

Stock item

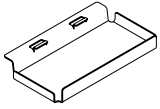

MATERIAL	COLOUR
Powder coated steel	Charcoal

VARIANT	DIMENSION	BOX DIMENSION WEIGHT	PACKAGING	PRICE
L35	W35 x D21 x H4,2 cm	W38 x D23 x H6 cm 1 kg	1 box 1 pcs.	424,00

CABLE TRAY FOR STEP L35

Powder coated steel. Prepared for STEP Module.

Stock item

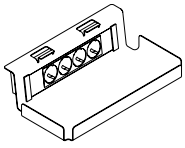

MATERIAL	COLOUR
Powder coated steel	Army Charcoal Light grey

VARIANT	DIMENSION	BOX DIMENSION WEIGHT	PACKAGING	PRICE
for STEP L35	W35 x D21 x H7 cm	W38 x D23 x H9 cm 1,2 kg	1 box 1 pcs.	568,00

STEP MODULES FOR CABLE MANAGEMENT

STEP BASE in plastic and STEP ALU in aluminium. NO STEP module power strip profile with 3 or 4 outlets. Customer outlets CAT6 or HDMI are sold separately. The custom module fits two customer outlets. The STEP Module fits into NO support bar or cable tray prepared for STEP module.

Stock item

MATERIAL	COLOUR
	Charcoal
Powder coated steel	•

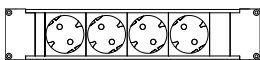
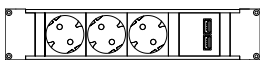
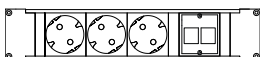
CEE/GE++ PLUG TYPE F	VARIANT	DIMENSION	BOX DIMENSION WEIGHT	PACKAGING	PRICE
	4 OUTLETS	W30 x D5,5 x H4,5 cm	W30 x D5,5 x H4,5 cm 0,39 kg	1 box 1 pcs.	656,00
	3 OUTLETS + 1 DOUBLE USB	W30 x D5,5 x H4,5 cm	W32 x D7,5 x H6,5 cm 0,35 kg	1 box 1 pcs.	1.000,00
	3 OUTLETS + 1 CUSTOMER MODULE W/2 OUTLET	W40x D7 x H7,5 cm	W2,1 x D2,1 x H0,2 cm 0,1 kg	1 box 1 pcs.	728,00

PLUG TYPE F (CEE GE++)

AD, AF, AL, AM, AN (CW, SX, BO), AS, AT, AW, AZ, BA, BG, BT, BY, CV, DE, DK, DZ, EE, EG, ES, ET, FI, FO, GE, GL, GN, GR, HR, HU, ID, IS, IR, IT, JO, KG, KP, KR, KZ, LA, LR, LT, LU, LV, LY, MC, MD, ME, MF, MK, MM, MO, MZ, NC, NE, NL, NO, PT, RO, RS, RU, SE, SI, SM, SR, ST, TD, TH, TJ, TL, TM, TR, UA, UY, VN

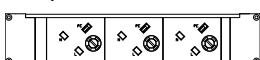
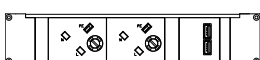
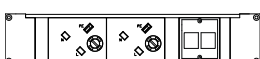
UK++ PLUG TYPE G	VARIANT	DIMENSION	BOX DIMENSION WEIGHT	PACKAGING	PRICE
	3 OUTLETS	W30 x D5,5 x H4,5 cm	W30 x D5,5 x H4,5 cm 0,35 kg	1 box 1 pcs.	656,00
	2 OUTLETS + 1 DOUBLE USB	W30 x D5,5 x H4,5 cm	W30 x D5,5 x H4,5 cm 0,35 kg	1 box 1 pcs.	1.120,00
	2 OUTLETS + 1 CUSTOMER MODULE W/2 OUTLET	W40x D7 x H7,5 cm	W2,1 x D2,1 x H0,2 cm 0,1 kg	1 box 1 pcs.	728,00

PLUG TYPE G (UK++)

AE, BD, BH, BN, BT, BW, BZ, CY, DM, FK, GB, GD, GH, GI, GM, GY, HK, IE, IM, IQ, JO, KE, KH, KN, KW, LB, LC, LK, MM, MO, MT, MU, MV, MW, MY, NG, OM, PK, QA, SA, SB, SC, SG, SL, TZ, UG, VC, VU, YE, ZM, ZW

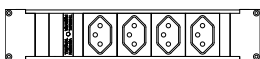
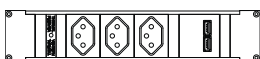
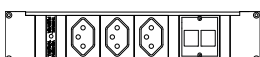
CH++ PLUG TYPE J	VARIANT	DIMENSION	BOX DIMENSION WEIGHT	PACKAGING	PRICE
	4 OUTLETS	W30 x D5,5 x H4,5 cm	W32 x D7,5 x H6,5 cm 0,35 kg	1 box 1 pcs.	632,00
	3 OUTLETS + 1 DOUBLE USB	W30 x D5,5 x H4,5 cm	W32 x D7,5 x H6,5 cm 0,35 kg	1 box 1 pcs.	1.000,00
	3 OUTLETS + 1 CUSTOMER MODULE W/2 OUTLET	W40x D7 x H7,5 cm	W2,1 x D2,1 x H0,2 cm 0,1 kg	1 box 1 pcs.	728,00

PLUG TYPE J (CH++)

CH, JO, LI, MG, MV, RW

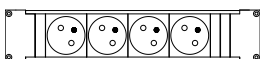
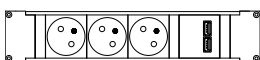
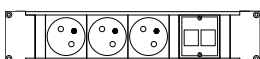
FR++ PLUG TYPE E	VARIANT	DIMENSION	BOX DIMENSION WEIGHT	PACKAGING	PRICE
	4 OUTLETS	W30 x D5,5 x H4,5 cm	W30 x D5,5 x H4,5 cm 0,35 kg	1 box 1 pcs.	656,00
	3 OUTLETS + 1 DOUBLE USB	W30 x D5,5 x H4,5 cm	W32 x D7,5 x H6,5 cm 0,35 kg	1 box 1 pcs.	1.000,00
	3 OUTLETS + 1 CUSTOMER MODULE W/2 OUTLET	W40x D7 x H7,5 cm	W2,1 x D2,1 x H0,2 cm 0,1 kg	1 box 1 pcs.	728,00

PLUG TYPE E (FR++)

BE, BF, BI, BJ, CD, CF, CG, CI, CM, CZ, DK, DJ, ET, FO, FR, GF, GL, GP, GQ, KM, LA, LR, MA, MC, MG, ML, MN, MQ, NE, PL, RE, SK, SN, SY, TD, TL, TN, VC

STEP MODULES FOR CABLE MANAGEMENT

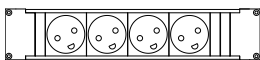
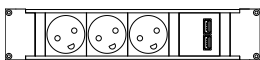
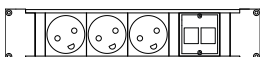

STEP BASE in plastic and STEP ALU in aluminium. NO STEP module power strip profile with 3 or 4 outlets. Customer outlets CAT6 or HDMI are sold separately. The custom module fits two customer outlets. The STEP Module fits into NO support bar or cable tray prepared for STEP module.

Stock item

DK++ PLUG TYPE K	VARIANT	DIMENSION	BOX DIMENSION WEIGHT	PACKAGING	PRICE
	4 OUTLETS	W30 x D5,5 x H4,5 cm	W30 x D5,5 x H4,5 cm 0,35 kg	1 box 1 pcs.	656,00
	3 OUTLETS + 1 DOUBLE USB	W30 x D5,5 x H4,5 cm	W32 x D7,5 x H6,5 cm 0,35 kg	1 box 1 pcs.	1.000,00
	3 OUTLETS + 1 CUSTOMER MODULE W/2 OUTLET	W40x D7 x H7,5 cm	W2,1 x D2,1 x H0,2 cm 0,1 kg	1 box 1 pcs.	728,00

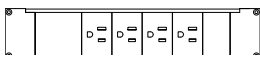
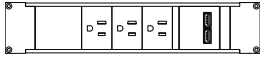

PLUG TYPE K (DK++)

BD, DK, FO, GL, GN, MG, MV, SN, VC

US++ PLUG TYPE A	VARIANT	DIMENSION	BOX DIMENSION WEIGHT	PACKAGING	PRICE
	4 OUTLETS	W30 x D5,5 x H4,5 cm	W32 x D7,5 x H6,5 cm 0,35 kg	1 box 1 pcs.	632,00
	3 OUTLETS + 1 DOUBLE USB	W30 x D5,5 x H4,5 cm	W32 x D7,5 x H6,5 cm 0,35 kg	1 box 1 pcs.	1.000,00
	3 OUTLETS + 1 CUSTOMER MODULE W/2 OUTLET	W40x D7 x H7,5 cm	W2,1 x D2,1 x H0,2 cm 0,1 kg	1 box 1 pcs.	728,00

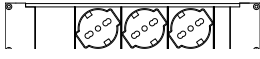

PLUG TYPE A (US++)

AG, AI, AN (CW, SX, BQ), AS, AW, BB, BM, BO, BS, BZ, CA, CN, CO, CR, CU, DO, EC, FM, GT, GU, GY, HN, HT, JM, JP, KH, KN, KP, KY, LA, LB, LR, SV, MS, MV, MX, MY, NE, NI, PA, PE, PH, PR, PW, TC, TH, TT, TW, US, VC, VE, VG, VI, VN, YE

IT++ PLUG TYPE L	VARIANT	DIMENSION	BOX DIMENSION WEIGHT	PACKAGING	PRICE
	3 OUTLETS	W30 x D5,5 x H4,5 cm	W30 x D5,5 x H4,5 cm 0,35 kg	1 box 1 pcs.	656,00
	2 OUTLETS + 1 DOUBLE USB	W30 x D5,5 x H4,5 cm	W32 x D7,5 x H6,5 cm 0,35 kg	1 box 1 pcs.	1.000,00
	2 OUTLETS + 1 CUSTOMER MODULE W/2 OUTLET	W40x D7 x H7,5 cm	W2,1 x D2,1 x H0,2 cm 0,1 kg	1 box 1 pcs.	728,00

PLUG TYPE L (IT++)

CL, ER, ET, IT, MV, SM, SY, UY

ALL COUNTRIES	VARIANT	DIMENSION	BOX DIMENSION WEIGHT	PACKAGING	PRICE
	CAT6 OUTLET	W0,1 x D0,1 x H0,1 cm	W2,1 x D2,1 x H0,2 cm 0,1 kg	1 box 1 pcs.	568,00
	HDMI OUTLET	W0,1 x D0,1 x H0,1 cm	W2,1 x D2,1 x H0,2 cm 0,1 kg	1 box 1 pcs.	568,00

STEP MODULE EXTENSION CABLE

L200 cm

Stock item

EXTENSION CABLE

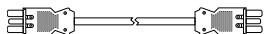

VARIANT

EXTENSION CABLE 2 M

DIMENSION

W5 x D0,1 x H200 cm

BOX DIMENSION | WEIGHT

W27 x D7 x H7 cm | 0,5 kg

PACKAGING

1 box | 1 pcs.

PRICE

284,00

STEP MODULES SUPPLY CABLES

L500 cm

Stock item

SUPPLY CABLE

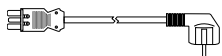

VARIANT

PLUG TYPE E (FR++) / TYPE F (CEE / GE++)

DIMENSION

W5 x D0,1 x H500 cm

BOX DIMENSION | WEIGHT

W27 x D7 x H7 cm | 0,5 kg

PACKAGING

1 box | 1 pcs.

PRICE

388,00

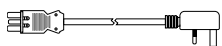

PLUG TYPE G (UK++)

W5 x D0,1 x H500 cm

W27 x D7 x H7 cm | 0,5 kg

1 box | 1 pcs.

388,00

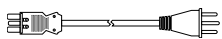

PLUG TYPE J (CH++)

W5 x D0,1 x H500 cm

W27 x D7 x H7 cm | 0,5 kg

1 box | 1 pcs.

388,00

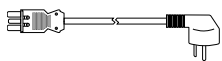

PLUG TYPE K (DK++)

W5 x D0,1 x H500 cm

W27 x D7 x H7 cm | 0,5 kg

1 box | 1 pcs.

388,00

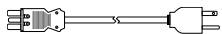

PLUG TYPE A (US++)

W5 x D0,1 x H500 cm

W27 x D7 x H7 cm | 0,5 kg

1 box | 1 pcs.

1.280,00

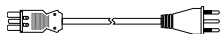

PLUG TYPE L (IT++)

W5 x D0,1 x H500 cm

W27 x D7 x H7 cm | 0,5 kg

1 box | 1 pcs.

388,00

CABLE COVER W/ PEN HOLDER

Powder coated aluminium

Stock item

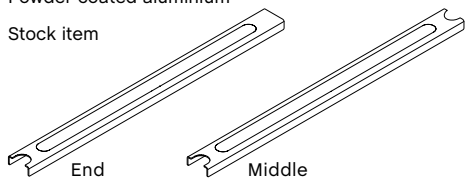

MATERIAL	COLOUR		
	Army	Charcoal	Light grey
Powder coated aluminium	•	•	•

VARIANT	DIMENSION	BOX DIMENSION WEIGHT	PACKAGING	PRICE
For standard cabled. End 50	W50 x D4 x H1 cm	W52 x D42 x H3 cm 0,4 kg	1 box 1 pcs.	120,00
For standard cabled. Middle 50	W50 x D4 x H1 cm	W52 x D42 x H3 cm 0,4 kg	1 box 1 pcs.	120,00

CABLE COVER

Powder coated aluminium

Stock item

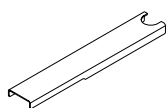

MATERIAL	COLOUR		
	Army	Charcoal	Light grey
Powder coated aluminium	•	•	•

VARIANT	DIMENSION	BOX DIMENSION WEIGHT	PACKAGING	PRICE
For standard cabled. End 25	W25 x D4 x H1 cm	W27 x D42 x H3 cm 0,1 kg	1 box 1 pcs.	200,00

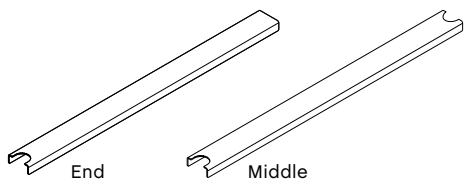

VARIANT	DIMENSION	BOX DIMENSION WEIGHT	PACKAGING	PRICE
For standard cabled. End 50	W50 x D4 x H1 cm	W52 x D42 x H3 cm 0,6 kg	1 box 1 pcs.	200,00
For standard cabled. Middle 50	W50 x D4 x H1 cm	W52 x D42 x H3 cm 0,6 kg	1 box 1 pcs.	200,00

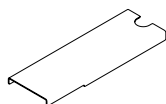

VARIANT	DIMENSION	BOX DIMENSION WEIGHT	PACKAGING	PRICE
For Plug & Play and Double P&P cabled. End 25	W25 x D8 x H1 cm	W27 x D82 x H3 cm 0,79 kg	1 box 1 pcs.	264,00

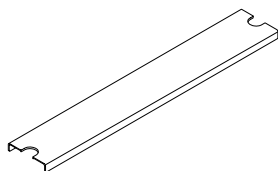

VARIANT	DIMENSION	BOX DIMENSION WEIGHT	PACKAGING	PRICE
For Plug & Play and Double P&P cabled. Middle 50	W50 x D8 x H1 cm	W52 x D82 x H3 cm 1 kg	1 box 1 pcs.	328,00

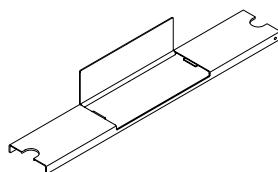

VARIANT	DIMENSION	BOX DIMENSION WEIGHT	PACKAGING	PRICE
For Plug & Play and Double P&P cabled. Flip 50	W50 x D8 x H1 cm	W52 x D82 x H3 cm 0,4 kg	1 box 1 pcs.	568,00

COMBINATION 101



ITEM LIST

- 1 x NO Shelf Bottom 100 cm
- 1 x NO Tray Top 100 cm
- 1 x NO Single Profile | Set of 4
- 1 x NO Wheels 34 mm Black | Set of 4

Stock item

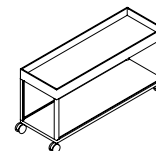

MATERIAL	COLOUR			
	Army	Charcoal	Light grey	Red
Powder coated aluminium	•	•	•	•

VARIANT	DIMENSION	BOX DIMENSION WEIGHT	PACKAGING	PRICE
Combination 101	W100 x D34 x H49,9 cm	W18,5 x D16 x H4,5 cm 0,4 kg W34,5 x D5,5 x H5,5 cm 0,9 kg W105 x D39,5 x H16 cm 5,9 kg W105 x D39,5 x H10,5 cm 6,2 kg	1 box 1 pcs.	4.816,00

COMBINATION 102

ITEM LIST

- 1 x NO Tray Top 150 cm
- 1 x NO Shelf Bottom 150 cm
- 1 x NO Single Profile | Set of 4
- 1 x NO Wheels 34 mm Black | Set of 4

Stock item

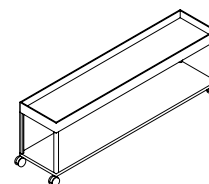

MATERIAL	COLOUR			
	Army	Charcoal	Light grey	Red
Powder coated aluminium	•	•	•	•

VARIANT	DIMENSION	BOX DIMENSION WEIGHT	PACKAGING	PRICE
Combination 102	W150 x D34 x H49,9 cm	W18,5 x D16 x H4,5 cm 0,4 kg W34,5 x D5,5 x H5,5 cm 0,9 kg W155 x D39,5 x H16 cm 8,3 kg W155 x D39,5 x H10,5 cm 9,0 kg	1 box 1 pcs.	6.496,00

COMBINATION 103

ITEM LIST

- 2 x NO Shelf Bottom 100 cm
- 2 x NO Tray Top 100 cm
- 1 x NO Single Profile | Set of 4
- 1 x NO Double Profile | Set of 2
- 2 x NO Wheels 34 mm Black | Set of 4

Stock item

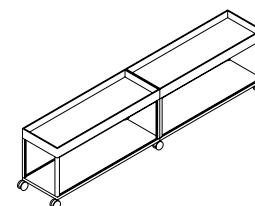

MATERIAL	COLOUR			
	Army	Charcoal	Light grey	Red
Powder coated aluminium	•	•	•	•

VARIANT	DIMENSION	BOX DIMENSION WEIGHT	PACKAGING	PRICE
Combination 103	W200 x D34 x H49,9 cm	2 pcs, W18,5 x D16 x H4,5 cm 0,4 kg W34,5 x D5,5 x H5,5 cm 0,9 kg W34,5 x D5,5 x H5,5 cm 0,9 kg 2 pcs, W105 x D39,5 x H16 cm 5,9 kg 2 pcs, W105 x D39,5 x H10,5 cm 6,2 kg	1 box 1 pcs.	9.632,00

BENCH COMBINATION L100



ITEM LIST

- 1 x NO Shelf Top 100 cm
- 1 x NO Shelf Bottom 100 cm
- 1 x NO Single Profile | Set of 4
- 1 x NO Benchtop 100 cm

Order produced

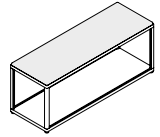

MATERIAL	COLOUR			
	Army	Charcoal	Light grey	Red
Powder coated aluminium	•	•	•	•

VARIANT	DIMENSION	BOX DIMENSION WEIGHT	PACKAGING	DESCRIPTION	PRICE
Bench Combination L100 Max. load 30 kg	W100 x D34 x H38,7 cm	W105 x D36 x H5 cm 3,0 kg W34,5 x D5,5 x H5,5 cm 0,9 kg W105 x D39,5 x H10,5 cm 6,4 kg W105 x D39,5 x H10,5 cm 6,2 kg	1 box 1 pcs.	Remix Steelcut Steelcut Trio Canvas Sierra Black leather Sense Cognac leather	6.392,00 6.512,00 6.512,00 6.632,00 7.152,00 7.952,00

BENCH COMBINATION L150

ITEM LIST

- 1 x NO Shelf Top 150 cm
- 1 x NO Shelf Bottom 150 cm
- 1 x NO Single Profile | Set of 4
- 1 x NO Benchtop 150 cm

Order produced

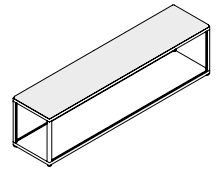

MATERIAL	COLOUR			
	Army	Charcoal	Light grey	Red
Powder coated aluminium	•	•	•	•

VARIANT	DIMENSION	BOX DIMENSION WEIGHT	PACKAGING	DESCRIPTION	PRICE
Bench Combination L150 Max. load 30 kg	W150 x D34 x H38,7 cm	W155 x D36 x H5 cm 3,5 kg W34,5 x D5,5 x H5,5 cm 0,9 kg W155 x D39,5 x H10,5 cm 9,1 kg W155 x D39,5 x H10,5 cm 9,0 kg	1 box 1 pcs.	Remix Steelcut Steelcut Trio Canvas Sierra Black leather Sense Cognac leather	8.992,00 9.192,00 9.192,00 9.392,00 10.232,00 11.472,00

COMBINATION 201

ITEM LIST

- 1 x NO Shelf Top 100 cm
- 1 x NO Shelf Middle 100 cm
- 1 x NO Shelf Bottom 100 cm
- 1 x NO Single Profile | Set of 4
- 2 x NO Steel shelf 100 cm | Incl. pin 4 pcs. for adjustable side panels | Powder coated steel
- 2 x NO Steel side panel double height 34 cm for adjustable shelf | Powder coated steel
- 1 x NO Steel wall back panel double height 100 cm | Powder coated steel
- 1 x NO Single Profile for double height | Set of 4
- 1 x NO Steel sliding door double height 100 cm | Incl. handle, powder coated steel

Please remember to specify wall- or floor safety brackets when ordering this combination.

Order produced

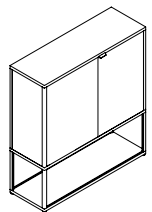

MATERIAL	COLOUR			
	Army	Charcoal	Light grey	Red
Powder coated aluminium	•	•	•	•

VARIANT	DIMENSION	BOX DIMENSION WEIGHT	PACKAGING	PRICE
Combination 201 Floor	W100 x D34 x H109,3 cm	2 pcs, W95,5 x D34 x H2,2 cm 4,5 kg W95,5 x D2,7 x H68 cm 12,0 kg W34,5 x D5,5 x H5,5 cm 0,9 kg W70 x D5,5 x H5,5 cm 1,8 kg W105 x D39,5 x H10,5 cm 6,4 kg	1 box 1 pcs.	14.552,00

VARIANT	DIMENSION	BOX DIMENSION WEIGHT	PACKAGING	PRICE
Combination 201 Wall	W100 x D34 x H109,3 cm	W4 x D5,5 x H5 cm 0,7 kg 2 pcs, W95,5 x D34 x H2,2 cm 4,5 kg W95,5 x D2,7 x H68 cm 12,0 kg W34,5 x D5,5 x H5,5 cm 0,9 kg W70 x D5,5 x H5,5 cm 1,8 kg	1 box 1 pcs.	13.432,00

COMBINATION 202



ITEM LIST

1 x NO Shelf Top 150 cm
 1 x NO Shelf Middle 150 cm
 1 x NO Shelf Bottom 150 cm
 2 x NO Single Profile | Set of 4
 Stock item

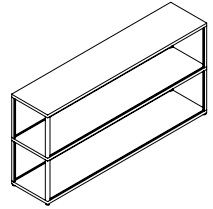

MATERIAL	COLOUR			
	Army	Charcoal	Light grey	Red
Powder coated aluminium	•	•	•	•

ITEM LIST	DIMENSION	BOX DIMENSION WEIGHT	PACKAGING	PRICE
Combination 202	W150 x D34 x H74 cm	2 pcs, W34,5 x D5,5 x H5,5 cm 0,9 kg W155 x D39,5 x H10,5 cm 9,1 kg W155 x D39,5 x H14 cm 9,2 kg W155 x D39,5 x H10,5 cm 9,0 kg	1 box 1 pcs.	9.144,00

COMBINATION 203

ITEM LIST

2 x NO Shelf Middle 100 cm
 2 x NO Shelf Bottom 100 cm
 2 x NO Tray Top 100 cm
 2 x NO Single Profile | Set of 4
 2 x NO Double Profile | Set of 2
 4 x NO Steel side panel 34 cm | Powder coated steel
 2 x NO Steel back panel 100 cm | Powder coated steel
 2 x NO Steel sliding door 100 cm | Incl. handle, powder coated steel
 Order produced

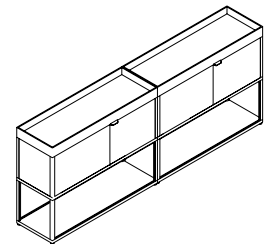

MATERIAL	COLOUR			
	Army	Charcoal	Light grey	
Powder coated aluminium	•	•	•	

VARIANT	DIMENSION	BOX DIMENSION WEIGHT	PACKAGING	PRICE
Combination 203	W200 x D34 x H79,7 cm	2 pcs, W95,5 x D2,7 x H33 cm 6,0 kg 2 pcs, W34,5 x D5,5 x H5,5 cm 0,9 kg 2 pcs, W34,5 x D5,5 x H5,5 cm 0,9 kg 2 pcs, W105 x D39,5 x H16 cm 5,9 kg 2 pcs, W105 x D39,5 x H14 cm 6,6 kg	1 box 1 pcs.	20.510,40

COMBINATION 204

ITEM LIST

1 x NO Shelf Middle 100 cm
 1 x NO Shelf Bottom 100 cm
 1 x NO Tray Top 100 cm
 1 x NO Single Profile | Set of 4
 2 x NO Steel side panel double height 34 cm | For adjustable shelf powder coated steel
 1 x NO Steel back panel double height 100 cm | Powder coated steel
 1 x NO Single Profile for double height | Set of 4
 2 x NO Steel shelf 100 cm | Incl. pin 4 pcs. for adjustable side panels powder coated steel
 1 x NO Steel sliding door double height 100 cm | Incl. handle powder coated steel
 Please remember to specify wall- or floor safety brackets when ordering this combination.
 Order produced

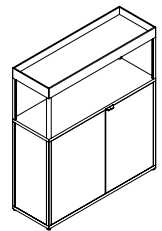

MATERIAL	COLOUR			
	Army	Charcoal	Light grey	
Powder coated aluminium	•	•	•	

VARIANT	DIMENSION	BOX DIMENSION WEIGHT	PACKAGING	PRICE
Combination 204 Floor	W100 x D34 x H115 cm	2 pcs, W95,5 x D34 x H2,2 cm 4,5 kg W95,5 x D2,7 x H68 cm 12,0 kg W40 x D2 x H1,5 cm 1,0 kg W34,5 x D5,5 x H5,5 cm 0,9 kg W70 x D5,5 x H5,5 cm 1,8 kg	1 box 1 pcs.	14.880,00

VARIANT	DIMENSION	BOX DIMENSION WEIGHT	PACKAGING	PRICE
Combination 204 Wall	W100 x D34 x H115 cm	W4 x D5,5 x H5 cm 0,7 kg 2 pcs, W95,5 x D34 x H2,2 cm 4,5 kg W95,5 x D2,7 x H68 cm 12,0 kg W34,5 x D5,5 x H5,5 cm 0,9 kg W70 x D5,5 x H5,5 cm 1,8 kg	1 box 1 pcs.	14.672,00

COMBINATION 205



ITEM LIST

- 1 x NO Shelf Top 100 cm
- 1 x NO Shelf Middle 100 cm
- 1 x NO Shelf Bottom 100 cm
- 1 x NO High drawer incl. Mounting set 100 cm
- 2 x NO Steel Side panel 34 cm
- 1 x NO Steel Back panel 100 cm
- 2 x NO Single profile | Set of 4

Please remember to specify wall- or floor safety brackets when ordering this combination.

Order produced

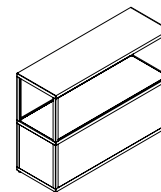

MATERIAL	COLOUR		
	Army	Charcoal	Light grey
Powder coated aluminium	•	•	•

VARIANT	DIMENSION	BOX DIMENSION WEIGHT	PACKAGING	PRICE
Combination 205 Floor	W100 x D34 x H74 cm	W95,5 x D34 x H32 cm 13,5 kg W6,6 x D34 x H33 cm 1,5 kg W6,6 x D34 x H33 cm 1,5 kg 2 pcs, W34,5 x D5,5 x H5,5 cm 0,9 kg W105 x D39,5 x H10,5 cm 6,4 kg	1 box 1 pcs.	14.655,20

VARIANT	DIMENSION	BOX DIMENSION WEIGHT	PACKAGING	PRICE
Combination 205 Wall	W100 x D34 x H74 cm	W4 x D5,5 x H5 cm 0,7 kg W95,5 x D34 x H32 cm 13,5 kg W6,6 x D34 x H33 cm 1,5 kg W6,6 x D34 x H33 cm 1,5 kg 2 pcs, W34,5 x D5,5 x H5,5 cm 0,9 kg	1 box 1 pcs.	14.655,20

COMBINATION 301

ITEM LIST

- 1 x NO Shelf Top 100 cm
- 2 x NO Shelf Middle 100 cm
- 1 x NO Shelf Bottom 100 cm
- 3 x NO Single Profile | Set of 4

Please remember to specify wall- or floor safety brackets when ordering this combination.

Stock item

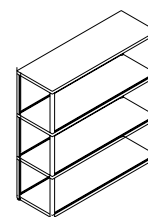

MATERIAL	COLOUR			
	Army	Charcoal	Light grey	Red
Powder coated aluminium	•	•	•	•

VARIANT	DIMENSION	BOX DIMENSION WEIGHT	PACKAGING	PRICE
Combination 301 Wall	W100 x D34 x H109,3 cm	W4 x D5,5 x H5 cm 0,7 kg 3 pcs, W34,5 x D5,5 x H5,5 cm 0,9 kg W105 x D39,5 x H10,5 cm 6,4 kg 2 pcs, W105 x D39,5 x H14 cm 6,6 kg W105 x D39,5 x H10,5 cm 6,2 kg	1 box 1 pcs.	8.976,00

VARIANT	DIMENSION	BOX DIMENSION WEIGHT	PACKAGING	PRICE
Combination 301 Floor	W100 x D34 x H109,3 cm	2 pcs, W40 x D2 x H1,5 cm 1,0 kg 3 pcs, W34,5 x D5,5 x H5,5 cm 0,9 kg W105 x D39,5 x H10,5 cm 6,4 kg 2 pcs, W105 x D39,5 x H14 cm 6,6 kg W105 x D39,5 x H10,5 cm 6,2 kg	1 box 1 pcs.	9.392,00

COMBINATION 303



ITEM LIST

- 2 x NO Shelf Middle 100 cm
- 1 x NO Shelf Bottom 100 cm
- 1 x NO Tray Top 100 cm
- 3 x NO Single Profile | Set of 4

Please remember to specify wall- or floor safety brackets when ordering this combination.

Stock item

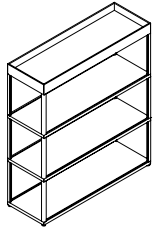

MATERIAL	COLOUR			
	Army	Charcoal	Light grey	Red
Powder coated aluminium	•	•	•	•

VARIANT	DIMENSION	BOX DIMENSION WEIGHT	PACKAGING	PRICE
Combination 303 Floor	W100 x D34 x H115 cm	3 pcs, W34,5 x D5,5 x H5,5 cm 0,9 kg W105 x D39,5 x H16 cm 5,9 kg 2 pcs, W105 x D39,5 x H14 cm 6,6 kg W105 x D39,5 x H10,5 cm 6,2 kg	1 box 1 pcs.	9.096,00

VARIANT	DIMENSION	BOX DIMENSION WEIGHT	PACKAGING	PRICE
Combination 303 Wall	W100 x D34 x H115 cm	W4 x D5,5 x H5 cm 0,7 kg 3 pcs, W34,5 x D5,5 x H5,5 cm 0,9 kg W105 x D39,5 x H16 cm 5,9 kg 2 pcs, W105 x D39,5 x H14 cm 6,6 kg W105 x D39,5 x H10,5 cm 6,2 kg	1 box 1 pcs.	9.096,00

COMBINATION 401

ITEM LIST

- 1 x NO Wooden panel and door set incl. handle 100 cm
- 1 x NO Shelf Top 100 cm
- 3 x NO Shelf Middle 100 cm
- 1 x NO Shelf Bottom 100 cm
- 4 x NO Single Profile | Set of 4

Please remember to specify floor safety brackets when ordering this combination.

Stock item

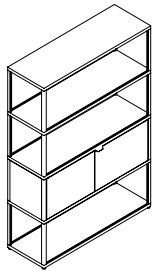

MATERIAL	COLOUR			
	Army	Charcoal	Light grey	Red
Powder coated aluminium	•	•	•	•

VARIANT	DIMENSION	BOX DIMENSION WEIGHT	PACKAGING	PRICE
Combination 401 Floor	W100 x D34 x H144,6 cm	4 pcs, W34,5 x D5,5 x H5,5 cm 0,9 kg W0 x D0 x H0 cm 0,0 kg W105 x D39,5 x H10,5 cm 6,4 kg 3 pcs, W105 x D39,5 x H14 cm 6,6 kg W105 x D39,5 x H10,5 cm 6,2 kg	1 box 1 pcs.	14.288,00

VARIANT	DIMENSION	BOX DIMENSION WEIGHT	PACKAGING	PRICE
Table Combination 401 Wall	W100 x D134 x H179,9 cm	W4 x D5,5 x H5 cm 0,7 kg 4 pcs, W34,5 x D5,5 x H5,5 cm 0,9 kg W0 x D0 x H0 cm 0,0 kg W105 x D39,5 x H10,5 cm 6,4 kg 3 pcs, W105 x D39,5 x H14 cm 6,6 kg	1 box 1 pcs.	14.288,00

COMBINATION 501



ITEM LIST

- 1 x NO Shelf Top 100 cm
- 4 x NO Shelf Middle 100 cm
- 1 x NO Shelf Bottom 100 cm
- 5 x NO Single Profile | Set of 4

Please remember to specify wall- or floor safety brackets when ordering this combination.

Stock item

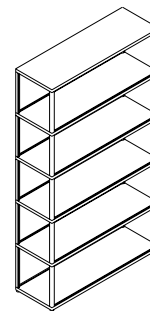

MATERIAL	COLOUR		
	Army	Charcoal	Light grey
Powder coated aluminium	•	•	•

VARIANT	DIMENSION	BOX DIMENSION WEIGHT	PACKAGING	PRICE
Combination 501 Floor	W100 x D34 x H179,9 cm	W40 x D2 x H1,5 cm 1,0 kg 5 W34,5 x D5,5 x H5,5 cm 0,9 kg W105 x D39,5 x H10,5 cm 6,4 kg 4 pcs, W105 x D39,5 x H14 cm 6,6 kg W105 x D39,5 x H10,5 cm 6,2 kg	1 box 1 pcs.	13.888,00

VARIANT	DIMENSION	BOX DIMENSION WEIGHT	PACKAGING	PRICE
Combination 501 Wall	W100 x D34 x H179,9 cm	W4 x D5,5 x H5 cm 0,7 kg 5 W34,5 x D5,5 x H5,5 cm 0,9 kg W105 x D39,5 x H10,5 cm 6,4 kg 4 pcs, W105 x D39,5 x H14 cm 6,6 kg W105 x D39,5 x H10,5 cm 6,2 kg	1 box 1 pcs.	13.680,00

COMBINATION 502

ITEM LIST

- 1 x NO Shelf Top 100 cm
 - 4 x NO Shelf Middle 100 cm
 - 1 x NO Shelf Bottom 100 cm
 - 5 x NO Single Profile | Set of 4
 - 2 x NO Steel side panel 34 cm | Powder coated steel
 - 1 x NO Steel back panel 100 cm | Powder coated steel
 - 1 x NO Steel sliding door 100 cm | Incl. handle powder coated steel
- Please remember to specify wall- or floor safety brackets when ordering this combination.
- Order produced

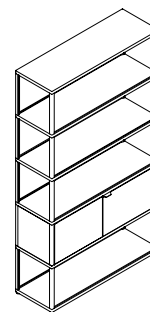

MATERIAL	COLOUR		
	Army	Charcoal	Light grey
Powder coated aluminium	•	•	•

VARIANT	DIMENSION	BOX DIMENSION WEIGHT	PACKAGING	PRICE
Combination 502 Floor	W100 x D34 x H179,9 cm	W95,5 x D2,7 x H33 cm 6,0 kg 5 W34,5 x D5,5 x H5,5 cm 0,9 kg W105 x D39,5 x H10,5 cm 6,4 kg 4 pcs, W105 x D39,5 x H14 cm 6,6 kg W105 x D39,5 x H10,5 cm 6,2 kg	1 box 1 pcs.	17.191,20

VARIANT	DIMENSION	BOX DIMENSION WEIGHT	PACKAGING	PRICE
Combination 502 Wall	W100 x D34 x H179,9 cm	W4 x D5,5 x H5 cm 0,7 kg W95,5 x D2,7 x H33 cm 6,0 kg 5 W34,5 x D5,5 x H5,5 cm 0,9 kg W105 x D39,5 x H10,5 cm 6,4 kg 4 pcs, W105 x D39,5 x H14 cm 6,6 kg	1 box 1 pcs.	17.191,20

COMBINATION 701



ITEM LIST

- 1 x NO Shelf Top 100 cm
- 6 x NO Shelf Middle 100 cm
- 1 x NO Shelf Bottom 100 cm
- 7 x NO Single Profile | Set of 4

Please remember to specify wall- or floor safety brackets when ordering this combination.

Stock item

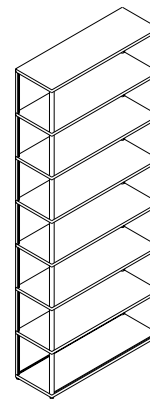

MATERIAL	COLOUR			
	Army	Charcoal	Light grey	Red
Powder coated aluminium	•	•	•	•

VARIANT	DIMENSION	BOX DIMENSION WEIGHT	PACKAGING	PRICE
Combination 701 Floor	W100 x D34 x H250,5 cm	7 W34,5 x D5,5 x H5,5 cm 0,9 kg W105 x D39,5 x H10,5 cm 6,4 kg 6 W105 x D39,5 x H14 cm 6,6 kg W105 x D39,5 x H10,5 cm 6,2 kg	1 box 1 pcs.	18.384,00

VARIANT	DIMENSION	BOX DIMENSION WEIGHT	PACKAGING	PRICE
Combination 701 Wall	W100 x D34 x H250,5 cm	W4 x D5,5 x H5 cm 0,7 kg 7 W34,5 x D5,5 x H5,5 cm 0,9 kg W105 x D39,5 x H10,5 cm 6,4 kg 6 W105 x D39,5 x H14 cm 6,6 kg W105 x D39,5 x H10,5 cm 6,2 kg	1 box 1 pcs.	18.384,00

COMBINATION 702

ITEM LIST

- 1 x NO Shelf Top 150 cm
 - 6 x NO Shelf Middle 150 cm
 - 1 x NO Shelf Bottom 150 cm
 - 7 x NO Single Profile | Set of 4
 - 4 x NO Steel side panel 34 cm | Powder coated steel
 - 2 x NO Steel back panel 150 cm | Powder coated steel
 - 2 x NO Steel sliding door 150 cm | Incl. handle, powder coated steel
- Please remember to specify wall- or floor safety brackets when ordering this combination.

Order produced

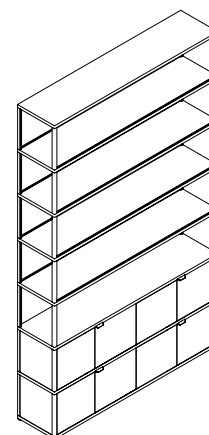

MATERIAL	COLOUR			
	Army	Charcoal	Light grey	
Powder coated aluminium	•	•	•	•

VARIANT	DIMENSION	BOX DIMENSION WEIGHT	PACKAGING	PRICE
Combination 702 Floor	W150 x D34 x H250,5 cm	2 pcs, W72,75 x D2,7 x H33 cm 4,5 kg 2 pcs, W72,75 x D2,7 x H33 cm 4,5 kg 7 W34,5 x D5,5 x H5,5 cm 0,9 kg W155 x D39,5 x H10,5 cm 9,1 kg 6 W155 x D39,5 x H14 cm 9,2 kg	1 box 1 pcs.	35.196,80

VARIANT	DIMENSION	BOX DIMENSION WEIGHT	PACKAGING	PRICE
Combination 702 Wall	W150 x D34 x H250,5 cm	W4 x D5,5 x H5 cm 0,7 kg 2 pcs, W72,75 x D2,7 x H33 cm 4,5 kg 2 pcs, W72,75 x D2,7 x H33 cm 4,5 kg 7 W34,5 x D5,5 x H5,5 cm 0,9 kg W155 x D39,5 x H10,5 cm 9,1 kg	1 box 1 pcs.	35.196,80

TABLE COMBINATION 401



ITEM LIST

- 1 x NO Legs H74 Army | Set of 2 w. 2 flat knots
- 1 x NO Table Connector Front 20 cm | Set of 2
- 1 x NO Shelf Top 100 cm
- 3 x NO Shelf Middle 100 cm
- 1 x NO Shelf Bottom 100 cm
- 3 x NO Single Profile | Set of 4
- 2 x NO Steel side panel double height 34 cm | For adjustable shelf | Powder coated steel
- 1 x NO Steel table back panel double height 100 cm | Powder coated steel
- 1 x NO Single Profile for double height | Set of 4
- 2 x NO Steel shelf 100 cm | Incl. pin 4 pcs. for adjustable side panels, powder coated steel
- 1 x NO Steel sliding door double height 100 cm | Incl. handle, powder coated steel
- 1 x NO Frame L100 x W100 F2
- 1 x NO Tabletop 100x100 L994 x W994 B

Please remember to specify wall- or floor safety brackets when ordering this combination.

Stock item

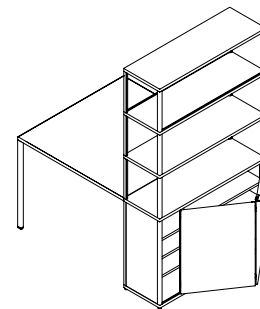

MATERIAL	COLOUR		
	Army	Charcoal	Light grey
Powder coated aluminium	•	•	•

VARIANT	DIMENSION	BOX DIMENSION WEIGHT	PACKAGING	PRICE
Table Combination 401 Floor	W100 x D134 x H179,9 cm	W163 x D42 x H16 cm 12,0 kg W120 x D120 x H2,5 cm 12,9 kg 2 pcs, W95,5 x D34 x H2,2 cm 4,5 kg W95,5 x D2,7 x H68 cm 12,0 kg 3 pcs, W34,5 x D5,5 x H5,5 cm 0,9 kg	1 box 1 pcs.	30.496,00

VARIANT	DIMENSION	BOX DIMENSION WEIGHT	PACKAGING	PRICE
Combination 401 Wall	W100 x D34 x H144,6 cm	W4 x D5,5 x H5 cm 0,7 kg 4 pcs, W34,5 x D5,5 x H5,5 cm 0,9 kg W0 x D0 x H0 cm 0,0 kg W105 x D39,5 x H10,5 cm 6,4 kg 3 pcs, W105 x D39,5 x H14 cm 6,6 kg	1 box 1 pcs.	14.288,00

COLOURS & MATERIALS

SHELVING SYSTEM & TABLE FRAME

Powder-coated aluminium & steel



ARMY

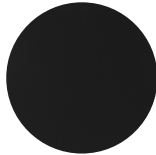

CHARCOAL



LIGHT GREY

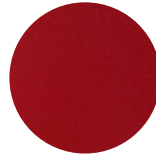

RED

*Not available for table frame and steel

TABLETOPS

Linoleum



GREEN

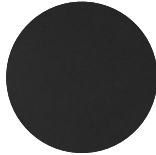

DARK GREY

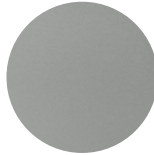

GREY

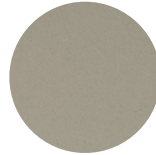

CLOUD GREY

Veneer



WATER-BASED LACQUERED OAK

WOODEN PANELS AND DOORS

Veneer



UNTREATED OAK VENEER



UNTREATED ASH VENEER

TEXTILE PANELS, TABLE SCREENS AND BENCHTOP

All textile colours available from each of the selected collections

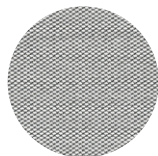

STEELCUT TRIO



STEELCUT

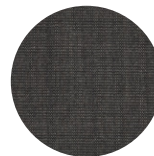

CANVAS

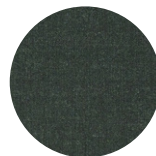

REMIX

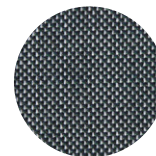

SURFACE BY HAY



LEATHER SENSE COGNAC (Benchtop only)



LEATHER SIERRA BLACK S11001 (Benchtop only)

GENERAL TERMS OF SALE AND DELIVERY

All sales are subject to our Sales Procedures for Dealers which can be found at hayb2b.com or be requested from your HAY sales contact person.

[LINK TO SALES PROCEDURES](#)

CARE & MAINTENANCE

Our Care & Maintenance offers guidance for optimal maintenance of your HAY product. It includes advice and instructions on cleaning and caring for specific materials to prolong the life of your furniture. Find the guide

[LINK TO CARE & MAINTENANCE](#)

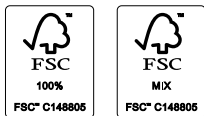

FSC™ CERTIFICATION

HAY is FSC™ certified. FSC (Forest Stewardship Council) is an international non-profit organisation and a labelling system for wood and paper that originate from certified forestry and other controlled sources. HAY's FSC license code is: FSC™-C148805. Only products that are identified as FSC™ are made from FSC-certified materials.

SUSTAINABILITY

HAY focuses on developing long-lasting products that minimise our environmental impact. We optimise the use of sustainable materials such as recycled materials, FSC-certified wood and water-based lacquer, with a growing number of eco-certified products. We have strict regulatory requirements, and the majority of our products are tested to comply with international standards for strength, durability and safety.

[LINK TO ENVIRONMENTAL PROFILE](#)

DOWNLOADS

Packshots and lifestyle photos, 2D / 3D files, care and maintenance, instructions, test certificates, product fact sheets, and product presentations are available in our Image Bank at hay.com.

[LINK TO IMAGE BANK](#)