

SWEDISH

Price List

2024



ocee & four
DESIGN



Hello, we are Ocee & Four Design!

We are on a mission to turn every good space into a great experience. Experience is about connecting with people, and that is why our furniture is designed with people in mind: How do they connect with others? What inspires and engages them? Where do they feel most comfortable? Who do they spend their time with? Why do they work in the way they do? These questions form the basis of the creative, comfortable, and productive spaces we work with our partners to create.

Our furniture solutions and products are highly curated to suit a variety of needs and spaces. We believe nothing beats family, and our products reflect that. You will find solutions that work together in perfect harmony to create beautiful spaces, while also maintaining their individual characteristics as standalone designs.

Ingenious design, unrivalled functionality, a focus on people, and a healthy dose of wonder – this is how we turn good spaces into great experiences.

FourSure® Family ↗



EU Ecolabel
FourSure®



FourSure® 44



FourSure® 88



FourSure® 90/105



FourSure® 66



FourSure® 77



FourSure® 11



FourSure® 99

FourCast® 2 Family ↗



EU Ecolabel
FourCast® 2



FourCast® 2 Four



FourCast® 2 Line



FourCast® 2 Counter /
High



FourCast® 2 Counter
Four / High Four



FourCast® 2 Wheeler



FourCast® 2 77



FourCast® 2 One



FourCast® 2 Fire
Retardant

FourMe® Family ↗



FourMe® 44



FourMe® 88



FourMe® 66

Share Family ↗



Share Basic



Share Stool



Share Bench

Upholstered Stools ↗



Casino

FourReal® Table Family ↗



FourReal® 74



FourReal® 741 Flake



FourReal® Flex



FourReal® 90



FourReal® 105



FourReal® A 74 /
A XL 74



FourReal® A Flex



FourReal® A 90 /
A XL 90



FourFold®



Acoustic Panels



Tray



Power Cube

Four® Tables ↗



Four® Learning



Four® Eating



Four® Meeting



Four® Standing
90 / 103



Four® Resting
H 51 / 64 / 72,5 / 103



Y-Table

Soft seating ↗



FourPeople®
Family



FourLikes®
Family



FourUs®
Family



Harc
Family

Acoustic ↗



InnoPod®

Links

[Sustainability ↗](#)

[Certificates ↗](#)

[Electrical accessories ↗](#)

[Accessories ↗](#)





[Colour codes ↗](#)

[Fabric bands ↗](#)

[Terms & Conditions ↗](#)

[Contact ↗](#)

Environmental Symbols

-  Eco-labelled product
-  Sustainability-marked product or component
-  Climate calculated product
-  Product that contains recycled or renewable material
-  Disassembled product



FEATURES



- The chair consists of 50 % recycled plastic
- Limitation of substances that are harmful to health and the environment
- Linking device optional on frames or under seat
- Matches table height 74 cm, 90 cm & 105 cm
- Polyamide glides as standard
- Stackable on matching trolley

For product information visit oceefour.com ↗

SHELL COLOURS

Standard Polypropylene









FRAME COLOURS

Standard

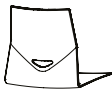

For full colour details [go to page 250](#) ↗

| Product | Description (Item nr) | Weight (Kg) | Stacking on floor | Dimensions (mm) | Band | Standard PP (SEK) |
|---------|----------------------------------------------------|-------------|-------------------|-----------------|------|-------------------|
| | 22500 FourSure® 44, Polypropylene shell | 5 | - | | - | 2.020 |
| | 23200 FourSure® 88, Polypropylene shell | 6 | - | | - | 2.479 |
| | 23800 FourSure® 90, Polypropylene shell | 6.9 | - | | - | 3.409 |
| | 23900 FourSure® 105, Polypropylene shell | 7.7 | - | | - | 3.492 |

| ACCESSORIES | Description | Weight (Kg) | Dimensions (mm) | Price (SEK) |
|-------------------------------------------------------------------------------------|-------------------------------------------------------------------------------|-------------|-----------------------------------------------------------------------|-------------|
| | CHAIR FEET Felt glides, set of 4 pcs. height + 0,2 cm | 1,82 g x 4 | | 208 |
| | CHAIR FEET Teflon glides, set of 4 pcs. Chair height + 0,2 cm | 2,75 g x 4 | | 208 |
|  | LINKING DEVICE Chair linking | 0,4 KG | C/C 535 mm C/C with armrest 585 mm C/C with Loop armrest 625 mm | 417 |
|  | LINKING DEVICE Chair linking | | C/C 540 mm C/C with armrest 540 mm | 390 |
|  | GRIP HOLE Available for chairs without inside – and full upholstery | | | 189 |
|  | SEAT ROW NUMBER - ACSR0201 11 mm - no. 1 -25 | 29 g | | 1.579 |
|  | SEAT ROW NUMBER - ACSR0202 11 mm - no. 26 -50 | 29 g | | 1.579 |
|  | SEAT ROW NUMBER - ACSR0101 16 mm - no. 1 -25 | 29 g | | 1.579 |
|  | SEAT ROW NUMBER - ACSR0102 16 mm - no. 26 -50 | 29 g | | 1.579 |
|  | CHAIR TROLLEY - 200X0 28 chairs without upholstery | 33,5 Kg | 1100 x 560 x 1970 mm | 8.859 |



FEATURES

- Armrest options and wooden legs options*
- Linking device under seat options
- Monochrome powder coating on frames options
- Polyamide glides as standard
- Inno® Note tablet options
- Stackable on matching trolley
- Outdoor options
- We do not recommend suspensions for fully upholstered version



For product information visit oceefour.com ↗

SHELL COLOURS

Standard Polypropylene



FRAME COLOURS

Standard





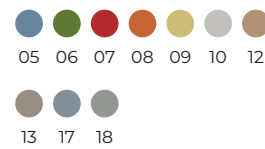



Optional Polypropylene



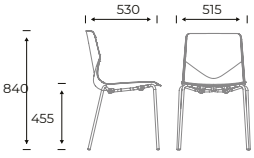

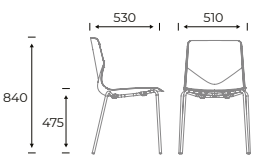

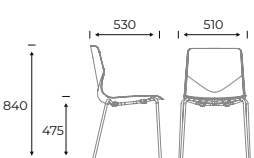

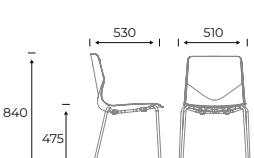
Frame optional*



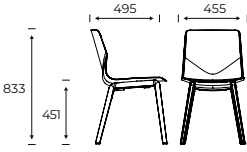

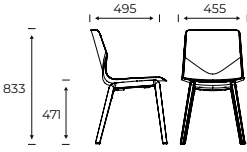

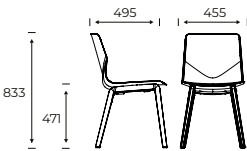

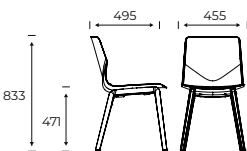

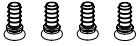

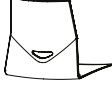

For full colour details [go to page 250](#) ↗

| Product | Description (Item nr) | Weight (Kg) | Stacking on floor | Dimensions (mm) | Band | Standard PP (SEK) | Optional PP (SEK) |
|-------------------------------------------------------------------------------------|---------------------------------------------------|-------------|-------------------|--------------------------------------------------------------------------------------|--------------------------------------------|-------------------------------------------------------------------------------|-------------------------------------------------------------------------------|
|  | 22500 FourSure® 44, Polypropylene shell | 5 | 12 |  | - | 2.020 | 2.211 |
|  | 22510 FourSure® 44, Seat pad | 5.9 | 10 |  | 1 2 3 4 5 6 7 8 10 | 3.282 3.377 3.472 3.566 3.658 3.754 3.849 3.943 4.161 | 3.473 3.568 3.663 3.757 3.849 3.945 4.040 4.134 4.352 |
|  | 22520 FourSure® 44, Inside upholstery | 6.3 | 8 |  | 1 2 3 4 5 6 7 8 10 | 4.438 4.629 4.821 5.010 5.202 5.393 5.584 5.774 6.158 | 4.629 4.820 5.012 5.201 5.393 5.584 5.775 5.965 6.349 |
|  | 22530 FourSure® 44, Fully upholstered | 5.7 | 6 |  | 1 2 3 4 5 6 7 8 10 | 4.719 4.940 5.161 5.382 5.601 5.824 6.044 6.265 6.748 | |

| Product | Description (Item nr) | Weight (Kg) | Stacking on floor | Dimensions (mm) | Band | Standard PP (SEK) | Optional PP (SEK) |
|-------------------------------------------------------------------------------------|----------------------------------------------------------------------|-------------|-------------------|--------------------------------------------------------------------------------------|--------------------------------------------|-------------------------------------------------------------------------------|-------------------------------------------------------------------------------|
|  | 22600 FourSure® 44 with Armrests, Polypropylene shell | 5.6 | 12 |  | - | 3.174 | 3.365 |
|  | 22610 FourSure® 44 with Armrests, Seat pad | 6.4 | 10 |  | 1 2 3 4 5 6 7 8 10 | 4.436 4.531 4.626 4.720 4.812 4.908 5.003 5.097 5.315 | 4.627 4.722 4.817 4.911 5.003 5.099 5.194 5.288 5.506 |
|  | 22620 FourSure® 44 with Armrests, Inside upholstery | 6.8 | 8 |  | 1 2 3 4 5 6 7 8 10 | 5.592 5.783 5.975 6.164 6.356 6.547 6.738 6.928 7.312 | 5.783 5.974 6.166 6.355 6.547 6.738 6.929 7.119 7.503 |
|  | 22630 FourSure® 44 with Armrests, Fully upholstered | 6.2 | 6 |  | 1 2 3 4 5 6 7 8 10 | 5.873 6.094 6.315 6.536 6.755 6.978 7.198 7.419 7.902 | |
|  | 22700 FourSure® 44 with Loop Armrests, Polypropylene shell | 6.1 | 12 |  | - | 3.174 | 3.365 |
|  | 22710 FourSure® 44 with Loop Armrests, Seat pad | 6.9 | 10 |  | 1 2 3 4 5 6 7 8 10 | 4.436 4.531 4.626 4.720 4.812 4.908 5.003 5.097 5.315 | 4.627 4.722 4.817 4.911 5.003 5.099 5.194 5.288 5.506 |
|  | 22720 FourSure® 44 with Loop Armrests, Inside upholstery | 7.3 | 8 |  | 1 2 3 4 5 6 7 8 10 | 5.592 5.783 5.975 6.164 6.356 6.547 6.738 6.928 7.312 | 5.783 5.974 6.166 6.355 6.547 6.738 6.929 7.119 7.503 |
|  | 22730 FourSure® 44 with Loop Armrests, Fully upholstered | 6.8 | 6 |  | 1 2 3 4 5 6 7 8 10 | 5.873 6.094 6.315 6.536 6.755 6.978 7.198 7.419 7.902 | |

| Product | Description (Item nr) | Weight (Kg) | Stacking on floor | Dimensions (mm) | Band | Standard PP (SEK) | Optional PP (SEK) |
|------------------------------------------------------------------------------------|------------------------------------------------------------------|-------------|----------------------|-------------------------------------------------------------------------------------|--------------------------------------------|-------------------------------------------------------------------------------|-------------------------------------------------------------------------------|
|  | 22500 FourSure® 44, Polypropylene shell, Oak lacquered | 5 | - |  | - | 3.748 | 3.939 |
|  | 22510 FourSure® 44, Seat pad, Oak lacquered | 5.9 | - |  | 1 2 3 4 5 6 7 8 10 | 5.010 5.105 5.200 5.294 5.386 5.482 5.577 5.671 5.889 | 5.201 5.296 5.391 5.485 5.577 5.673 5.768 5.862 6.080 |
|  | 22520 FourSure® 44, Inside upholstery, Oak lacquered | 6.3 | - |  | 1 2 3 4 5 6 7 8 10 | 6.166 6.357 6.549 6.738 6.930 7.121 7.312 7.503 7.886 | 6.357 6.548 6.740 6.929 7.121 7.312 7.503 7.693 8.077 |
|  | 22530 FourSure® 44, Fully upholstered, Oak lacquered | 5.7 | - |  | 1 2 3 4 5 6 7 8 10 | 6.447 6.668 6.889 7.110 7.329 7.552 7.772 7.993 8.476 | |

| ACCESSORIES | Description | Weight (Kg) | Dimensions (mm) | Price (SEK) |
|-------------------------------------------------------------------------------------|-------------------------------------------------------------------------------------------------------------------------------------------|-------------|-----------------------------------------------------------------------|-------------|
| | CHAIR FEET Felt glides, set of 4 pcs. height + 0,2 cm | 1,82 g x 4 | | 208 |
|  | CHAIR FEET Set of 4 pcs. Noise reducing ferrule with big diameter (reduces pressure marks) Chair height + 0,8 cm | 4,8 g x 4 | | 276 |
|  | CHAIR FEET Noise reducing ferrule with felt, set of 4 pcs. Chair height + 1 cm | 6,6 g x 4 | | 276 |
| | CHAIR FEET Teflon glides, set of 4 pcs. Chair height + 0,2 cm | 2,75 g x 4 | | 208 |
|  | LINKING DEVICE Chair linking | 0,4 KG | C/C 535 mm C/C with armrest 585 mm C/C with Loop armrest 625 mm | 417 |
|  | GRIP HOLE Available for chairs without inside – and full upholstery | | | 189 |
|  | INNO Inno® Note in black, removable and foldable. Not available for chairs with Loop armrest and chairs with wooden legs. | 1,4 KG | 225 x 325 x 10 mm | 1.522 |
|  | SEAT ROW NUMBER - ACSR0101 16 mm - no. 1 -25 | 29 g | | 1.579 |
|  | SEAT ROW NUMBER - ACSR0102 16 mm - no. 26 -50 | 29 g | | 1.579 |
|  | INNO@NOTE TROLLEY - 20100007 Trolley for Inno® Note. Room for 51 Inno® Notes. | 58,5 Kg | 1532 x 662 x 1199 mm | 19.942 |
|  | CHAIR TROLLEY - 200X0 28 chairs without upholstery | 33,5 Kg | 1100 x 560 x 1970 mm | 8.859 |
|  | CHAIR TROLLEY - 200X0 20 chairs with seat pad / inside upholstery or 18 chairs with full upholstery | 33,5 Kg | 1100 x 560 x 1910 / 1980 mm | 10.373 |
|  | SACK TROLLEY - 200X1 12 chairs without upholstery, 10 chairs with seat pad / inside upholstery or 6 chairs with full upholstery | | | 4.918 |

| SURCHARGE | | Price (SEK) |
|-----------------------|------------------------------------------------------------------------------------------------------------|-------------|
| FRAME OPTIONAL |  7 A D E F M N O Q S T | 194 |
| |  V | 476 |



FEATURES

- Armrest options
- Linking device optional on frames or under seat
- Monochrome powder coating on frames options
- Polyamide glides as standard
- Inno® Note tablet options
- Stackable on matching trolley
- Outdoor options
- We do not recommend suspensions for fully upholstered version

For product information visit oceefour.com ↗

SHELL COLOURS

Standard Polypropylene



FRAME COLOURS

Standard





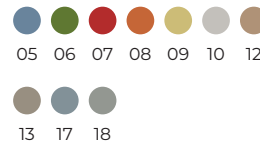



Optional Polypropylene



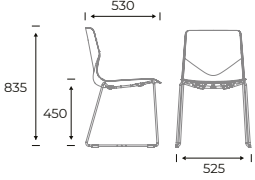

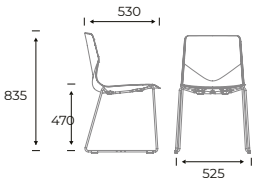

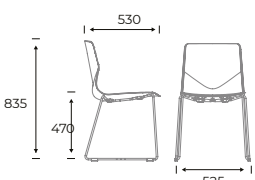

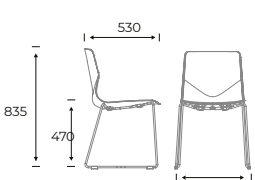

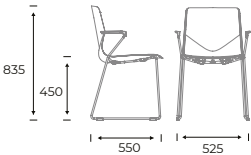

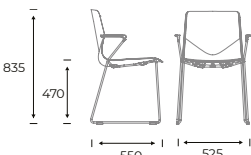

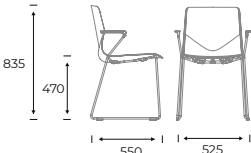

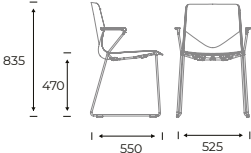

Frame optional*

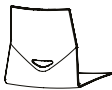

For full colour details [go to page 250](#) ↗

| Product | Description (Item nr) | Weight (Kg) | Stacking on floor | Dimensions (mm) | Band | Standard PP (SEK) | Optional PP (SEK) |
|-------------------------------------------------------------------------------------|---------------------------------------------------|-------------|-------------------|--------------------------------------------------------------------------------------|--------------------------------------------|-------------------------------------------------------------------------------|-------------------------------------------------------------------------------|
|  | 23200 FourSure® 88, Polypropylene shell | 6 | 12 |  | - | 2.479 | 2.670 |
|  | 23210 FourSure® 88, Seat pad | 6.8 | 10 |  | 1 2 3 4 5 6 7 8 10 | 3.741 3.836 3.931 4.025 4.117 4.213 4.308 4.402 4.620 | 3.932 4.027 4.122 4.216 4.308 4.404 4.499 4.593 4.811 |
|  | 23220 FourSure® 88, Inside upholstery | 7.2 | 10 |  | 1 2 3 4 5 6 7 8 10 | 4.897 5.088 5.280 5.469 5.661 5.852 6.043 6.233 6.617 | 5.088 5.279 5.471 5.660 5.852 6.043 6.234 6.424 6.808 |
|  | 23230 FourSure® 88, Fully upholstered | 6.6 | 8 |  | 1 2 3 4 5 6 7 8 10 | 5.178 5.399 5.620 5.841 6.060 6.283 6.503 6.724 7.207 | |

| Product | Description (Item nr) | Weight (Kg) | Stacking on floor | Dimensions (mm) | Band | Standard PP (SEK) | Optional PP (SEK) |
|------------------------------------------------------------------------------------|--------------------------------------------------------------------|-------------|----------------------|-------------------------------------------------------------------------------------|--------------------------------------------|-------------------------------------------------------------------------------|-------------------------------------------------------------------------------|
|  | 23300 FourSure® 88 with Armrests, Polypropylene shell | 6.7 | 12 |  | - | 3.609 | 3.800 |
|  | 23310 FourSure® 88 with Armrests, Seat pad | 7.5 | 10 |  | 1 2 3 4 5 6 7 8 10 | 4.871 4.966 5.061 5.155 5.247 5.343 5.438 5.532 5.750 | 5.062 5.157 5.252 5.346 5.438 5.534 5.629 5.723 5.941 |
|  | 23320 FourSure® 88 with Armrests, Inside upholstery | 7.9 | 10 |  | 1 2 3 4 5 6 7 8 10 | 6.027 6.218 6.410 6.599 6.791 6.982 7.173 7.363 7.747 | 6.218 6.409 6.601 6.790 6.982 7.173 7.364 7.554 7.938 |
|  | 23330 FourSure® 88 with Armrests, Fully upholstered | 7.4 | 8 |  | 1 2 3 4 5 6 7 8 10 | 6.308 6.529 6.750 6.971 7.190 7.413 7.633 7.854 8.337 | |

| ACCESSORIES | Description | Weight (Kg) | Dimensions (mm) | Price (SEK) |
|-------------------------------------------------------------------------------------|-------------------------------------------------------------------------------------------------------------------------------------|-------------|-----------------------------------------------------------------------|-------------|
| | CHAIR FEET Felt glides, set of 4 pcs. height + 0,2 cm | 1,82 g x 4 | | 208 |
| | CHAIR FEET Teflon glides, set of 4 pcs. Chair height + 0,2 cm | 2,75 g x 4 | | 208 |
|  | LINKING DEVICE Chair linking | 0,4 KG | C/C 535 mm C/C with armrest 585 mm C/C with Loop armrest 625 mm | 417 |
|  | LINKING DEVICE Chair linking | | C/C 540 mm C/C with armrest 540 mm | 390 |
|  | GRIP HOLE Available for chairs without inside – and full upholstery | | | 189 |
|  | INNO Inno® Note in black, removable and foldable. Not available for chairs with Loop armrest and chairs with wooden legs. | 1,4 KG | 225 x 325 x 10 mm | 1.522 |
|  | SEAT ROW NUMBER - ACSR0201 11 mm - no. 1 -25 | 29 g | | 1.579 |
|  | SEAT ROW NUMBER - ACSR0202 11 mm - no. 26 -50 | 29 g | | 1.579 |
|  | INNO@NOTE TROLLEY - 20100007 Trolley for Inno® Note. Room for 51 Inno® Notes. | 58,5 Kg | 1532 x 662 x 1199 mm | 19.942 |
|  | CHAIR TROLLEY - 200X0 35 chairs without upholstery | 33,5 Kg | 1100 x 560 x 1970 mm | 8.859 |
|  | CHAIR TROLLEY - 200X0 20 chairs with seat pad / inside upholstery or 18 chairs with full upholstery | 33,5 Kg | 1100 x 560 x 1910 / 1980 mm | 10.373 |
|  | SACK TROLLEY - 200X1 12 chairs without upholstery, 10 with seat pad / inside upholstery or 8 chairs with full upholstery | | | 4.918 |
| SURCHARGE | | | | Price (SEK) |
| FRAME OPTIONAL |  7 A D E F M N O Q S T | | | 194 |



FEATURES

- Fits table height 90 cm
- Stackable on floor
- Polyamide glides as standard
- Monochrome powder coating on frames options
- Outdoor options
- We do not recommend suspensions to fully upholstered version



For product information visit oceefour.com ↗

SHELL COLOURS

Standard Polypropylene



FRAME COLOURS

Standard





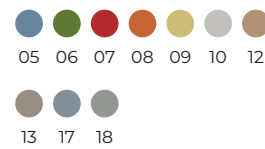



Optional Polypropylene



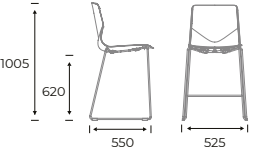

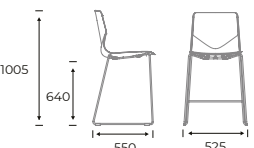

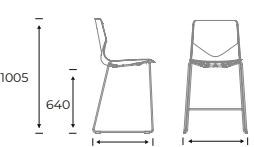

Frame optional*

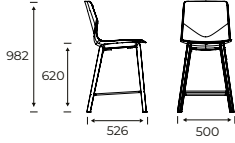

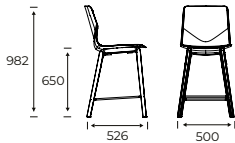
For full colour details [go to page 250](#) ↗

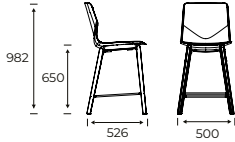
| Product | Description (Item nr) | Weight (Kg) | Stacking on floor | Dimensions (mm) | Band | Standard PP (SEK) | Optional PP (SEK) |
|-------------------------------------------------------------------------------------|---------------------------------------------------|-------------|-------------------|--------------------------------------------------------------------------------------|--------------------------------------------|-------------------------------------------------------------------------------|-------------------------------------------------------------------------------|
|  | 23800 FourSure® 90, Polypropylene shell | 6.9 | 4 |  | - | 3.409 | 3.600 |
|  | 23810 FourSure® 90, Seat pad | 7.8 | 4 |  | 1 2 3 4 5 6 7 8 10 | 4.671 4.766 4.861 4.955 5.047 5.143 5.238 5.332 5.550 | 4.862 4.957 5.052 5.146 5.238 5.334 5.429 5.523 5.741 |
|  | 23820 FourSure® 90, Inside upholstery | 8.1 | 4 |  | 1 2 3 4 5 6 7 8 10 | 5.827 6.018 6.210 6.399 6.591 6.782 6.973 7.163 7.547 | 6.018 6.209 6.401 6.590 6.782 6.973 7.164 7.354 7.738 |
|  | 23830 FourSure® 90, Fully upholstered | 7.6 | 4 |  | 1 2 3 4 5 6 7 8 10 | 6.108 6.329 6.550 6.771 6.990 7.213 7.433 7.654 8.137 | |

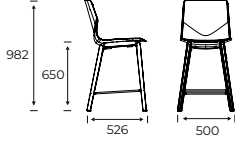
| Product | Description (Item nr) | Weight (Kg) | Stacking on floor | Dimensions (mm) | Band | Standard PP (SEK) | Optional PP (SEK) |
|-------------------------------------------------------------------------------------|------------------------------------------------------------------|-------------|-------------------|--------------------------------------------------------------------------------------|--------------------------------------------|-------------------------------------------------------------------------------|-------------------------------------------------------------------------------|
|  | 23800 FourSure® 90, Polypropylene shell, Oak lacquered | 6.9 | - |  | - | 5.170 | 5.361 |
|  | 23810 FourSure® 90, Seat pad, Oak lacquered | 7.8 | - |  | 1 2 3 4 5 6 7 8 10 | 6.432 6.527 6.622 6.716 6.808 6.904 6.999 7.093 7.311 | 6.623 6.718 6.813 6.907 6.999 7.095 7.190 7.284 7.502 |
|  | 23820 FourSure® 90, Inside upholstery, Oak lacquered | 8.1 | - |  | 1 2 3 4 5 6 7 8 10 | 7.588 7.779 7.971 8.160 8.352 8.543 8.734 8.924 9.308 | 7.779 7.970 8.162 8.351 8.543 8.734 8.925 9.115 9.499 |
|  | 23830 FourSure® 90, Fully upholstered, Oak lacquered | 7.6 | - |  | 1 2 3 4 5 6 7 8 10 | 7.869 8.090 8.311 8.532 8.751 8.974 9.194 9.415 9.898 | |

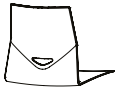
| ACCESSORIES | Description | Weight (Kg) | Dimensions (mm) | Price (SEK) |
|-------------------------------------------------------------------------------------|-------------------------------------------------------------------------------|-------------|-----------------|-------------|
| | CHAIR FEET Felt glides, set of 4 pcs. height + 0,2 cm | 1,82 g x 4 | | 208 |
| | CHAIR FEET Teflon glides, set of 4 pcs. Chair height + 0,2 cm | 2,75 g x 4 | | 208 |
|  | GRIP HOLE Available for chairs without inside – and full upholstery | | | 189 |

| SURCHARGE | | Price (SEK) |
|-----------------------|----------------------------------------------------------------------------------------------------------------------------------------------------------------------------------------------------------|-------------|
| FRAME OPTIONAL |  7 A D E F M N O Q S T  V | 194 475 |



FEATURES

- Fits table height 105 cm
- Stackable on floor
- Polyamide glides as standard
- Monochrome powder coating on frames options
- Outdoor options
- We do not recommend suspensions to fully upholstered version



For product information visit oceefour.com ↗

SHELL COLOURS

Standard Polypropylene



FRAME COLOURS

Standard



Optional Polypropylene

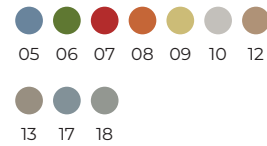







Frame optional*

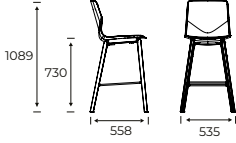

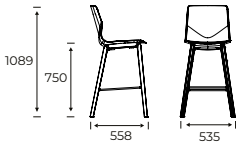
For full colour details [go to page 250](#) ↗

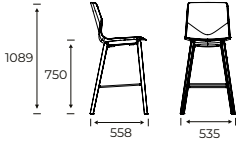
| Product | Description (Item nr) | Weight (Kg) | Stacking on floor | Dimensions (mm) | Band | Standard PP (SEK) | Optional PP (SEK) |
|---------|----------------------------------------------------|-------------|-------------------|-----------------|--------------------------------------------|-------------------------------------------------------------------------------|-------------------------------------------------------------------------------|
| | 23900 FourSure® 105, Polypropylene shell | 7.7 | 4 | | - | 3.492 | 3.683 |
| | 23910 FourSure® 105, Seat pad | 8.5 | 4 | | 1 2 3 4 5 6 7 8 10 | 4.754 4.849 4.944 5.038 5.130 5.226 5.321 5.415 5.633 | 4.945 5.040 5.135 5.229 5.321 5.417 5.512 5.606 5.824 |
| | 23920 FourSure® 105, Inside upholstery | 8.9 | 4 | | 1 2 3 4 5 6 7 8 10 | 5.910 6.101 6.293 6.482 6.674 6.865 7.056 7.246 7.630 | 6.101 6.292 6.484 6.673 6.865 7.056 7.247 7.437 7.821 |
| | 23930 FourSure® 105, Fully upholstered | 8.4 | 4 | | 1 2 3 4 5 6 7 8 10 | 6.191 6.412 6.633 6.854 7.073 7.296 7.516 7.737 8.220 | |

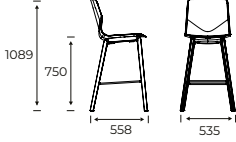
| Product | Description (Item nr) | Weight (Kg) | Stacking on floor | Dimensions (mm) | Band | Standard PP (SEK) | Optional PP (SEK) |
|-------------------------------------------------------------------------------------|-------------------------------------------------------------------|-------------|-------------------|--------------------------------------------------------------------------------------|--------------------------------------------|--------------------------------------------------------------------------------|-------------------------------------------------------------------------------|
|  | 23900 FourSure® 105, Polypropylene shell, Oak lacquered | 7.7 | - |  | - | 5.366 | 5.557 |
|  | 23910 FourSure® 105, Seat pad, Oak lacquered | 8.5 | - |  | 1 2 3 4 5 6 7 8 10 | 6.628 6.723 6.818 6.912 7.004 7.100 7.195 7.289 7.507 | 6.819 6.914 7.009 7.103 7.195 7.291 7.386 7.480 7.698 |
|  | 23920 FourSure® 105, Inside upholstery, Oak lacquered | 8.9 | - |  | 1 2 3 4 5 6 7 8 10 | 7.784 7.975 8.167 8.356 8.548 8.739 8.930 9.120 9.504 | 7.975 8.166 8.358 8.547 8.739 8.930 9.121 9.311 9.695 |
|  | 23930 FourSure® 105, Fully upholstered, Oak lacquered | 8.4 | - |  | 1 2 3 4 5 6 7 8 10 | 8.065 8.286 8.507 8.728 8.947 9.170 9.390 9.611 10.094 | |

| ACCESSORIES | Description | Weight (Kg) | Dimensions (mm) | Price (SEK) |
|-------------------------------------------------------------------------------------|-------------------------------------------------------------------------------|-------------|-----------------|-------------|
| | CHAIR FEET Felt glides, set of 4 pcs. height + 0,2 cm | 1,82 g x 4 | | 208 |
| | CHAIR FEET Teflon glides, set of 4 pcs. Chair height + 0,2 cm | 2,75 g x 4 | | 208 |
|  | GRIP HOLE Available for chairs without inside – and full upholstery | | | 189 |

| SURCHARGE | | Price (SEK) |
|-----------------------|----------------------------------------------------------------------------------------------------------------------------------------------------------------------------------------------------------|-------------|
| FRAME OPTIONAL |  7 A D E F M N O Q S T  V | 194 474 |



FEATURES

- Inno® Tab, flexible and rotating writing tablet options
- Gas lift, 41 - 57,5 cm
- Free Float options
- Black base with castors as standard
- Aluminium base options
- We do not recommend suspensions to fully upholstered version



For product information visit oceefour.com ↗

SHELL COLOURS

Standard Polypropylene



FRAME COLOURS

Standard





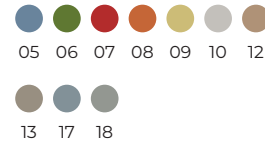



Optional Polypropylene



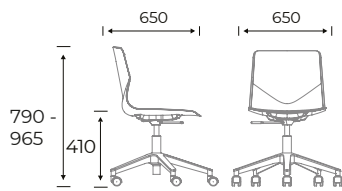

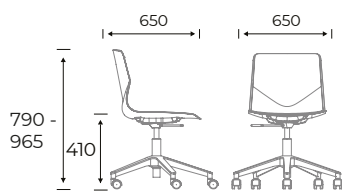

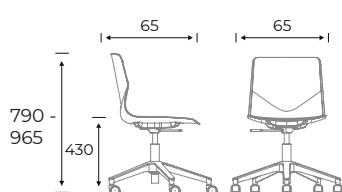

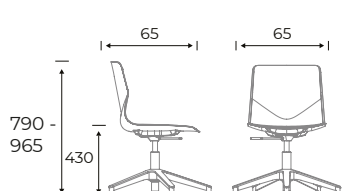

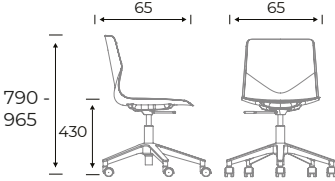

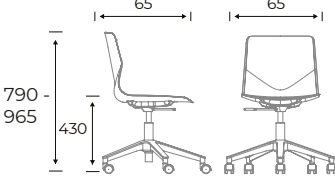

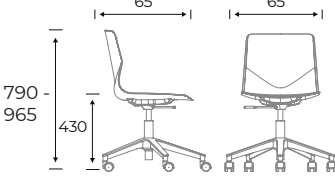

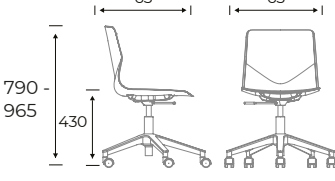





Frame optional*



For full colour details [go to page 250](#) ↗

| Product | Description (Item nr) | Weight (Kg) | Dimensions (mm) | Band | Standard PP (SEK) | Optional PP (SEK) |
|-------------------------------------------------------------------------------------|--------------------------------------------------------------------------|-------------|--------------------------------------------------------------------------------------|--------------------------------------------|-------------------------------------------------------------------------------|-------------------------------------------------------------------------------|
|  | 25004 FourSure® 66, Polypropylene shell, Without tilt with gas | 7.4 |  | - | 2.783 | 2.974 |
|  | 25005 FourSure® 66, Polypropylene shell, With tilt with gas | 7.5 |  | - | 3.147 | 3.338 |
|  | 25014 FourSure® 66, Seat pad, Without tilt with gas | 8 |  | 1 2 3 4 5 6 7 8 10 | 4.045 4.140 4.235 4.329 4.421 4.517 4.612 4.706 4.924 | 4.236 4.331 4.426 4.520 4.612 4.708 4.803 4.897 5.115 |
|  | 25015 FourSure® 66, Seat pad, With tilt with gas | 8 |  | 1 2 3 4 5 6 7 8 10 | 4.409 4.504 4.599 4.693 4.785 4.881 4.976 5.070 5.288 | 4.600 4.695 4.790 4.884 4.976 5.072 5.167 5.261 5.479 |

| Product | Description (Item nr) | Weight (Kg) | Dimensions (mm) | Band | Standard PP (SEK) | Optional PP (SEK) |
|-------------------------------------------------------------------------------------|---------------------------------------------------------------------------------------------|-------------|--------------------------------------------------------------------------------------|--------------------------------------------|-------------------------------------------------------------------------------|-------------------------------------------------------------------------------|
|  | 25024 FourSure® 66, Inside upholstery, Without tilt with gas | 8.4 |  | 1 2 3 4 5 6 7 8 10 | 5.201 5.392 5.584 5.773 5.965 6.156 6.347 6.537 6.921 | 5.392 5.583 5.775 5.964 6.156 6.347 6.538 6.728 7.112 |
|  | 25025 FourSure® 66, Inside upholstery, With tilt with gas | 8.4 |  | 1 2 3 4 5 6 7 8 10 | 5.565 5.756 5.948 6.137 6.329 6.520 6.711 6.901 7.285 | 5.756 5.947 6.139 6.328 6.520 6.711 7.092 7.476 |
|  | 25034 FourSure® 66, Fully upholstered, Without tilt with gas | 7.8 |  | 1 2 3 4 5 6 7 8 10 | 5.482 5.703 5.924 6.145 6.364 6.587 6.807 7.028 7.511 | |
|  | 25035 FourSure® 66, Fully upholstered, With tilt with gas | 13.7 |  | 1 2 3 4 5 6 7 8 10 | 5.846 6.067 6.288 6.509 6.728 6.951 7.171 7.392 7.875 | |
|  | 24905 FourSure® 66 with Loop Armrests, Polypropylene shell, With tilt with gas | 8.7 |  | - | 4.291 | 4.482 |
|  | 24915 FourSure® 66 with Loop Armrests, Seat pad, With tilt with gas | 9.4 |  | 1 2 3 4 5 6 7 8 10 | 5.553 5.648 5.743 5.837 5.929 6.025 6.120 6.214 6.432 | 5.744 5.839 5.934 6.028 6.120 6.216 6.311 6.405 6.623 |
|  | 24925 FourSure® 66 with Loop Armrests, Inside upholstery, With tilt with gas | 9.7 |  | 1 2 3 4 5 6 7 8 10 | 6.709 6.900 7.092 7.281 7.473 7.664 7.855 8.045 8.429 | 6.900 7.091 7.283 7.472 7.664 7.855 8.046 8.236 8.620 |
|  | 24935 FourSure® 66 with Loop Armrests, Fully upholstered, With tilt with gas | 9.2 |  | 1 2 3 4 5 6 7 8 10 | 6.990 7.211 7.432 7.653 7.872 8.095 8.315 8.536 9.019 | |

| ACCESSORIES | Description | Weight (Kg) | Dimensions (mm) | Price (SEK) |
|------------------------------------------------------------------------------------|-----------------------------------------------------------------------------------------------------------|-------------|-------------------|-------------|
|  | HOOK Hook in black | | | 47 |
|  | CHAIR FEET Standard polymide glides. Chair height + 0,2 cm | | | |
| | CHAIR FEET Castor with breaks, hard | | | 599 |
|  | FOOTRING Gas lift including footring Spand 41 cm. - 57,5 cm. | | 585 - 845 mm | 1.368 |
| | With GS certification | | | 1.489 |
|  | INNO Foldable Inno® Tab in black with integrated cup holder and dashboard for tablet and phone. | 2,7 KG | 520 x 320 x 23 mm | 2.125 |
| SURCHARGE | | | | Price (SEK) |
| FRAME OPTIONAL |  4 | | | 643 |



FEATURES

- Armrest options
- Stackable on floor
- Monochrome powder coating on frames options
- We do not recommend suspensions for fully upholstered version

For product information visit oceefour.com ↗

SHELL COLOURS

Standard Polypropylene



Optional Polypropylene

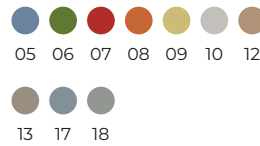

FRAME COLOURS

Standard



Frame optional*









For full colour details [go to page 250](#) ↗

| Product | Description (Item nr) | Weight (Kg) | Stacking on floor | Dimensions (mm) | Band | Standard PP (SEK) | Optional PP (SEK) |
|---------|---------------------------------------------------|-------------|-------------------|-----------------|--------------------------------------------|-------------------------------------------------------------------------------|-------------------------------------------------------------------------------|
| | 22800 FourSure® 77, Polypropylene shell | 6 | 7 | | - | 2.464 | 2.655 |
| | 22810 FourSure® 77, Seat pad | 6.9 | 5 | | 1 2 3 4 5 6 7 8 10 | 3.726 3.821 3.916 4.010 4.102 4.198 4.293 4.387 4.605 | 3.917 4.012 4.107 4.201 4.293 4.389 4.484 4.578 4.796 |
| | 22820 FourSure® 77, Inside upholstery | 7.3 | 5 | | 1 2 3 4 5 6 7 8 10 | 4.882 5.073 5.265 5.454 5.646 5.837 6.028 6.218 6.602 | 5.073 5.264 5.456 5.645 5.837 6.028 6.219 6.409 6.793 |
| | 22830 FourSure® 77, Fully upholstered | 6.8 | 5 | | 1 2 3 4 5 6 7 8 10 | 5.163 5.384 5.605 5.826 6.045 6.268 6.488 6.709 7.192 | |

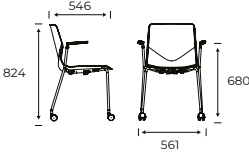
FourSure® 77

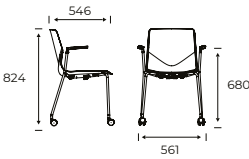
Design by Strand+Hvass

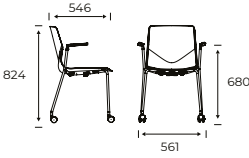
[Content ↗](#)

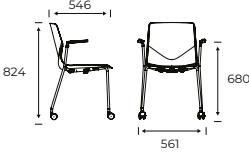
| Product | Description (Item nr) | Weight (Kg) | Stacking on floor | Dimensions (mm) | Band | Standard PP (SEK) | Optional PP (SEK) |
|------------------------------------------------------------------------------------|-----------------------------------------------------------------|-------------|-------------------|-------------------------------------------------------------------------------------|--------------------------------------------|-------------------------------------------------------------------------------|-------------------------------------------------------------------------------|
|  | 22900 FourSure® 77 with Armrests, Polypropylene shell | 7.5 | - |  | - | 3.618 | 3.809 |
|  | 22910 FourSure® 77 with Armrests, Seat pad | 8 | - |  | 1 2 3 4 5 6 7 8 10 | 4.880 4.975 5.070 5.164 5.256 5.352 5.447 5.541 5.759 | 5.071 5.166 5.261 5.355 5.447 5.543 5.638 5.732 5.950 |
|  | 22920 FourSure® 77 with Armrests, Inside upholstery | 8.4 | - |  | 1 2 3 4 5 6 7 8 10 | 6.036 6.227 6.419 6.608 6.800 6.991 7.182 7.372 7.756 | 6.227 6.418 6.610 6.799 6.991 7.182 7.373 7.563 7.947 |
|  | 22930 FourSure® 77 with Armrests, Fully upholstered | 8.2 | - |  | 1 2 3 4 5 6 7 8 10 | 6.317 6.538 6.759 6.980 7.199 7.422 7.642 7.863 8.346 | |

| ACCESSORIES | Description | Weight (Kg) | Dimensions (mm) | Price (SEK) |
|-------------------------------------------------------------------------------------|-------------------------------------------------------------------------------|-------------|-----------------|-------------|
|  | GRIP HOLE Available for chairs without inside – and full upholstery | | | 189 |

| SURCHARGE | Price (SEK) |
|--------------------------------------------------------------------------------------------------------------|-------------|
| FRAME OPTIONAL  | 194 |



FEATURES

- Armrest options
- Swivel with freefloat in seat/back
- Return mechanism options
- Polyamide glides as standard
- Teflon or felt glides and soft castor options
- Soft castor options (fixed cone without swivel and return)
- We do not recommend suspensions to fully upholstered version

For product information visit oceefour.com ↗

SHELL COLOURS

Standard Polypropylene



FRAME COLOURS





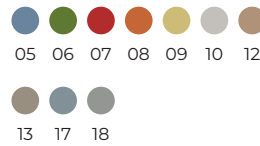

Standard



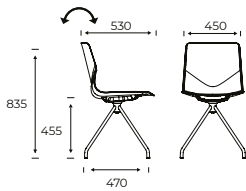

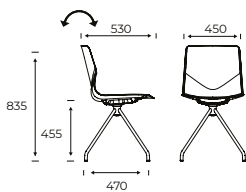

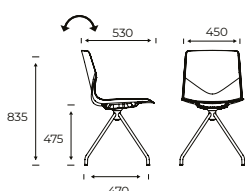

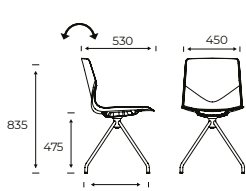

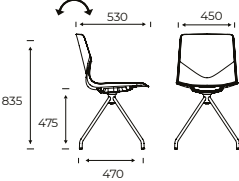

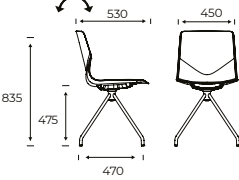

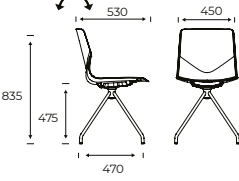

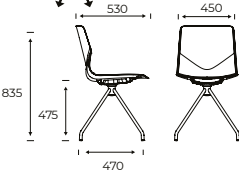

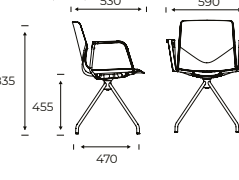

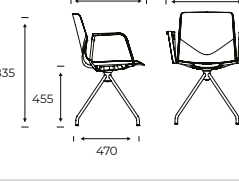

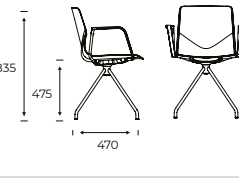

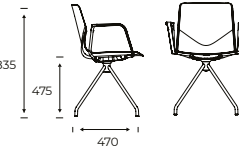
Optional Polypropylene



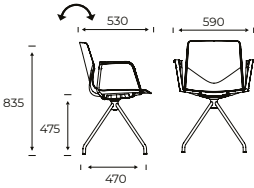

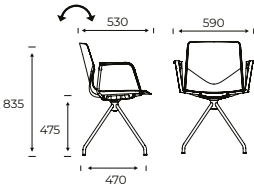
For full colour details [go to page 250](#) ↗

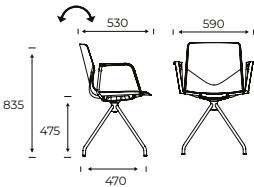
| Product | Description (Item nr) | Weight (Kg) | Dimensions (mm) | Band | Standard PP (SEK) | Optional PP (SEK) |
|-------------------------------------------------------------------------------------|--------------------------------------------------------------------------|-------------|--------------------------------------------------------------------------------------|--------------------------------------------|-------------------------------------------------------------------------------|-------------------------------------------------------------------------------|
|  | 23001 FourSure® 11, Polypropylene shell, With tilt | 6.7 |  | - | 3.627 | 3.818 |
|  | 23003 FourSure® 11, Polypropylene shell, With tilt with return | 6.6 |  | - | 4.800 | 4.991 |
|  | 23011 FourSure® 11, Seat pad, With tilt | 7.1 |  | 1 2 3 4 5 6 7 8 10 | 4.889 4.984 5.079 5.173 5.265 5.361 5.456 5.550 5.768 | 5.080 5.175 5.270 5.364 5.456 5.552 5.647 5.741 5.959 |
|  | 23013 FourSure® 11, Seat pad, With tilt with return | 7.1 |  | 1 2 3 4 5 6 7 8 10 | 6.062 6.157 6.252 6.346 6.438 6.534 6.629 6.723 6.941 | 6.253 6.348 6.443 6.537 6.629 6.725 6.820 6.914 7.132 |

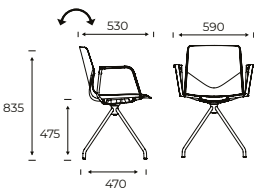
| Product | Description (Item nr) | Weight (Kg) | Dimensions (mm) | Band | Standard PP (SEK) | Optional PP (SEK) |
|-------------------------------------------------------------------------------------|---------------------------------------------------------------------------------------------|-------------|--------------------------------------------------------------------------------------|--------------------------------------------|-------------------------------------------------------------------------------|-------------------------------------------------------------------------------|
|  | 23021 FourSure® 11, Inside upholstery, With tilt | 7.5 |  | 1 2 3 4 5 6 7 8 10 | 6.045 6.236 6.428 6.617 6.809 7.000 7.191 7.381 7.765 | 6.236 6.427 6.619 6.808 7.000 7.191 7.382 7.572 7.956 |
|  | 23023 FourSure® 11, Inside upholstery, With tilt with return | 7.4 |  | 1 2 3 4 5 6 7 8 10 | 7.218 7.409 7.601 7.790 7.982 8.173 8.364 8.554 8.938 | 7.409 7.600 7.792 7.981 8.173 8.364 8.555 8.745 9.129 |
|  | 23031 FourSure® 11, Fully upholstered, With tilt | 7 |  | 1 2 3 4 5 6 7 8 10 | 6.326 6.547 6.768 6.989 7.208 7.431 7.651 7.872 8.355 | |
|  | 23033 FourSure® 11, Fully upholstered, With tilt with return | 6.9 |  | 1 2 3 4 5 6 7 8 10 | 7.499 7.720 7.941 8.162 8.381 8.604 8.824 9.045 9.528 | |
|  | 23101 FourSure® 11 with Loop Armrests, Polypropylene shell, With tilt | 7.8 |  | - | 4.780 | 4.971 |
|  | 23103 FourSure® 11 with Loop Armrests, Polypropylene shell, With tilt with return | 7.7 |  | - | 5.953 | 6.144 |
|  | 23111 FourSure® 11 with Loop Armrests, Seat pad, With tilt | 8.3 |  | 1 2 3 4 5 6 7 8 10 | 6.042 6.137 6.232 6.326 6.418 6.514 6.609 6.703 6.921 | 6.233 6.328 6.423 6.517 6.609 6.705 6.800 6.894 7.112 |
|  | 23113 FourSure® 11 with Loop Armrests, Seat pad, With tilt with return | 8.2 |  | 1 2 3 4 5 6 7 8 10 | 7.215 7.310 7.405 7.499 7.591 7.687 7.782 7.876 8.094 | 7.406 7.501 7.596 7.690 7.782 7.878 7.973 8.067 8.285 |

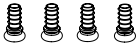
| Product | Description (Item nr) | Weight (Kg) | Dimensions (mm) | Band | Standard PP (SEK) | Optional PP (SEK) |
|-------------------------------------------------------------------------------------|-------------------------------------------------------------------------------------------|-------------|-------------------------------------------------------------------------------------|--------------------------------------------|---------------------------------------------------------------------------------|--------------------------------------------------------------------------------|
|  | 23121 FourSure® 11 with Loop Armrests, Inside upholstery, With tilt | 8.7 |  | 1 2 3 4 5 6 7 8 10 | 7.198 7.389 7.581 7.770 7.962 8.153 8.344 8.534 8.918 | 7.389 7.580 7.772 7.961 8.153 8.344 8.535 8.725 9.109 |
|  | 23123 FourSure® 11 with Loop Armrests, Inside upholstery, With tilt with return | 8.6 |  | 1 2 3 4 5 6 7 8 10 | 8.371 8.562 8.754 8.943 9.135 9.326 9.517 9.707 10.091 | 8.562 8.753 8.945 9.134 9.326 9.517 9.708 9.898 10.282 |
|  | 23131 FourSure® 11 with Loop Armrests, Fully upholstered, With tilt | 7.9 |  | 1 2 3 4 5 6 7 8 10 | 7.479 7.700 7.921 8.142 8.361 8.584 8.804 9.025 9.508 | |
|  | 23133 FourSure® 11 with Loop Armrests, Fully upholstered, With tilt with return | 8.1 |  | 1 2 3 4 5 6 7 8 10 | 8.652 8.873 9.094 9.315 9.534 9.757 9.977 10.198 10.681 | |

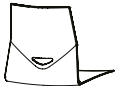
| ACCESSORIES | Description | Weight (Kg) | Dimensions (mm) | Price (SEK) |
|-------------------------------------------------------------------------------------|-----------------------------------------------------------------------------------------------------------------------------|-------------|-----------------|-------------|
| | CHAIR FEET Castors | | | 876 |
| | CHAIR FEET Felt glides, set of 4 pcs. height + 0,2 cm | 1,82 g x 4 | | 208 |
|  | CHAIR FEET Set of 4 pcs. Noise reducing ferrule with big diameter (reduces pressure marks) Chair height + 0,8 cm | 4,8 g x 4 | | 276 |
|  | CHAIR FEET Noise reducing ferrule with felt, set of 4 pcs. Chair height + 1 cm | 6,6 g x 4 | | 276 |
| | CHAIR FEET Teflon glides, set of 4 pcs. Chair height + 0,2 cm | 2,75 g x 4 | | 208 |
|  | GRIP HOLE Available for chairs without inside – and full upholstery | | | 189 |



FEATURES

- Swivel frame with free float seat/back as standard
- Return mechanism options
- Loop Armchair options
- Polyamide glides as standard
- Teflon or felt glides and soft castor options
- Powder coated frame options
- We do not recommend suspensions to fully upholstered version



For product information visit oceefour.com ↗

SHELL COLOURS

Standard Polypropylene



FRAME COLOURS

Standard



Optional Polypropylene

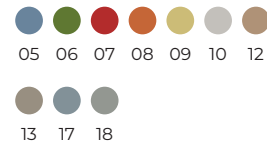









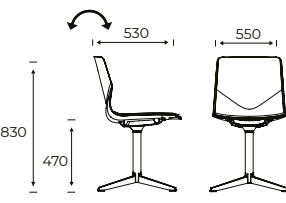

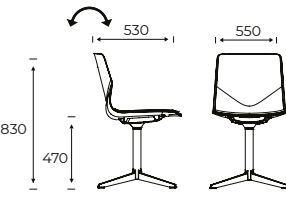

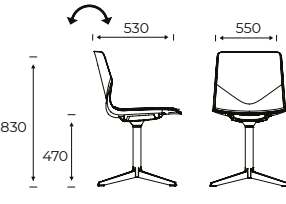

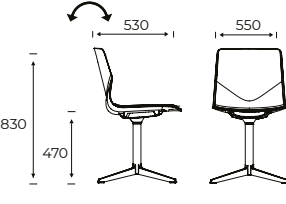

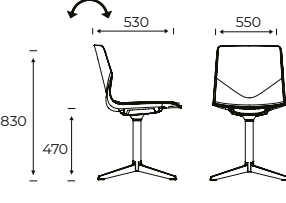

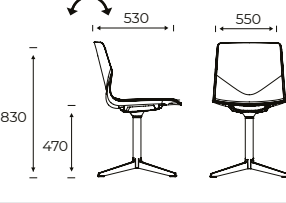

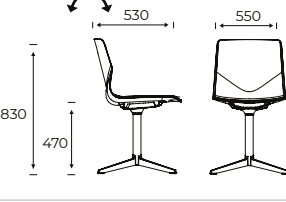

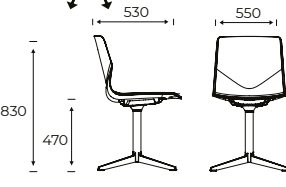



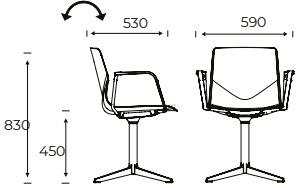

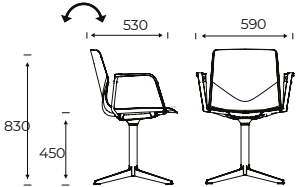

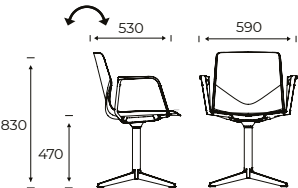
Frame optional*

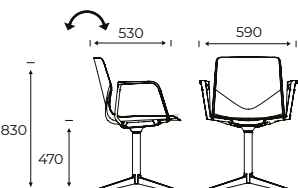

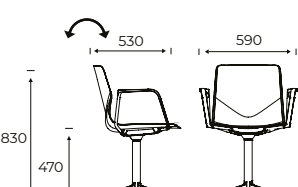

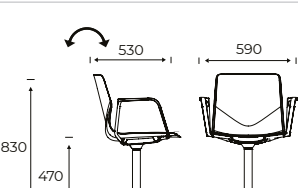

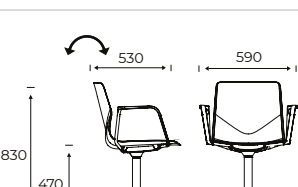

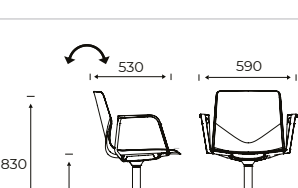
For full colour details [go to page 250](#) ↗

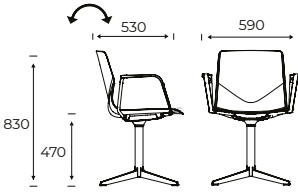
| Product | Description (Item nr) | Weight (Kg) | Dimensions (mm) | Band | Standard PP (SEK) | Optional PP (SEK) |
|---------|--------------------------------------------------------------------------|-------------|-----------------|--------------------------------------------|-------------------------------------------------------------------------------|-------------------------------------------------------------------------------|
| | 24001 FourSure® 99, Polypropylene shell, With tilt | 7.2 | | - | 4.767 | 4.958 |
| | 24003 FourSure® 99, Polypropylene shell, With tilt with return | 7.2 | | - | 5.267 | 5.458 |
| | 24005 FourSure® 99, Polypropylene shell, With tilt with gas | 7.7 | | - | 5.267 | 5.458 |
| | 24011 FourSure® 99, Seat pad, With tilt | 7.7 | | 1 2 3 4 5 6 7 8 10 | 6.029 6.124 6.219 6.313 6.405 6.501 6.596 6.690 6.908 | 6.220 6.315 6.410 6.504 6.596 6.692 6.787 6.881 7.099 |

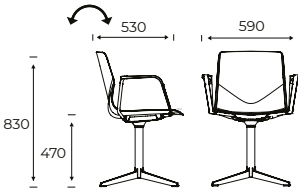
| Product | Description (Item nr) | Weight (Kg) | Dimensions (mm) | Band | Standard PP (SEK) | Optional PP (SEK) |
|-------------------------------------------------------------------------------------|------------------------------------------------------------------------|-------------|--------------------------------------------------------------------------------------|--------------------------------------------|-------------------------------------------------------------------------------|-------------------------------------------------------------------------------|
|  | 24013 FourSure® 99, Seat pad, With tilt with return | 7.7 |  | 1 2 3 4 5 6 7 8 10 | 6.529 6.624 6.719 6.813 6.905 7.001 7.096 7.190 7.408 | 6.720 6.815 6.910 7.004 7.096 7.192 7.287 7.381 7.599 |
|  | 24015 FourSure® 99, Seat pad, With tilt with gas | 8.6 |  | 1 2 3 4 5 6 7 8 10 | 6.529 6.624 6.719 6.813 6.905 7.001 7.096 7.190 7.408 | 6.720 6.815 6.910 7.004 7.096 7.192 7.287 7.381 7.599 |
|  | 24021 FourSure® 99, Inside upholstery, With tilt | 8.1 |  | 1 2 3 4 5 6 7 8 10 | 7.185 7.376 7.568 7.757 7.949 8.140 8.331 8.521 8.905 | 7.376 7.567 7.759 7.948 8.140 8.331 8.522 8.712 9.096 |
|  | 24023 FourSure® 99, Inside upholstery, With tilt with return | 8.1 |  | 1 2 3 4 5 6 7 8 10 | 7.685 7.876 8.068 8.257 8.449 8.640 8.831 9.021 9.405 | 7.876 8.067 8.259 8.448 8.640 8.831 9.022 9.212 9.596 |
|  | 24025 FourSure® 99, Inside upholstery, With tilt with gas | 9 |  | 1 2 3 4 5 6 7 8 10 | 7.685 7.876 8.068 8.257 8.449 8.640 8.831 9.021 9.405 | 7.876 8.067 8.259 8.448 8.640 8.831 9.022 9.212 9.596 |
|  | 24031 FourSure® 99, Fully upholstered, With tilt | 7.5 |  | 1 2 3 4 5 6 7 8 10 | 7.466 7.687 7.908 8.129 8.348 8.571 8.791 9.012 9.495 | |
|  | 24033 FourSure® 99, Fully upholstered, With tilt with return | 7.5 |  | 1 2 3 4 5 6 7 8 10 | 7.966 8.187 8.408 8.629 8.848 9.071 9.291 9.512 9.995 | |
|  | 24035 FourSure® 99, Fully upholstered, With tilt with gas | - |  | 1 2 3 4 5 6 7 8 10 | 7.966 8.187 8.408 8.629 8.848 9.071 9.291 9.512 9.995 | |

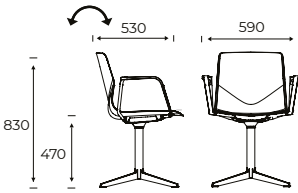
| Product | Description (Item nr) | Weight (Kg) | Dimensions (mm) | Band | Standard PP (SEK) | Optional PP (SEK) |
|-------------------------------------------------------------------------------------|------------------------------------------------------------------------------------------------|-------------|--------------------------------------------------------------------------------------|--------------------------------------------|---------------------------------------------------------------------------------|----------------------------------------------------------------------------------|
|  | 24101 FourSure® 99 with Loop Armrests, Polypropylene shell, With tilt | 8.5 |  | - | 5.918 | 6.109 |
|  | 24103 FourSure® 99 with Loop Armrests, Polypropylene shell, With tilt with return | 8.5 |  | - | 6.418 | 6.609 |
|  | 24105 FourSure® 99 with Loop Armrests, Polypropylene shell, With tilt with gas | 9.5 |  | - | 6.418 | 6.609 |
|  | 24111 FourSure® 99 with Loop Armrests, Seat pad, With tilt | 9.1 |  | 1 2 3 4 5 6 7 8 10 | 7.180 7.275 7.370 7.464 7.556 7.652 7.747 7.841 8.059 | 7.371 7.466 7.561 7.655 7.747 7.843 7.938 8.032 8.250 |
|  | 24113 FourSure® 99 with Loop Armrests, Seat pad, With tilt with return | 9 |  | 1 2 3 4 5 6 7 8 10 | 7.680 7.775 7.870 7.964 8.056 8.152 8.247 8.341 8.559 | 7.871 7.966 8.061 8.155 8.247 8.343 8.438 8.532 8.750 |
|  | 24115 FourSure® 99 with Loop Armrests, Seat pad, With tilt with gas | 10 |  | 1 2 3 4 5 6 7 8 10 | 7.680 7.775 7.870 7.964 8.056 8.152 8.247 8.341 8.559 | 7.871 7.966 8.061 8.155 8.247 8.343 8.438 8.532 8.750 |
|  | 24121 FourSure® 99 with Loop Armrests, Inside upholstery, With tilt | 9.4 |  | 1 2 3 4 5 6 7 8 10 | 8.336 8.527 8.719 8.908 9.100 9.291 9.482 9.672 10.056 | 8.527 8.718 8.910 9.099 9.291 9.482 9.673 9.863 10.247 |
|  | 24123 FourSure® 99 with Loop Armrests, Inside upholstery, With tilt with return | 9.4 |  | 1 2 3 4 5 6 7 8 10 | 8.836 9.027 9.219 9.408 9.600 9.791 9.982 10.172 10.556 | 9.027 9.218 9.410 9.599 9.791 9.982 10.173 10.363 10.747 |

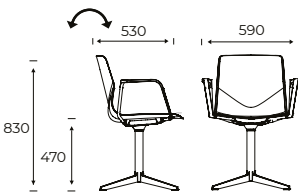
| Product | Description (Item nr) | Weight (Kg) | Dimensions (mm) | Band | Standard PP (SEK) | Optional PP (SEK) |
|-------------------------------------------------------------------------------------|-------------------------------------------------------------------------------------------|-------------|-------------------------------------------------------------------------------------|--------------------------------------------|-----------------------------------------------------------------------------------|----------------------------------------------------------------------------------|
|  | 24125 FourSure® 99 with Loop Armrests, Inside upholstery, With tilt with gas | 10.4 |  | 1 2 3 4 5 6 7 8 10 | 8.836 9.027 9.219 9.408 9.600 9.791 9.982 10.172 10.556 | 9.027 9.218 9.410 9.599 9.791 9.982 10.173 10.363 10.747 |
|  | 24131 FourSure® 99 with Loop Armrests, Fully upholstered, With tilt | 8.8 |  | 1 2 3 4 5 6 7 8 10 | 8.617 8.838 9.059 9.280 9.499 9.722 9.942 10.163 10.646 | |
|  | 24133 FourSure® 99 with Loop Armrests, Fully upholstered, With tilt with return | 8.8 |  | 1 2 3 4 5 6 7 8 10 | 9.117 9.338 9.559 9.780 9.999 10.222 10.442 10.663 11.146 | |
|  | 24135 FourSure® 99 with Loop Armrests, Fully upholstered, With tilt with gas | 8.5 |  | 1 2 3 4 5 6 7 8 10 | 9.117 9.338 9.559 9.780 9.999 10.222 10.442 10.663 11.146 | |

| ACCESSORIES | Description | Weight (Kg) | Dimensions (mm) | Price (SEK) |
|-------------|-----------------------------------------------------------------|-------------|-----------------|-------------|
| | CHAIR FEET Castors | | | 1.154 |
| | CHAIR FEET Felt glides, set of 4 pcs. height + 0,2 cm | 1,82 g x 4 | | 208 |

| SURCHARGE | | Price (SEK) |
|-----------------------|----------------------------------------------------------------------------------------------|-------------|
| FRAME OPTIONAL |  B C K | 1058 |

EU Ecolabel FourCast® 2

Design by Strand+Hvass

[Content ↗](#)



FEATURES



- The chair consists of 50 % recycled plastic
- Limitation of substances that are harmful to health and the environment
- Linking device optional on frames or under seat
- Matches table height 74 cm, 90 cm & 105 cm
- Polyamide glides as standard
- Stackable on matching trolley

For product information visit oceefour.com ↗

SHELL COLOURS

Standard Polypropylene







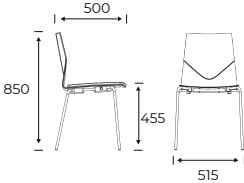

FRAME COLOURS

Standard

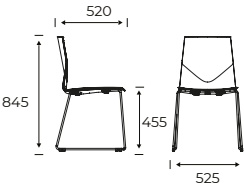

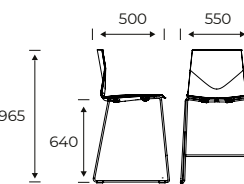

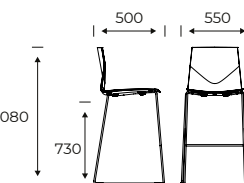
For full colour details [go to page 236](#) ↗







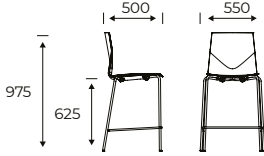

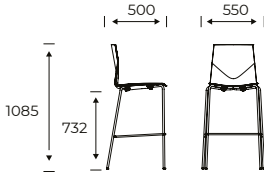
| Product | Description (Item nr) | Weight (Kg) | Stacking on floor | Dimensions (mm) | Band | Standard PP (SEK) |
|------------------------------------------------------------------------------------|-------------------------------------------------------------|-------------|-------------------|--------------------------------------------------------------------------------------|------|-------------------|
|  | 32500 FourCast® 2 Four, Polypropylene shell | 4.8 | - |  | - | 2.290 |
|  | 33200 FourCast® 2 Line, Polypropylene shell | 5.7 | - |  | - | 2.776 |
|  | 33800 FourCast® 2 Counter, Polypropylene shell | 6.6 | - |  | - | 3.730 |
|  | 33900 FourCast® 2 High, Polypropylene shell | 7.3 | - |  | - | 3.815 |

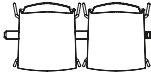
EU Ecolabel FourCast® 2

[Content ↗](#)

Design by Strand+Hvass

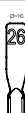
| Product | Description (Item nr) | Weight (Kg) | Stacking on floor | Dimensions (mm) | Band | Standard PP (SEK) |
|-----------------------------------------------------------------------------------|------------------------------------------------------------------|-------------|-------------------|------------------------------------------------------------------------------------|------|-------------------|
|  | 34000 FourCast@ 2 Counter Four, Polypropylene shell | 7.7 | - |  | - | 3.492 |
|  | 34100 FourCast@ 2 High Four, Polypropylene shell | 6.7 | - |  | - | 3.492 |

| ACCESSORIES | Description | Weight (Kg) | Dimensions (mm) | Price (SEK) |
|-------------------------------------------------------------------------------------|-------------------------------------------------------------------------------|-------------|-----------------------------------------------------------------------|-------------|
| | CHAIR FEET Felt glides, set of 4 pcs. height + 0,2 cm | 1,82 g x 4 | | 208 |
| | CHAIR FEET Teflon glides, set of 4 pcs. Chair height + 0,2 cm | 2,75 g x 4 | | 208 |
|  | LINKING DEVICE Chair linking | 0,4 KG | C/C 535 mm C/C with armrest 585 mm C/C with Loop armrest 625 mm | 417 |
|  | LINKING DEVICE Chair linking | | C/C 540 mm C/C with armrest 540 mm | 390 |
|  | GRIP HOLE Available for chairs without inside – and full upholstery | | | 189 |
|  | SEAT ROW NUMBER - ACSR0201 11 mm - no. 1 -25 | 29 g | | 1.579 |
|  | SEAT ROW NUMBER - ACSR0202 11 mm - no. 26 -50 | 29 g | | 1.579 |
|  | SEAT ROW NUMBER - ACSR0101 16 mm - no. 1 -25 | 29 g | | 1.579 |
|  | SEAT ROW NUMBER - ACSR0102 16 mm - no. 26 -50 | 29 g | | 1.579 |
|  | CHAIR TROLLEY - 200X0 25 chairs without upholstery | 33,5 Kg | 1100 x 560 x 1970 mm | 8.859 |

FourCast® 2 Four

Design by Strand+Hvass

[Content ↗](#)



FEATURES

- Armrest options and wooden legs options*
- Linking device under seat options
- Monochrome powder coating on frames options
- Polyamide glides as standard
- Inno® Note tablet options
- Stackable on matching trolley
- We do not recommend suspensions for fully upholstered versions



For product information visit oceefour.com ↗

SHELL COLOURS

Standard Polypropylene



FRAME COLOURS

Standard





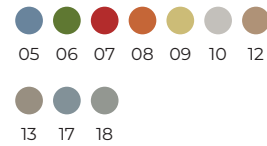



Optional Polypropylene

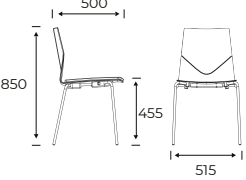

Frame optional*

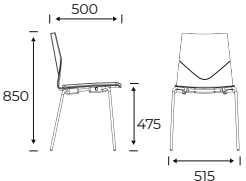

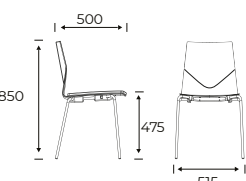

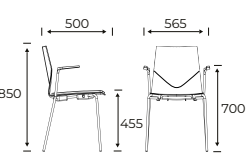



For full colour details [go to page 236](#) ↗



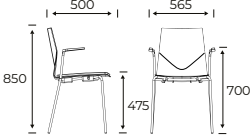

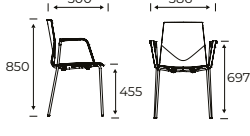

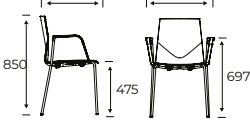

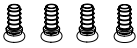

| Product | Description (Item nr) | Weight (Kg) | Stacking on floor | Dimensions (mm) | Band | Standard PP (SEK) | Optional PP (SEK) |
|------------------------------------------------------------------------------------|---------------------------------------------------------------------|-------------|-------------------|--------------------------------------------------------------------------------------|--------------------------------------------|-------------------------------------------------------------------------------|-------------------------------------------------------------------------------|
|  | 32500 FourCast® 2 Four, Polypropylene shell | 4.8 | 12 |  | - | 2.290 | 2.481 |
|  | 32510 FourCast® 2 Four, Seat pad | 5.8 | 10 |  | 1 2 3 4 5 6 7 8 10 | 3.552 3.647 3.742 3.836 3.928 4.024 4.119 4.213 4.431 | 3.743 3.838 3.933 4.027 4.119 4.215 4.310 4.404 4.622 |
|  | 32530 FourCast® 2 Four, Fully upholstered | 4.1 | 6 |  | 1 2 3 4 5 6 7 8 10 | 4.999 5.220 5.443 5.663 5.882 6.103 6.325 6.544 7.030 | |
|  | 32600 FourCast® 2 Four with Armrests, Polypropylene shell | 5.3 | 12 |  | - | 3.443 | 3.634 |

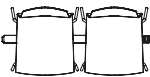
FourCast® 2 Four

Design by Strand+Hvass

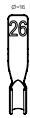
[Content ↗](#)

| Product | Description (Item nr) | Weight (Kg) | Stacking on floor | Dimensions (mm) | Band | Standard PP (SEK) | Optional PP (SEK) |
|-------------------------------------------------------------------------------------|-----------------------------------------------------------------------------|-------------|----------------------|--------------------------------------------------------------------------------------|-------------------------------------------------------------------------------------|---------------------------------------------------------------------------|----------------------|
|  | 32610 FourCast® 2 Four with Armrests, Seat pad | 6.3 | 10 |  | 1 | 4.705 | 4.896 |
| | | | | | 2 | 4.800 | 4.991 |
| | | | | | 3 | 4.895 | 5.086 |
| | | | | | 4 | 4.989 | 5.180 |
| | | | | | 5 | 5.081 | 5.272 |
| | | | | | 6 | 5.177 | 5.368 |
| | | | | | 7 | 5.272 | 5.463 |
| | | | | | 8 | 5.366 | 5.557 |
| | | | | | 10 | 5.584 | 5.775 |
| | | | | |  | 32630 FourCast® 2 Four with Armrests, Fully upholstered | 4.6 |
| 2 | 6.373 | | | | | | |
| 3 | 6.596 | | | | | | |
| 4 | 6.816 | | | | | | |
| 5 | 7.035 | | | | | | |
| 6 | 7.256 | | | | | | |
| 7 | 7.478 | | | | | | |
| 8 | 7.697 | | | | | | |
| 10 | 8.183 | | | | | | |
|  | 32700 FourCast® 2 Four with Loop Armrests, Polypropylene shell | 5.9 | 12 |  | | | |
|  | 32710 FourCast® 2 Four with Loop Armrests, Seat pad | 6.8 | 10 |  | 1 | 4.705 | 4.896 |
| | | | | | 2 | 4.800 | 4.991 |
| | | | | | 3 | 4.895 | 5.086 |
| | | | | | 4 | 4.989 | 5.180 |
| | | | | | 5 | 5.081 | 5.272 |
| | | | | | 6 | 5.177 | 5.368 |
| | | | | | 7 | 5.272 | 5.463 |
| | | | | | 8 | 5.366 | 5.557 |
| | | | | | 10 | 5.584 | 5.775 |
| | | | | |  | 32730 FourCast® 2 Four with Loop Armrests, Fully upholstered | 5.2 |
| 2 | 6.373 | | | | | | |
| 3 | 6.596 | | | | | | |
| 4 | 6.816 | | | | | | |
| 5 | 7.035 | | | | | | |
| 6 | 7.256 | | | | | | |
| 7 | 7.478 | | | | | | |
| 8 | 7.697 | | | | | | |
| 10 | 8.183 | | | | | | |

| ACCESSORIES | Description | Weight (Kg) | Dimensions (mm) | Price (SEK) |
|-------------------------------------------------------------------------------------|-------------------------------------------------------------------------------------------------------------------------------------|-------------|-----------------------------------------------------------------------|-------------|
| | CHAIR FEET Felt glides, set of 4 pcs. height + 0,2 cm | 1,82 g x 4 | | 208 |
|  | CHAIR FEET Set of 4 pcs. Noise reducing ferrule with big diameter (reduces pressure marks) Chair height + 0,8 cm | 4,8 g x 4 | | 276 |
|  | CHAIR FEET Noise reducing ferrule with felt, set of 4 pcs. Chair height + 1 cm | 6,6 g x 4 | | 276 |
| | CHAIR FEET Teflon glides, set of 4 pcs. Chair height + 0,2 cm | 2,75 g x 4 | | 208 |
|  | LINKING DEVICE Chair linking | 0,4 KG | C/C 535 mm C/C with armrest 585 mm C/C with Loop armrest 625 mm | 417 |
|  | GRIP HOLE Available for chairs without inside – and full upholstery | | | 189 |
|  | INNO Inno® Note in black, removable and foldable. Not available for chairs with Loop armrest and chairs with wooden legs. | 1,4 KG | 225 x 325 x 10 mm | 1.522 |
|  | SEAT ROW NUMBER - ACSR0101 16 mm - no.1 -25 | 29 g | | 1.579 |
|  | SEAT ROW NUMBER - ACSR0102 16 mm - no.26 -50 | 29 g | | 1.579 |
|  | INNO@NOTE TROLLEY - 20100007 Trolley for Inno® Note. Room for 51 Inno® Notes. | 58,5 Kg | 1532 x 662 x 1199 mm | 19.942 |
|  | CHAIR TROLLEY - 200X0 25 chairs without upholstery | 33,5 Kg | 1100 x 560 x 1970 mm | 8.859 |
|  | CHAIR TROLLEY - 200X0 20 chairs with seat pad or 18 chairs with full upholstery | 33,5 Kg | 1100 x 560 x 1910 / 1980 mm | 10.373 |
|  | SACK TROLLEY - 200X1 12 chairs without upholstery, 10 chairs with full upholstery | | | 4.918 |

FourCast® 2 Four

Design by Strand+Hvass

| SURCHARGE | | Price (SEK) |
|----------------|------------------------------------------------------------------------------------------------------------|-------------|
| FRAME OPTIONAL |  7 A D E F M N O Q S T | 194 |

FourCast® 2 Four - Veneer

Design by Strand+Hvass

[Content ↗](#)



FEATURES

- Armrest options and wooden legs options*
- Linking device under seat options
- Monochrome powder coating on frames options
- Polyamide glides as standard
- Inno® Note tablet options
- Stackable on matching trolley
- We do not recommend suspensions to black lacquered versions



For product information visit oceefour.com ↗

SHELL COLOURS

Veneer



FRAME COLOURS







Standard

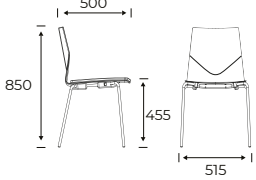

Frame optional*

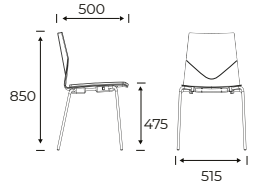

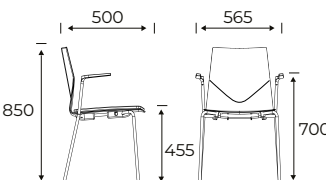
For full colour details [go to page 236](#) ↗

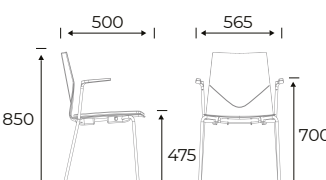
| Product | Description (Item nr) | Weight (Kg) | Stacking on floor | Dimensions (mm) | Band | Veneer (SEK) |
|------------------------------------------------------------------------------------|------------------------------------------------------------------------|-------------|-------------------|--------------------------------------------------------------------------------------|--------------------------------------------|-------------------------------------------------------------------------------|
|  | 32540 FourCast® 2 Four, Wooden shell | 3.3 | 12 |  | - | 3.212 |
|  | 32550 FourCast® 2 Four, Seat pad, wooden shell | 4.8 | 10 |  | 1 2 3 4 5 6 7 8 10 | 4.474 4.569 4.664 4.758 4.850 4.946 5.041 5.135 5.353 |
|  | 32640 FourCast® 2 Four with Armrests, Wooden shell | 3.9 | 6 |  | - | 4.365 |
|  | 32650 FourCast® 2 Four with Armrests, Seat pad, wooden shell | 5.3 | 12 |  | 1 2 3 4 5 6 7 8 10 | 5.627 5.722 5.817 5.911 6.003 6.099 6.194 6.288 6.506 |

FourCast® 2 Four - Veneer

[Content ↗](#)



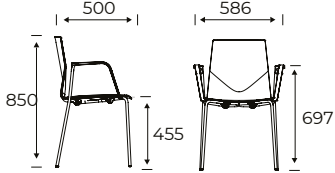
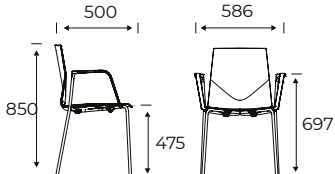





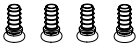

Design by Strand+Hvass

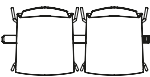
| Product | Description (Item nr) | Weight (Kg) | Stacking on floor | Dimensions (mm) | Band | Veneer (SEK) |
|-----------------------------------------------------------------------------------|-----------------------------------------------------------------------------|-------------|-------------------|------------------------------------------------------------------------------------|--------------------------------------------|-------------------------------------------------------------------------------|
|  | 32740 FourCast® 2 Four with Loop Armrests, Wooden shell | 4.4 | 10 |  | - | 4.365 |
|  | 32750 FourCast® 2 Four with Loop Armrests, Seat pad, wooden shell | 5.8 | 6 |  | 1 2 3 4 5 6 7 8 10 | 5.627 5.722 5.817 5.911 6.003 6.099 6.194 6.288 6.506 |

FourCast® 2 Four - Veneer

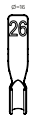
Design by Strand+Hvass

[Content ↗](#)

| ACCESSORIES | Description | Weight (Kg) | Dimensions (mm) | Price (SEK) |
|-------------------------------------------------------------------------------------|-------------------------------------------------------------------------------------------------------------------------------------|-------------|-----------------------------------------------------------------------|-------------|
| | CHAIR FEET Felt glides, set of 4 pcs. height + 0,2 cm | 1,82 g x 4 | | 208 |
|  | CHAIR FEET Set of 4 pcs. Noise reducing ferrule with big diameter (reduces pressure marks) Chair height + 0,8 cm | 4,8 g x 4 | | 276 |
|  | CHAIR FEET Noise reducing ferrule with felt, set of 4 pcs. Chair height + 1 cm | 6,6 g x 4 | | 276 |
| | CHAIR FEET Teflon glides, set of 4 pcs. Chair height + 0,2 cm | 2,75 g x 4 | | 208 |
|  | LINKING DEVICE Chair linking | 0,4 KG | C/C 535 mm C/C with armrest 585 mm C/C with Loop armrest 625 mm | 417 |
|  | GRIP HOLE Available for chairs without inside – and full upholstery | | | 189 |
|  | INNO Inno® Note in black, removable and foldable. Not available for chairs with Loop armrest and chairs with wooden legs. | 1,4 KG | 225 x 325 x 10 mm | 1.522 |
|  | SEAT ROW NUMBER - ACSR0101 16 mm - no.1 -25 | 29 g | | 1.579 |
|  | SEAT ROW NUMBER - ACSR0102 16 mm - no.26 -50 | 29 g | | 1.579 |
|  | INNO@NOTE TROLLEY - 20100007 Trolley for Inno® Note. Room for 51 Inno® Notes. | 58,5 Kg | 1532 x 662 x 1199 mm | 19.942 |
|  | CHAIR TROLLEY - 200X0 25 chairs without upholstery | 33,5 Kg | 1100 x 560 x 1970 mm | 8.859 |
|  | CHAIR TROLLEY - 200X0 20 chairs with seat pad or 18 chairs with full upholstery | 33,5 Kg | 1100 x 560 x 1910 / 1980 mm | 10.373 |
|  | SACK TROLLEY - 200X1 12 chairs without upholstery, 10 chairs with full upholstery | | | 4.918 |

FourCast® 2 Four - Veneer

Design by Strand+Hvass

[Content ↗](#)

| SURCHARGE | | Price (SEK) |
|-----------------------|------------------------------------------------------------------------------------------------------------|-------------|
| FRAME OPTIONAL |  7 A D E F M N O Q S T | 194 |
| |  P | 473 |

FourCast® 2 Line

Design by Strand+Hvass

[Content ↗](#)



FEATURES

- Armrest options
- Linking device optional on frames or under seat
- Monochrome powder coating on frames options
- Polyamide glides as standard
- Inno® Note tablet options
- Stackable on matching trolley
- Outdoor options
- We do not recommend suspensions for fully upholstered version



For product information visit oceefour.com ↗

SHELL COLOURS

Standard Polypropylene



FRAME COLOURS

Standard



Optional Polypropylene

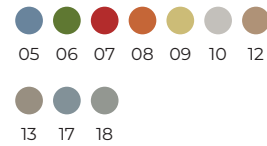

Frame optional*





For full colour details [go to page 236](#) ↗

| Product | Description (Item nr) | Weight (Kg) | Stacking on floor | Dimensions (mm) | Band | Standard PP (SEK) | Optional PP (SEK) |
|---------|------------------------------------------------------------------------|-------------|-------------------|-----------------|--------------------------------------------|-------------------------------------------------------------------------------|-------------------------------------------------------------------------------|
| | 33200 FourCast® 2 Line, Polypropylene shell | 5.7 | 12 | | - | 2.776 | 2.967 |
| | 33210 FourCast® 2 Line, Seat pad | 6.7 | 10 | | 1 2 3 4 5 6 7 8 10 | 4.038 4.133 4.228 4.322 4.414 4.510 4.605 4.699 4.917 | 4.229 4.324 4.419 4.513 4.605 4.701 4.796 4.890 5.108 |
| | 33230 FourCast® 2 Line, Fully upholstered | 5 | 8 | | 1 2 3 4 5 6 7 8 10 | 5.485 5.706 5.929 6.149 6.368 6.589 6.811 7.030 7.516 | |
| | 33300 FourCast® 2 Line with Armrests, Polypropylene shell | 6.5 | 12 | | - | 3.715 | 3.906 |

FourCast® 2 Line

Design by Strand+Hvass

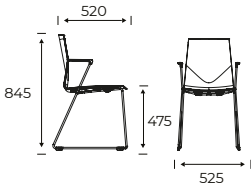







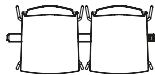

[Content ↗](#)

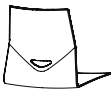
| Product | Description (Item nr) | Weight (Kg) | Stacking on floor | Dimensions (mm) | Band | Standard PP (SEK) | Optional PP (SEK) |
|-----------------------------------------------------------------------------------|-------------------------------------------------------------|-------------|----------------------|------------------------------------------------------------------------------------|-----------------------------------------------------------------------------------|----------------------------------------------------------------------|----------------------|
|  | 33310 FourCast® 2 Line with Armrests, Seat pad | 7.4 | 10 |  | 1 | 4.977 | 5.168 |
| | | | | | 2 | 5.072 | 5.263 |
| | | | | | 3 | 5.167 | 5.358 |
| | | | | | 4 | 5.261 | 5.452 |
| | | | | | 5 | 5.353 | 5.544 |
| | | | | | 6 | 5.449 | 5.640 |
| | | | | | 7 | 5.544 | 5.735 |
| | | | | | 8 | 5.638 | 5.829 |
| | | | | | 10 | 5.856 | 6.047 |
| | | | | |  | 33330 FourCast® 2 Line with Armrests, Fully upholstered | 5.8 |
| 2 | 6.645 | | | | | | |
| 3 | 6.868 | | | | | | |
| 4 | 7.088 | | | | | | |
| 5 | 7.307 | | | | | | |
| 6 | 7.528 | | | | | | |
| 7 | 7.750 | | | | | | |
| 8 | 7.969 | | | | | | |
| 10 | 8.455 | | | | | | |

FourCast® 2 Line

Design by Strand+Hvass

[Content ↗](#)

| ACCESSORIES | Description | Weight (Kg) | Dimensions (mm) | Price (SEK) |
|-------------------------------------------------------------------------------------|----------------------------------------------------------------------------------------------------------------------------------------|-------------|-----------------------------------------------------------------------|-------------|
| | CHAIR FEET Felt glides, set of 4 pcs. height + 0,2 cm | 1,82 g x 4 | | 208 |
| | CHAIR FEET Teflon glides, set of 4 pcs. Chair height + 0,2 cm | 2,75 g x 4 | | 208 |
|  | LINKING DEVICE Chair linking | 0,4 KG | C/C 535 mm C/C with armrest 585 mm C/C with Loop armrest 625 mm | 417 |
|  | LINKING DEVICE Chair linking | | C/C 540 mm C/C with armrest 540 mm | 390 |
|  | GRIP HOLE Available for chairs without inside - and full upholstery | | | 189 |
|  | INNO Inno® Note in black, removable and foldable. Not available for chairs with Loop armrest and chairs with wooden legs. | 1,4 KG | 225 x 325 x 10 mm | 1.522 |
|  | SEAT ROW NUMBER - ACSR0201 11 mm - no. 1 -25 | 29 g | | 1.579 |
|  | SEAT ROW NUMBER - ACSR0202 11 mm - no. 26 -50 | 29 g | | 1.579 |
|  | INNO@NOTE TROLLEY - 20100007 Trolley for Inno® Note. Room for 51 Inno® Notes. | 58,5 Kg | 1532 x 662 x 1199 mm | 19.942 |
|  | CHAIR TROLLEY - 200X0 30 chairs without upholstery | 33,5 Kg | 1100 x 560 x 1970 mm | 8.859 |
|  | CHAIR TROLLEY - 200X0 19 chairs with seat pad or 20 chairs with full upholstery | 33,5 Kg | 1100 x 560 x 1910 / 1980 mm | 10.373 |
|  | SACK TROLLEY - 200X1 12 chairs without upholstery, 10 chairs with full upholstery | | | 4.918 |

| SURCHARGE | | Price (SEK) |
|-----------------------|--------------------------------------------------------------------------------------------------------------|-------------|
| FRAME OPTIONAL |  7 A D E F M N O Q S T | 194 |

FourCast® 2 Line - Veneer

Design by Strand+Hvass

[Content ↗](#)



FEATURES

- Armrest options
- Linking device optional on frames or under seat
- Monochrome powder coating on frames options
- Polyamide glides as standard
- Inno® Note tablet options
- Stackable on matching trolley
- We do not recommend suspensions to black lacquered versions



For product information visit oceefour.com ↗

SHELL COLOURS

Veneer



FRAME COLOURS

Standard



Frame optional*











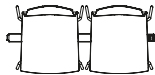

For full colour details [go to page 236](#) ↗

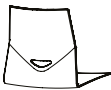
| Product | Description (Item nr) | Weight (Kg) | Stacking on floor | Dimensions (mm) | Band | Veneer (SEK) |
|---------|------------------------------------------------------------------------|-------------|-------------------|-----------------|--------------------------------------------|-------------------------------------------------------------------------------|
| | 33240 FourCast® 2 Line, Wooden shell | 4.3 | 12 | | - | 3.698 |
| | 33250 FourCast® 2 Line, Seat pad, wooden shell | 5.6 | 10 | | 1 2 3 4 5 6 7 8 10 | 4.960 5.055 5.150 5.244 5.336 5.432 5.527 5.621 5.839 |
| | 33340 FourCast® 2 Line with Armrests, Wooden shell | 5 | 8 | | - | 4.637 |
| | 33350 FourCast® 2 Line with Armrests, Seat pad, wooden shell | 6.4 | 10 | | 1 2 3 4 5 6 7 8 10 | 5.899 5.994 6.089 6.183 6.275 6.371 6.466 6.560 6.778 |

FourCast® 2 Line - Veneer

Design by Strand+Hvass

[Content ↗](#)

| ACCESSORIES | Description | Weight (Kg) | Dimensions (mm) | Price (SEK) |
|-------------------------------------------------------------------------------------|----------------------------------------------------------------------------------------------------------------------------------------|-------------|-----------------------------------------------------------------------|-------------|
| | CHAIR FEET Felt glides, set of 4 pcs. height + 0,2 cm | 1,82 g x 4 | | 208 |
| | CHAIR FEET Teflon glides, set of 4 pcs. Chair height + 0,2 cm | 2,75 g x 4 | | 208 |
|  | LINKING DEVICE Chair linking | 0,4 KG | C/C 535 mm C/C with armrest 585 mm C/C with Loop armrest 625 mm | 417 |
|  | LINKING DEVICE Chair linking | | C/C 540 mm C/C with armrest 540 mm | 390 |
|  | GRIP HOLE Available for chairs without inside - and full upholstery | | | 189 |
|  | INNO Inno® Note in black, removable and foldable. Not available for chairs with Loop armrest and chairs with wooden legs. | 1,4 KG | 225 x 325 x 10 mm | 1.522 |
|  | SEAT ROW NUMBER - ACSR0201 11 mm - no. 1 -25 | 29 g | | 1.579 |
|  | SEAT ROW NUMBER - ACSR0202 11 mm - no. 26 -50 | 29 g | | 1.579 |
|  | INNO@NOTE TROLLEY - 20100007 Trolley for Inno® Note. Room for 51 Inno® Notes. | 58,5 Kg | 1532 x 662 x 1199 mm | 19.942 |
|  | CHAIR TROLLEY - 200X0 30 chairs without upholstery | 33,5 Kg | 1100 x 560 x 1970 mm | 8.859 |
|  | CHAIR TROLLEY - 200X0 19 chairs with seat pad or 20 chairs with full upholstery | 33,5 Kg | 1100 x 560 x 1910 / 1980 mm | 10.373 |
|  | SACK TROLLEY - 200X1 12 chairs without upholstery, 10 chairs with full upholstery | | | 4.918 |

| SURCHARGE | | Price (SEK) |
|-----------------------|--------------------------------------------------------------------------------------------------------------|-------------|
| FRAME OPTIONAL |  7 A D E F M N O Q S T | 194 |

FourCast® 2 Counter

Design by Strand+Hvass

[Content ↗](#)



FEATURES

- Fits table height 90 cm
- Stackable on floor
- Polyamide glides as standard
- Monochrome powder coating on frames options
- Outdoor options
- We do not recommend suspensions to fully upholstered version



For product information visit oceefour.com ↗

SHELL COLOURS

Standard Polypropylene



Optional Polypropylene

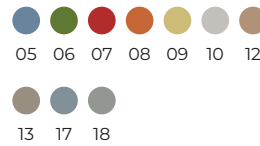

FRAME COLOURS

Standard



Frame optional*



For full colour details [go to page 236](#) ↗

| Product | Description (Item nr) | Weight (Kg) | Stacking on floor | Dimensions (mm) | Band | Standard PP (SEK) | Optional PP (SEK) |
|---------|----------------------------------------------------------|-------------|-------------------|-----------------|--------------------------------------------|-------------------------------------------------------------------------------|-------------------------------------------------------------------------------|
| | 33800 FourCast® 2 Counter, Polypropylene shell | 6.6 | 4 | | - | 3.730 | 3.921 |
| | 33810 FourCast® 2 Counter, Seat pad | 7.5 | 4 | | 1 2 3 4 5 6 7 8 10 | 4.992 5.087 5.182 5.276 5.368 5.464 5.559 5.653 5.871 | 5.183 5.278 5.373 5.467 5.559 5.655 5.750 5.844 6.062 |
| | 33830 FourCast® 2 Counter, Fully upholstered | 7.1 | 4 | | 1 2 3 4 5 6 7 8 10 | 6.439 6.660 6.883 7.103 7.322 7.543 7.765 7.984 8.470 | |

FourCast® 2 Counter

Design by Strand+Hvass

[Content ↗](#)

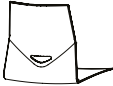
| ACCESSORIES | Description | Weight (Kg) | Dimensions (mm) | Price (SEK) |
|-----------------------------------------------------------------------------------|-------------------------------------------------------------------------------|-------------|-----------------|-------------|
| | CHAIR FEET Felt glides, set of 4 pcs. height + 0,2 cm | 1,82 g x 4 | | 208 |
| | CHAIR FEET Teflon glides, set of 4 pcs. Chair height + 0,2 cm | 2,75 g x 4 | | 208 |
|  | GRIP HOLE Available for chairs without inside – and full upholstery | | | 189 |

| SURCHARGE | | Price (SEK) |
|-----------------------|------------------------------------------------------------------------------------------------------------|-------------|
| FRAME OPTIONAL |  7 A D E F M N O Q S T | 194 |

FourCast® 2 Counter - Veneer

Design by Strand+Hvass

[Content](#) ↗



FEATURES

- Fits table height 90 cm
- Stackable on floor
- Polyamide glides as standard
- Monochrome powder coating on frames options
- We do not recommend suspensions to black lacquered versions

For product information visit oceefour.com ↗

SHELL COLOURS

Veneer



FRAME COLOURS

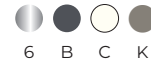

Standard



Frame optional*

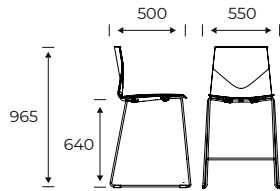

For full colour details [go to page 236](#) ↗

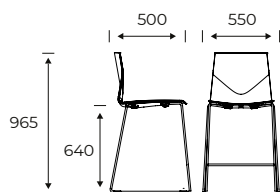
| Product | Description (Item nr) | Weight (Kg) | Stacking on floor | Dimensions (mm) | Band | Veneer (SEK) |
|-------------------------------------------------------------------------------------|-------------------------------------------------------------|-------------|-------------------|--------------------------------------------------------------------------------------|--------------------------------------------|-------------------------------------------------------------------------------|
|  | 33840 FourCast® 2 Counter, Wooden shell | 7.2 | 4 |  | - | 4.652 |
|  | 33850 FourCast® 2 Counter, Seat pad, wooden shell | 8.6 | 4 |  | 1 2 3 4 5 6 7 8 10 | 5.914 6.009 6.104 6.198 6.290 6.386 6.481 6.575 6.793 |

| ACCESSORIES | Description | Weight (Kg) | Dimensions (mm) | Price (SEK) |
|-------------------------------------------------------------------------------------|-------------------------------------------------------------------------------|-------------|-----------------|-------------|
| | CHAIR FEET Felt glides, set of 4 pcs. height + 0,2 cm | 1,82 g x 4 | | 208 |
| | CHAIR FEET Teflon glides, set of 4 pcs. Chair height + 0,2 cm | 2,75 g x 4 | | 208 |
|  | GRIP HOLE Available for chairs without inside - and full upholstery | | | 189 |

FourCast® 2 Counter - Veneer

Design by Strand+Hvass

[Content ↗](#)

| SURCHARGE | | Price (SEK) |
|----------------|------------------------------------------------------------------------------------------------------------|-------------|
| FRAME OPTIONAL |  7 A D E F M N O Q S T | 194 |

FourCast® 2 High

Design by Strand+Hvass

[Content ↗](#)



FEATURES

- Fits table height 105 cm
- Stackable on floor
- Polyamide glides as standard
- Monochrome powder coating on frames options
- Outdoor options
- We do not recommend suspensions to fully upholstered version



For product information visit oceefour.com ↗

SHELL COLOURS

Standard Polypropylene



Optional Polypropylene

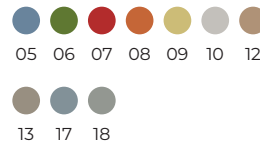

FRAME COLOURS

Standard



Frame optional*





For full colour details [go to page 236](#) ↗

| Product | Description (Item nr) | Weight (Kg) | Stacking on floor | Dimensions (mm) | Band | Standard PP (SEK) | Optional PP (SEK) |
|---------|-------------------------------------------------------|-------------|-------------------|-----------------|--------------------------------------------|-------------------------------------------------------------------------------|-------------------------------------------------------------------------------|
| | 33900 FourCast® 2 High, Polypropylene shell | 7.3 | 4 | | - | 3.815 | 4.006 |
| | 33910 FourCast® 2 High, Seat pad | 8.3 | 4 | | 1 2 3 4 5 6 7 8 10 | 5.077 5.172 5.267 5.361 5.453 5.549 5.644 5.738 5.956 | 5.268 5.363 5.458 5.552 5.644 5.740 5.835 5.929 6.147 |
| | 33930 FourCast® 2 High, Fully upholstered | 7.8 | 4 | | 1 2 3 4 5 6 7 8 10 | 6.524 6.745 6.968 7.188 7.407 7.628 7.850 8.069 8.555 | |

FourCast® 2 High

Design by Strand+Hvass

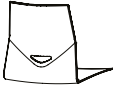
[Content ↗](#)

| ACCESSORIES | Description | Weight (Kg) | Dimensions (mm) | Price (SEK) |
|-----------------------------------------------------------------------------------|------------------------------------------------------------------------------------------------------------|-------------|-----------------|-------------|
| | CHAIR FEET Felt glides, set of 4 pcs. height + 0,2 cm | 1,82 g x 4 | | 208 |
| | CHAIR FEET Teflon glides, set of 4 pcs. Chair height + 0,2 cm | 2,75 g x 4 | | 208 |
|  | GRIP HOLE Available for chairs without inside – and full upholstery | | | 189 |
| SURCHARGE | | | | Price (SEK) |
| FRAME OPTIONAL |  7 A D E F M N O Q S T | | | 194 |

FourCast® 2 High - Veneer

Design by Strand+Hvass

[Content ↗](#)



FEATURES

- Fits table height 105 cm
- Stackable on floor
- Polyamide glides as standard
- Monochrome powder coating on frames options
- We do not recommend suspensions to black lacquered versions



For product information visit oceefour.com ↗

SHELL COLOURS

Veneer



FRAME COLOURS

Standard



Frame optional*



For full colour details [go to page 236](#) ↗

| Product | Description (Item nr) | Weight (Kg) | Stacking on floor | Dimensions (mm) | Band | Veneer (SEK) |
|---------|----------------------------------------------------------|-------------|-------------------|-----------------|--------------------------------------------|-------------------------------------------------------------------------------|
| | 33940 FourCast® 2 High, Wooden shell | 8 | 4 | | - | 4.737 |
| | 33950 FourCast® 2 High, Seat pad, wooden shell | 9.4 | 4 | | 1 2 3 4 5 6 7 8 10 | 5.999 6.094 6.189 6.283 6.375 6.471 6.566 6.660 6.878 |

| ACCESSORIES | Description | Weight (Kg) | Dimensions (mm) | Price (SEK) |
|-------------|-------------------------------------------------------------------------------|-------------|-----------------|-------------|
| | CHAIR FEET Felt glides, set of 4 pcs. height + 0,2 cm | 1,82 g x 4 | | 208 |
| | CHAIR FEET Teflon glides, set of 4 pcs. Chair height + 0,2 cm | 2,75 g x 4 | | 208 |
| | GRIP HOLE Available for chairs without inside - and full upholstery | | | 189 |

FourCast® 2 High - Veneer

Design by Strand+Hvass

[Content ↗](#)

| SURCHARGE | | Price (SEK) |
|----------------|------------------------------------------------------------------------------------------------------------|-------------|
| FRAME OPTIONAL |  7 A D E F M N O Q S T | 194 |

FourCast® 2 Counter Four

Design by Strand+Hvass

[Content ↗](#)



FEATURES

- Fits table height 90 cm
- Stackable on floor
- Polyamide glides as standard
- Monochrome powder coating on frames options
- We do not recommend suspensions to fully upholstered version



For product information visit oceefour.com ↗

SHELL COLOURS

Standard Polypropylene



FRAME COLOURS

Standard



Optional Polypropylene

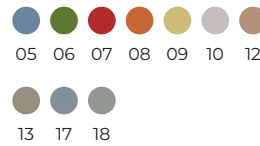

Frame optional*



For full colour details [go to page 236](#) ↗

| Product | Description (Item nr) | Weight (Kg) | Stacking on floor | Dimensions (mm) | Band | Standard PP (SEK) | Optional PP (SEK) |
|---------|------------------------------------------------------------------|-------------|-------------------|-----------------|--------------------------------------------|-------------------------------------------------------------------------------|-------------------------------------------------------------------------------|
| | 34000 FourCast® 2 Counter Four, Polypropylene shell | 7.7 | 4 | | - | 3.492 | 3.683 |
| | 34010 FourCast® 2 Counter Four, Seat pad | 8.6 | 4 | | 1 2 3 4 5 6 7 8 10 | 4.754 4.849 4.944 5.038 5.130 5.226 5.321 5.415 5.633 | 4.945 5.040 5.135 5.229 5.321 5.417 5.512 5.606 5.824 |
| | 34030 FourCast® 2 Counter Four, Fully upholstered | 8.2 | 4 | | 1 2 3 4 5 6 7 8 10 | 6.201 6.422 6.645 6.865 7.084 7.305 7.527 7.746 8.232 | |

FourCast® 2 Counter Four

Design by Strand+Hvass

[Content ↗](#)

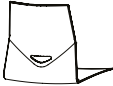
| ACCESSORIES | Description | Weight (Kg) | Dimensions (mm) | Price (SEK) |
|-----------------------------------------------------------------------------------|-------------------------------------------------------------------------------|-------------|-----------------|-------------|
| | CHAIR FEET Felt glides, set of 4 pcs. height + 0,2 cm | 1,82 g x 4 | | 208 |
| | CHAIR FEET Teflon glides, set of 4 pcs. Chair height + 0,2 cm | 2,75 g x 4 | | 208 |
|  | GRIP HOLE Available for chairs without inside – and full upholstery | | | 189 |

| SURCHARGE | | Price (SEK) |
|-----------------------|------------------------------------------------------------------------------------------------------------|-------------|
| FRAME OPTIONAL |  7 A D E F M N O Q S T | 194 |

FourCast® 2 Counter Four - Veneer

Design by Strand+Hvass

[Content](#) ↗



FEATURES

- Fits table height 90 cm
- Stackable on floor
- Polyamide glides as standard
- Monochrome powder coating on frames options
- We do not recommend suspensions to black lacquered versions



For product information visit oceefour.com ↗

SHELL COLOURS

Veneer



FRAME COLOURS

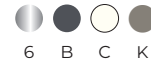

Standard



Frame optional*

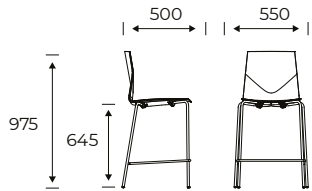

For full colour details [go to page 236](#) ↗

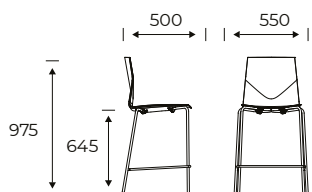
| Product | Description (Item nr) | Weight (Kg) | Stacking on floor | Dimensions (mm) | Band | Veneer (SEK) |
|-------------------------------------------------------------------------------------|---------------------------------------------------------------------|-------------|-------------------|--------------------------------------------------------------------------------------|--------------------------------------------|-------------------------------------------------------------------------------|
|  | 34040 FourCast® 2 Counter Four, Wooden shell | 8.3 | 4 |  | - | 4.414 |
|  | 34050 FourCast® 2 Counter Four, Seat pad, wooden shell | 9.7 | 4 |  | 1 2 3 4 5 6 7 8 10 | 5.676 5.771 5.866 5.960 6.052 6.148 6.243 6.337 6.555 |

| ACCESSORIES | Description | Weight (Kg) | Dimensions (mm) | Price (SEK) |
|-------------------------------------------------------------------------------------|-------------------------------------------------------------------------------|-------------|-----------------|-------------|
| | CHAIR FEET Felt glides, set of 4 pcs. height + 0,2 cm | 1,82 g x 4 | | 208 |
| | CHAIR FEET Teflon glides, set of 4 pcs. Chair height + 0,2 cm | 2,75 g x 4 | | 208 |
|  | GRIP HOLE Available for chairs without inside - and full upholstery | | | 189 |

FourCast® 2 Counter Four - Veneer

Design by Strand+Hvass

[Content ↗](#)

| SURCHARGE | | Price (SEK) |
|----------------|------------------------------------------------------------------------------------------------------------|-------------|
| FRAME OPTIONAL |  7 A D E F M N O Q S T | 194 |

FourCast® 2 High Four

Design by Strand+Hvass

[Content](#) ↗



FEATURES

- Fits table height 105 cm
- Stackable on floor
- Polyamide glides as standard
- Monochrome powder coating on frames options
- We do not recommend suspensions to fully upholstered version



For product information visit oceefour.com ↗

SHELL COLOURS

Standard Polypropylene



FRAME COLOURS

Standard



Optional Polypropylene

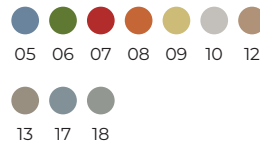

Frame optional*





For full colour details [go to page 236](#) ↗

| Product | Description (Item nr) | Weight (Kg) | Stacking on floor | Dimensions (mm) | Band | Standard PP (SEK) | Optional PP (SEK) |
|---------|------------------------------------------------------------|-------------|-------------------|-----------------|--------------------------------------------|-------------------------------------------------------------------------------|-------------------------------------------------------------------------------|
| | 34100 FourCast® 2 High Four, Polypropylene shell | 6.7 | 4 | | - | 3.492 | 3.683 |
| | 34110 FourCast® 2 High Four, Seat pad | 7.7 | 4 | | 1 2 3 4 5 6 7 8 10 | 4.754 4.849 4.944 5.038 5.130 5.226 5.321 5.415 5.633 | 4.945 5.040 5.135 5.229 5.321 5.417 5.512 5.606 5.824 |
| | 34130 FourCast® 2 High Four, Fully upholstered | 7.2 | 4 | | 1 2 3 4 5 6 7 8 10 | 6.201 6.422 6.645 6.865 7.084 7.305 7.527 7.746 8.232 | |

FourCast® 2 High Four

Design by Strand+Hvass

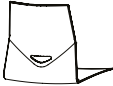
[Content ↗](#)

| ACCESSORIES | Description | Weight (Kg) | Dimensions (mm) | Price (SEK) |
|-----------------------------------------------------------------------------------|------------------------------------------------------------------------------------------------------------|-------------|-----------------|-------------|
| | CHAIR FEET Felt glides, set of 4 pcs. height + 0,2 cm | 1,82 g x 4 | | 208 |
| | CHAIR FEET Teflon glides, set of 4 pcs. Chair height + 0,2 cm | 2,75 g x 4 | | 208 |
|  | GRIP HOLE Available for chairs without inside – and full upholstery | | | 189 |
| SURCHARGE | | | | Price (SEK) |
| FRAME OPTIONAL |  7 A D E F M N O Q S T | | | 194 |

FourCast® 2 High Four - Veneer

Design by Strand+Hvass

[Content](#) ↗



FEATURES

- Fits table height 105 cm
- Stackable on floor
- Polyamide glides as standard
- Monochrome powder coating on frames options
- We do not recommend suspensions to black lacquered versions

For product information visit oceefour.com ↗

SHELL COLOURS

Veneer



FRAME COLOURS

Standard



Frame optional*



For full colour details [go to page 236](#) ↗

| Product | Description (Item nr) | Weight (Kg) | Stacking on floor | Dimensions (mm) | Band | Veneer (SEK) |
|---------|---------------------------------------------------------------|-------------|-------------------|-----------------|--------------------------------------------|-------------------------------------------------------------------------------|
| | 34140 FourCast® 2 High Four, Wooden shell | 7.4 | 4 | | - | 4.414 |
| | 34150 FourCast® 2 High Four, Seat pad, wooden shell | 8.8 | 4 | | 1 2 3 4 5 6 7 8 10 | 5.676 5.771 5.866 5.960 6.052 6.148 6.243 6.337 6.555 |

| ACCESSORIES | Description | Weight (Kg) | Dimensions (mm) | Price (SEK) |
|-------------|-------------------------------------------------------------------------------|-------------|-----------------|-------------|
| | CHAIR FEET Felt glides, set of 4 pcs. height + 0,2 cm | 1,82 g x 4 | | 208 |
| | CHAIR FEET Teflon glides, set of 4 pcs. Chair height + 0,2 cm | 2,75 g x 4 | | 208 |
| | GRIP HOLE Available for chairs without inside - and full upholstery | | | 189 |

FourCast® 2 High Four - Veneer

Design by Strand+Hvass

[Content ↗](#)

| SURCHARGE | | Price (SEK) |
|----------------|----------------------------------------------------------------------------------------------------------------|-------------|
| FRAME OPTIONAL |  <p>7 A D E F M N O Q S T</p> | 194 |

FourCast® 2 Wheeler

Design by Strand+Hvass

[Content ↗](#)



FEATURES

- Inno® Tab, flexible and rotating writing tablet options
- Gas lift, 41 - 57,5 cm
- Free Float options
- Black base with castors as standard
- Aluminium base options
- We do not recommend suspensions to fully upholstered version



For product information visit oceefour.com ↗

SHELL COLOURS

Standard Polypropylene



Optional Polypropylene

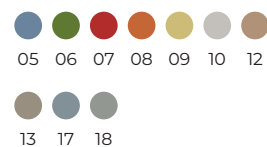

FRAME COLOURS

Standard



Frame optional*









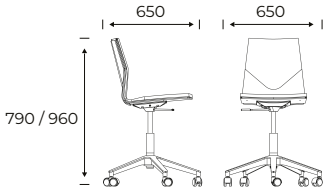

For full colour details [go to page 236](#) ↗

| Product | Description (Item nr) | Weight (Kg) | Dimensions (mm) | Band | Standard PP (SEK) | Optional PP (SEK) |
|---------|---------------------------------------------------------------------------------|-------------|-----------------|--------------------------------------------|-------------------------------------------------------------------------------|-------------------------------------------------------------------------------|
| | 35004 FourCast® 2 Wheeler, Polypropylene shell, Without tilt with gas | 7.3 | | - | 3.016 | 3.207 |
| | 35014 FourCast® 2 Wheeler, Seat pad, Without tilt with gas | 7.9 | | 1 2 3 4 5 6 7 8 10 | 4.278 4.373 4.468 4.562 4.654 4.750 4.845 4.939 5.157 | 4.469 4.564 4.659 4.753 4.845 4.941 5.036 5.130 5.348 |
| | 35034 FourCast® 2 Wheeler, Fully upholstered, Without tilt with gas | 6.2 | | 1 2 3 4 5 6 7 8 10 | 5.725 5.946 6.169 6.389 6.608 6.829 7.051 7.270 7.756 | |
| | 35005 FourCast® 2 Wheeler, Polypropylene shell, With tilt with gas | 7.3 | | - | 3.380 | 3.571 |

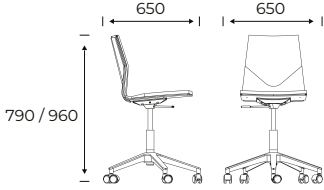
FourCast® 2 Wheeler

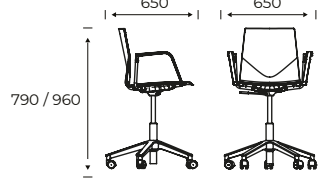
Design by Strand+Hvass

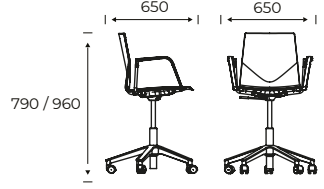

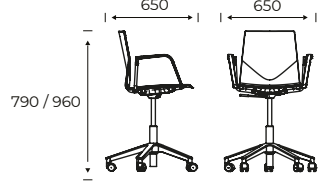

[Content ↗](#)

| Product | Description (Item nr) | Weight (Kg) | Dimensions (mm) | Band | Standard PP (SEK) | Optional PP (SEK) |
|------------------------------------------------------------------------------------|-------------------------------------------------------------------------------------------------|-------------|--------------------------------------------------------------------------------------|--------------------------------------------|-------------------------------------------------------------------------------|-------------------------------------------------------------------------------|
|  | 35015 FourCast@ 2 Wheeler, Seat pad, With tilt with gas | 7.9 |  | 1 2 3 4 5 6 7 8 10 | 4.642 4.737 4.832 4.926 5.018 5.114 5.209 5.303 5.521 | 4.833 4.928 5.023 5.117 5.209 5.305 5.400 5.494 5.712 |
|  | 35035 FourCast@ 2 Wheeler, Fully upholstered, With tilt with gas | 6.2 |  | 1 2 3 4 5 6 7 8 10 | 6.089 6.310 6.533 6.753 6.972 7.193 7.415 7.634 8.120 | |
|  | 34905 FourCast@ 2 Wheeler with Loop Armrests, Polypropylene shell, With tilt with gas | 8.5 |  | - | 4.524 | 4.715 |
|  | 34915 FourCast@ 2 Wheeler with Loop Armrests, Seat pad, With tilt with gas | 9.1 |  | 1 2 3 4 5 6 7 8 10 | 5.786 5.881 5.976 6.070 6.162 6.258 6.353 6.447 6.665 | 5.977 6.072 6.167 6.261 6.353 6.449 6.544 6.638 6.856 |
|  | 34935 FourCast@ 2 Wheeler with Loop Armrests, Fully upholstered, With tilt with gas | 7.4 |  | 1 2 3 4 5 6 7 8 10 | 7.233 7.454 7.677 7.897 8.116 8.337 8.559 8.778 9.264 | |

FourCast® 2 Wheeler

Design by Strand+Hvass

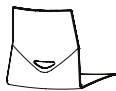
[Content ↗](#)

| ACCESSORIES | Description | Weight (Kg) | Dimensions (mm) | Price (SEK) |
|-------------------------------------------------------------------------------------|-----------------------------------------------------------------------------------------------------------|-------------|-------------------|-------------|
|  | HOOK Hook in black | | | 47 |
|  | CHAIR FEET Standard polymide glides. Chair height + 0,2 cm | | | |
| | CHAIR FEET Castor with breaks, hard | | | 599 |
|  | FOOTRING Gas lift including footring Spand 41 cm. - 57,5 cm. | | 585 - 845 mm | 1.368 |
|  | GRIP HOLE Available for chairs without inside - and full upholstery | | | 189 |
| | With GS certification | | | 1.489 |
|  | INNO Foldable Inno® Tab in black with integrated cup holder and dashboard for tablet and phone. | 2,7 KG | 520 x 320 x 23 mm | 2.125 |
| SURCHARGE | | | | Price (SEK) |
| FRAME OPTIONAL |  4 | | | 643 |

FourCast® 2 77

Design by Strand+Hvass

[Content ↗](#)



FEATURES

- Armrest options
- Stackable on floor
- Monochrome powder coating on frames options
- We do not recommend suspensions for fully upholstered version



For product information visit oceefour.com ↗

SHELL COLOURS

Standard Polypropylene



FRAME COLOURS

Standard



Optional Polypropylene

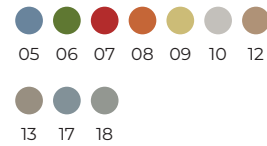

Frame optional*





For full colour details [go to page 236](#) ↗

| Product | Description (Item nr) | Weight (Kg) | Stacking on floor | Dimensions (mm) | Band | Standard PP (SEK) | Optional PP (SEK) |
|---------|-------------------------------------------------------------------|-------------|-------------------|-----------------|--------------------------------------------|-------------------------------------------------------------------------------|-------------------------------------------------------------------------------|
| | 32800 FourCast® 2 77, Polypropylene shell | 5.8 | 7 | | - | 2.734 | 2.925 |
| | 32810 FourCast® 2 77, Seat pad | 6.8 | 5 | | 1 2 3 4 5 6 7 8 10 | 3.996 4.091 4.186 4.280 4.372 4.468 4.563 4.657 4.875 | 4.187 4.282 4.377 4.471 4.563 4.659 4.754 4.848 5.066 |
| | 32830 FourCast® 2 77, Fully upholstered | 5.1 | 5 | | 1 2 3 4 5 6 7 8 10 | 5.443 5.664 5.887 6.107 6.326 6.547 6.769 6.988 7.474 | |
| | 32900 FourCast® 2 77 with Armrests, Polypropylene shell | 6.4 | 7 | | - | 3.888 | 4.079 |

FourCast® 2 77

Design by Strand+Hvass

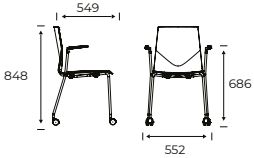
[Content ↗](#)

| Product | Description (Item nr) | Weight (Kg) | Stacking on floor | Dimensions (mm) | Band | Standard PP (SEK) | Optional PP (SEK) |
|-----------------------------------------------------------------------------------|--------------------------------------------------------|-------------|-------------------|------------------------------------------------------------------------------------|-----------------------------------------------------------------------------------|-----------------------------------------------------------------|-------------------|
|  | 32910 FourCast® 2 77 with Armrests, Seat pad | 7.4 | 5 |  | 1 | 5.150 | 5.341 |
| | | | | | 2 | 5.245 | 5.436 |
| | | | | | 3 | 5.340 | 5.531 |
| | | | | | 4 | 5.434 | 5.625 |
| | | | | | 5 | 5.526 | 5.717 |
| | | | | | 6 | 5.622 | 5.813 |
| | | | | | 7 | 5.717 | 5.908 |
| | | | | | 8 | 5.811 | 6.002 |
| | | | | | 10 | 6.029 | 6.220 |
| | | | | |  | 32930 FourCast® 2 77 with Armrests, Fully upholstered | 5.8 |
| 2 | 6.818 | | | | | | |
| 3 | 7.041 | | | | | | |
| 4 | 7.261 | | | | | | |
| 5 | 7.480 | | | | | | |
| 6 | 7.701 | | | | | | |
| 7 | 7.923 | | | | | | |
| 8 | 8.142 | | | | | | |
| 10 | 8.628 | | | | | | |

| ACCESSORIES | Description | Weight (Kg) | Dimensions (mm) | Price (SEK) |
|-----------------------------------------------------------------------------------|-------------------------------------------------------------------------------|-------------|-----------------|-------------|
|  | GRIP HOLE Available for chairs without inside – and full upholstery | | | 189 |

| SURCHARGE | | Price (SEK) |
|-----------------------|--------------------------------------------------------------------------------------------------------------|-------------|
| FRAME OPTIONAL |  7 A D E F M N O Q S T | 194 |

FourCast® 2 77 - Veneer

Design by Strand+Hvass

[Content ↗](#)



FEATURES

- Armrest options
- Stackable on floor
- Monochrome powder coating on frames options
- We do not recommend suspensions to black lacquered versions



For product information visit oceefour.com ↗

SHELL COLOURS

Veneer



FRAME COLOURS







Standard

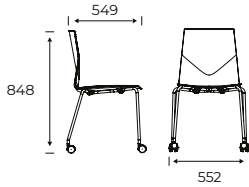

Frame optional*

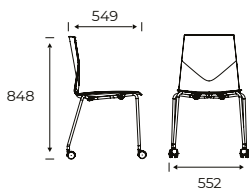

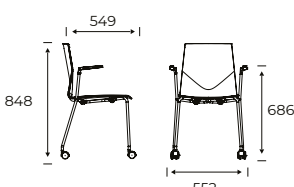

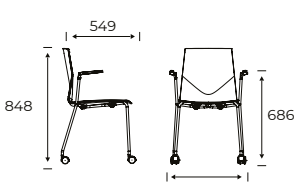
For full colour details [go to page 236](#) ↗

| Product | Description (Item nr) | Weight (Kg) | Stacking on floor | Dimensions (mm) | Band | Veneer (SEK) |
|------------------------------------------------------------------------------------|----------------------------------------------------------------------|-------------|-------------------|--------------------------------------------------------------------------------------|--------------------------------------------|-------------------------------------------------------------------------------|
|  | 32840 FourCast® 2 77, Wooden shell | 4.4 | - |  | - | 3.656 |
|  | 32850 FourCast® 2 77, Seat pad, wooden shell | 5.8 | 5 |  | 1 2 3 4 5 6 7 8 10 | 4.918 5.013 5.108 5.202 5.294 5.390 5.485 5.579 5.797 |
|  | 32940 FourCast® 2 77 with Armrests, Wooden shell | 5 | 7 |  | - | 4.810 |
|  | 32950 FourCast® 2 77 with Armrests, Seat pad, wooden shell | 6.4 | 5 |  | 1 2 3 4 5 6 7 8 10 | 6.072 6.167 6.262 6.356 6.448 6.544 6.639 6.733 6.951 |

FourCast® 2 77 - Veneer

[Content ↗](#)

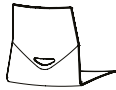
Design by Strand+Hvass

| ACCESSORIES | Description | Weight (Kg) | Dimensions (mm) | Price (SEK) |
|-----------------------------------------------------------------------------------|------------------------------------------------------------------------------------------------------------|-------------|-----------------|-------------|
|  | GRIP HOLE Available for chairs without inside – and full upholstery | | | 189 |
| SURCHARGE | | | | Price (SEK) |
| FRAME OPTIONAL |  7 A D E F M N O Q S T | | | 194 |

FourCast® 2 One

Design by Strand+Hvass

[Content ↗](#)



FEATURES

- Armrest options
- Swivel with freefloat in seat/back
- Return mechanism options
- Polyamide glides as standard
- Teflon or felt glides options
- Soft castor options (fixed cone without swivel and return)
- Monochrome powder coating on frames options
- We do not recommend suspensions to fully upholstered version



For product information visit oceefour.com ↗

SHELL COLOURS

Standard Polypropylene



FRAME COLOURS

Standard



Optional Polypropylene

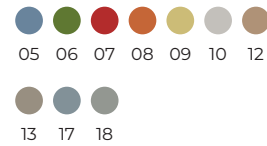











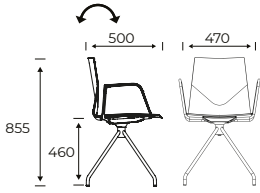

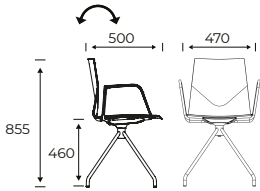

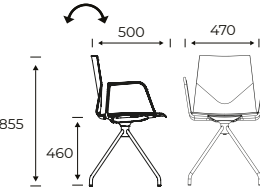
For full colour details [go to page 236](#) ↗

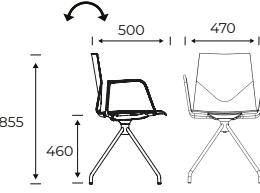

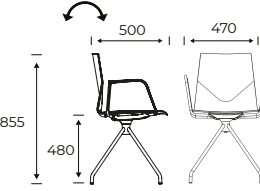
| Product | Description (Item nr) | Weight (Kg) | Dimensions (mm) | Band | Standard PP (SEK) | Optional PP (SEK) |
|---------|-----------------------------------------------------------------------------|-------------|-----------------|--------------------------------------------|-------------------------------------------------------------------------------|-------------------------------------------------------------------------------|
| | 33001 FourCast® 2 One, Polypropylene shell, With tilt | 6.2 | | - | 3.798 | 3.989 |
| | 33003 FourCast® 2 One, Polypropylene shell, With tilt with return | - | | - | 4.971 | 5.162 |
| | 33011 FourCast® 2 One, Seat pad, With tilt | 6.8 | | 1 2 3 4 5 6 7 8 10 | 5.060 5.155 5.250 5.344 5.436 5.532 5.627 5.721 5.939 | 5.251 5.346 5.441 5.535 5.627 5.723 5.818 5.912 6.130 |
| | 33013 FourCast® 2 One, Seat pad, With tilt with return | 7 | | 1 2 3 4 5 6 7 8 10 | 6.233 6.328 6.423 6.517 6.609 6.705 6.800 6.894 7.112 | 6.424 6.519 6.614 6.708 6.800 6.896 6.991 7.085 7.303 |

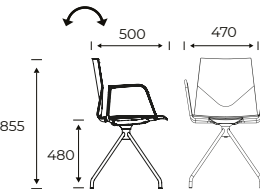
FourCast® 2 One

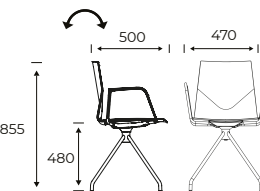
Design by Strand+Hvass

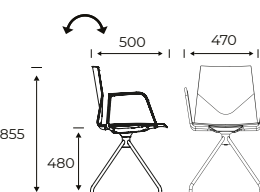
[Content ↗](#)

| Product | Description (Item nr) | Weight (Kg) | Dimensions (mm) | Band | Standard PP (SEK) | Optional PP (SEK) |
|-------------------------------------------------------------------------------------|------------------------------------------------------------------------------------------------|-------------|--------------------------------------------------------------------------------------|--------------------------------------------|----------------------------------------------------------------------------------|-------------------------------------------------------------------------------|
|  | 33031 FourCast® 2 One, Fully upholstered, With tilt | 5.1 |  | 1 2 3 4 5 6 7 8 10 | 6.507 6.728 6.951 7.171 7.390 7.611 7.833 8.052 8.538 | |
|  | 33033 FourCast® 2 One, Fully upholstered, With tilt with return | 5.3 |  | 1 2 3 4 5 6 7 8 10 | 7.680 7.901 8.124 8.344 8.563 8.784 9.006 9.225 9.711 | |
|  | 33101 FourCast® 2 One with Loop Armrests, Polypropylene shell, With tilt | 7.6 |  | - | 4.951 | 5.142 |
|  | 33103 FourCast® 2 One with Loop Armrests, Polypropylene shell, With tilt with return | - |  | - | 6.124 | 6.315 |
|  | 33111 FourCast® 2 One with Loop Armrests, Seat pad, With tilt | 7.9 |  | 1 2 3 4 5 6 7 8 10 | 6.213 6.308 6.403 6.497 6.589 6.685 6.780 6.874 7.092 | 6.404 6.499 6.594 6.688 6.780 6.876 6.971 7.065 7.283 |
|  | 33113 FourCast® 2 One with Loop Armrests, Seat pad, With tilt with return | 8.2 |  | 1 2 3 4 5 6 7 8 10 | 7.386 7.481 7.576 7.670 7.762 7.858 7.953 8.047 8.265 | 7.577 7.672 7.767 7.861 7.953 8.049 8.144 8.238 8.456 |
|  | 33131 FourCast® 2 One with Loop Armrests, Fully upholstered, With tilt | 6.3 |  | 1 2 3 4 5 6 7 8 10 | 7.660 7.881 8.104 8.324 8.543 8.764 8.986 9.205 9.691 | |
|  | 33133 FourCast® 2 One with Loop Armrests, Fully upholstered, With tilt with return | 6.5 |  | 1 2 3 4 5 6 7 8 10 | 8.833 9.054 9.277 9.497 9.716 9.937 10.159 10.378 10.864 | |

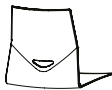
| ACCESSORIES | Description | Weight (Kg) | Dimensions (mm) | Price (SEK) |
|------------------------------------------------------------------------------------|-----------------------------------------------------------------------------------------------------------------------------|-------------|-----------------|-------------|
| | CHAIR FEET Castors | | | 876 |
| | CHAIR FEET Felt glides, set of 4 pcs. height + 0,2 cm | 1,82 g x 4 | | 208 |
|  | CHAIR FEET Set of 4 pcs. Noise reducing ferrule with big diameter (reduces pressure marks) Chair height + 0,8 cm | 4,8 g x 4 | | 276 |
|  | CHAIR FEET Noise reducing ferrule with felt, set of 4 pcs. Chair height + 1 cm | 6,6 g x 4 | | 276 |
| | CHAIR FEET Teflon glides, set of 4 pcs. Chair height + 0,2 cm | 2,75 g x 4 | | 208 |
|  | GRIP HOLE Available for chairs without inside – and full upholstery | | | 189 |

FourCast® 2 One - Veneer

Design by Strand+Hvass

[Content ↗](#)



FEATURES

- Armrest options
- Swivel with freefloat in seat/back
- Return mechanism options
- Polyamide glides as standard
- Teflon or felt glides and soft castor options
- We do not recommend suspensions to black lacquered versions



For product information visit oceefour.com ↗

SHELL COLOURS

Veneer







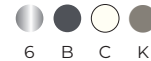

FRAME COLOURS

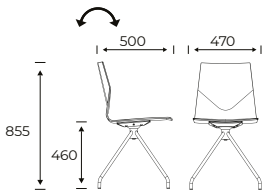
Standard

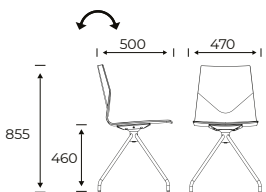

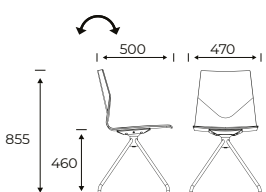

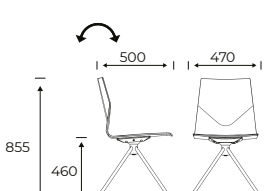



For full colour details [go to page 236](#) ↗

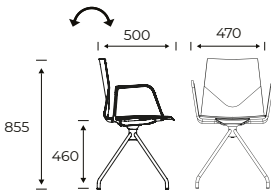

| Product | Description (Item nr) | Weight (Kg) | Dimensions (mm) | Band | Veneer (SEK) | Optional PP (SEK) |
|-------------------------------------------------------------------------------------|--------------------------------------------------------------------------------|-------------|--------------------------------------------------------------------------------------|--------------------------------------------|-------------------------------------------------------------------------------|-------------------------------------------------------------------------------|
|  | 33041 FourCast® 2 One, Wooden shell, With tilt | 4.7 |  | - | 4.720 | 4.720 |
|  | 33043 FourCast® 2 One, Wooden shell, With tilt with return | 5 |  | - | 5.893 | 5.893 |
|  | 33051 FourCast® 2 One, Seat pad, wooden shell, With tilt | 5.8 |  | 1 2 3 4 5 6 7 8 10 | 5.982 6.077 6.172 6.266 6.358 6.454 6.549 6.643 6.861 | 5.982 6.077 6.172 6.266 6.358 6.454 6.549 6.643 6.861 |
|  | 33053 FourCast® 2 One, Seat pad, wooden shell, With tilt with return | 5.9 |  | 1 2 3 4 5 6 7 8 10 | 7.155 7.250 7.345 7.439 7.531 7.627 7.722 7.816 8.034 | 7.155 7.250 7.345 7.439 7.531 7.627 7.722 7.816 8.034 |

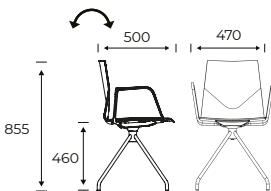
FourCast® 2 One - Veneer

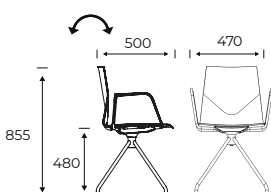
Design by Strand+Hvass

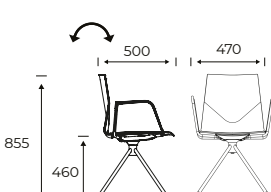
[Content ↗](#)

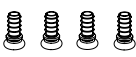
| Product | Description (Item nr) | Weight (Kg) | Dimensions (mm) | Band | Veneer (SEK) | Optional PP (SEK) |
|-----------------------------------------------------------------------------------|---------------------------------------------------------------------------------------------------|-------------|------------------------------------------------------------------------------------|--------------------------------------------|-------------------------------------------------------------------------------|-------------------------------------------------------------------------------|
|  | 33141 FourCast® 2 One with Loop Armrests, Wooden shell, With tilt | 5.9 |  | - | 5.873 | 5.873 |
|  | 33143 FourCast® 2 One with Loop Armrests, Wooden shell, With tilt with return | 6.1 |  | - | 7.046 | 7.046 |
|  | 33151 FourCast® 2 One with Loop Armrests, Seat pad, wooden shell, With tilt | 6.9 |  | 1 2 3 4 5 6 7 8 10 | 7.135 7.230 7.325 7.419 7.511 7.607 7.702 7.796 8.014 | 7.135 7.230 7.325 7.419 7.511 7.607 7.702 7.796 8.014 |
|  | 33153 FourCast® 2 One with Loop Armrests, Seat pad, wooden shell, With tilt with return | 7.1 |  | 1 2 3 4 5 6 7 8 10 | 8.308 8.403 8.498 8.592 8.684 8.780 8.875 8.969 9.187 | 8.308 8.403 8.498 8.592 8.684 8.780 8.875 8.969 9.187 |

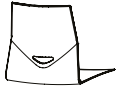
| ACCESSORIES | Description | Weight (Kg) | Dimensions (mm) | Price (SEK) |
|-------------------------------------------------------------------------------------|-----------------------------------------------------------------------------------------------------------------------------|-------------|-----------------|-------------|
| | CHAIR FEET Castors | | | 876 |
| | CHAIR FEET Felt glides, set of 4 pcs. height + 0,2 cm | 1,82 g x 4 | | 208 |
|  | CHAIR FEET Set of 4 pcs. Noise reducing ferrule with big diameter (reduces pressure marks) Chair height + 0,8 cm | 4,8 g x 4 | | 276 |
|  | CHAIR FEET Noise reducing ferrule with felt, set of 4 pcs. Chair height + 1 cm | 6,6 g x 4 | | 276 |
| | CHAIR FEET Teflon glides, set of 4 pcs. Chair height + 0,2 cm | 2,75 g x 4 | | 208 |
|  | GRIP HOLE Available for chairs without inside - and full upholstery | | | 189 |



FourCast® 2 Fire Retardant

Design by Strand+Hvass

[Content ↗](#)



FEATURES

- Shell in Polypropylene
- Polyamide glides are standard
- Linking device optional for model 33200 only
- Stackable on matching trollies



For product information visit oceefour.com ↗

SHELL COLOURS

Standard Polypropylene







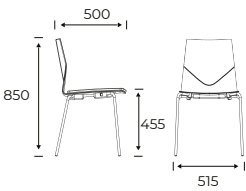

FRAME COLOURS

Standard

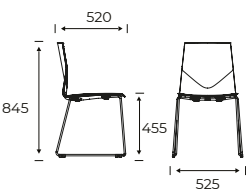

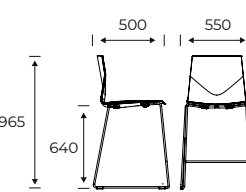

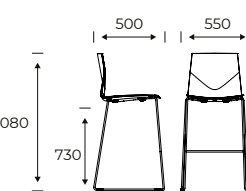





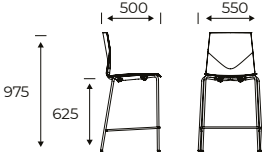

For full colour details [go to page 236](#) ↗

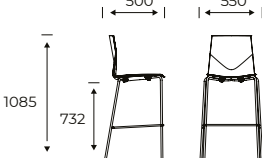
| Product | Description (Item nr) | Weight (Kg) | Stacking on floor | Dimensions (mm) | Band | Standard PP (SEK) |
|------------------------------------------------------------------------------------|-------------------------------------------------------------|-------------|-------------------|--------------------------------------------------------------------------------------|------|-------------------|
|  | 32500 FourCast@ 2 Four, Polypropylene shell | 4.8 | - |  | - | 2.944 |
|  | 33200 FourCast@ 2 Line, Polypropylene shell | 5.7 | - |  | - | 3.430 |
|  | 33800 FourCast@ 2 Counter, Polypropylene shell | 6.6 | - |  | - | 4.384 |
|  | 33900 FourCast@ 2 High, Polypropylene shell | 7.3 | - |  | - | 4.469 |

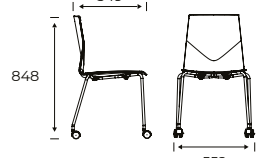
FourCast® 2 Fire Retardant

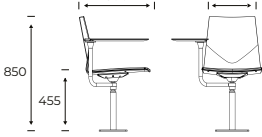
[Content ↗](#)

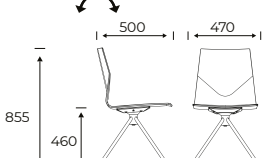

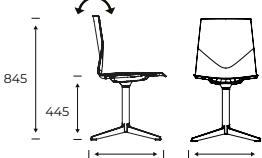





Design by Strand+Hvass

| Product | Description (Item nr) | Weight (Kg) | Stacking on floor | Dimensions (mm) | Band | Standard PP (SEK) |
|-------------------------------------------------------------------------------------|-----------------------------------------------------------------------------|-------------|-------------------|--------------------------------------------------------------------------------------|------|-------------------|
|  | 34000 FourCast@ 2 Counter Four, Polypropylene shell | 7.7 | - |  | - | 4.146 |
|  | 34100 FourCast@ 2 High Four, Polypropylene shell | 6.7 | - |  | - | 4.146 |
|  | 32800 FourCast@ 2 77, Polypropylene shell | 5.8 | - |  | - | 3.388 |
|  | 37001 FourCast@ 2 Audi, Polypropylene shell, With tilt | 11.8 | - |  | - | 8.334 |
|  | 33001 FourCast@ 2 One, Polypropylene shell, With tilt | 6.2 | - |  | - | 4.452 |
|  | 34503 FourCast@ 2 Evo, Polypropylene shell, With tilt with return | 7 | - |  | - | 7.092 |

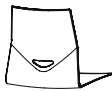
FourCast® 2 Fire Retardant

Design by Strand+Hvass

[Content ↗](#)

| ACCESSORIES | Description | Weight (Kg) | Dimensions (mm) | Price (SEK) |
|-------------------------------------------------------------------------------------|-----------------------------------------------------------------------------------------------------------------------------|-------------|---------------------------------------|-------------|
| | CHAIR FEET Felt glides, set of 4 pcs. height + 0,2 cm | 1,82 g x 4 | | 208 |
|  | CHAIR FEET Set of 4 pcs. Noise reducing ferrule with big diameter (reduces pressure marks) Chair height + 0,8 cm | 4,8 g x 4 | | 276 |
|  | CHAIR FEET Noise reducing ferrule with felt, set of 4 pcs. Chair height + 1 cm | 6,6 g x 4 | | 276 |
| | CHAIR FEET Teflon glides, set of 4 pcs. Chair height + 0,2 cm | 2,75 g x 4 | | 208 |
|  | LINKING DEVICE Chair linking | | C/C 540 mm C/C with armrest 540 mm | 390 |
|  | GRIP HOLE Available for chairs without inside - and full upholstery | | | 189 |
|  | SEAT ROW NUMBER - ACSR0101 16 mm - no. 1 -25 | 29 g | | 1.579 |
|  | SEAT ROW NUMBER - ACSR0102 16 mm - no. 26 -50 | 29 g | | 1.579 |
|  | SEAT ROW NUMBER - ACSR0201 11 mm - no. 1 -25 | 29 g | | 1.579 |
|  | SEAT ROW NUMBER - ACSR0202 11 mm - no. 26 -50 | 29 g | | 1.579 |
|  | CHAIR TROLLEY - 200X0 25 chairs without upholstery | 33,5 Kg | 1100 x 560 x 1970 mm | 8.859 |
|  | INNO@NOTE TROLLEY - 20100007 Trolley for Inno® Note. Room for 51 Inno® Notes. | 58,5 Kg | 1532 x 662 x 1199 mm | 19.942 |

[page 325](#)





FEATURES

- Wooden legs options*
- Polyamide glides as standard
- Powder coated frame options
- *Round oak oiled nature: not available. Black oiled legs: Limited stock available.*



For product information visit oceefour.com ↗

SHELL COLOURS

Standard Polypropylene



FRAME COLOURS





Standard





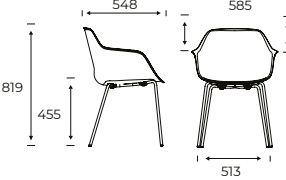

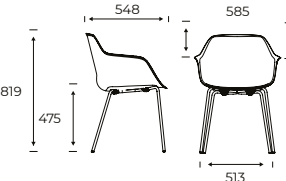
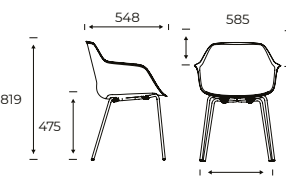

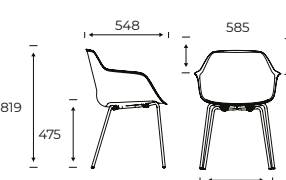

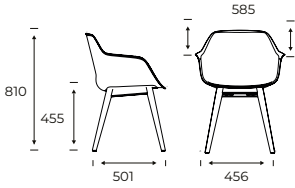

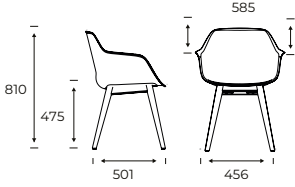

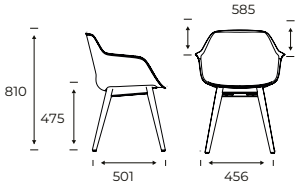

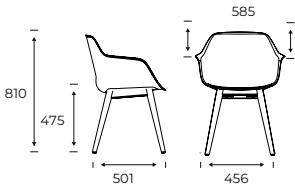

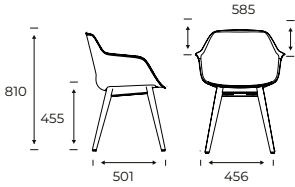
Frame optional*

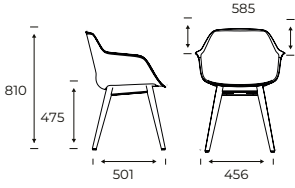

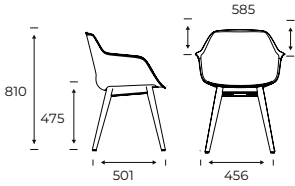

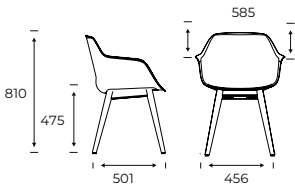

For full colour details [go to page 236](#) ↗

| Product | Description (Item nr) | Weight (Kg) | Dimensions (mm) | Band | Standard PP (SEK) |
|-------------------------------------------------------------------------------------|-------------------------------------------------|-------------|--------------------------------------------------------------------------------------|--------------------------------------------|-------------------------------------------------------------------------------|
|  | 43000 FourMe® 44, Polypropylene shell | 4.9 |  | - | 2.526 |
|  | 43010 FourMe® 44, Seat pad | 5.7 |  | 1 2 3 4 5 6 7 8 10 | 3.788 3.883 3.978 4.072 4.164 4.260 4.355 4.449 4.667 |
|  | 43020 FourMe® 44, Inside upholstery | 5.3 |  | 1 2 3 4 5 6 7 8 10 | 5.214 5.563 5.910 6.259 6.609 6.958 7.306 7.653 8.351 |
|  | 43030 FourMe® 44, Fully upholstered | 5.4 |  | 1 2 3 4 5 6 7 8 10 | 5.989 6.434 6.875 7.320 7.763 8.205 8.648 9.091 9.978 |

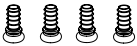
| Product | Description (Item nr) | Weight (Kg) | Dimensions (mm) | Band | Standard PP (SEK) |
|------------------------------------------------------------------------------------|-------------------------------------------------------------------|-------------|--------------------------------------------------------------------------------------|--------------------------------------------|----------------------------------------------------------------------------------|
|  | 43000* FourMe® 44, Polypropylene shell, Oak oil, nature | 4.9 |  | - | 3.778 |
|  | 43010* FourMe® 44, Seat pad, Oak oil, nature | 5.7 |  | 1 2 3 4 5 6 7 8 10 | 5.040 5.135 5.230 5.324 5.416 5.512 5.607 5.701 5.919 |
|  | 43020* FourMe® 44, Inside upholstery, Oak oil, nature | 5.3 |  | 1 2 3 4 5 6 7 8 10 | 6.466 6.815 7.162 7.511 7.861 8.210 8.558 8.905 9.603 |
|  | 43030* FourMe® 44, Fully upholstered, Oak oil, nature | 5.4 |  | 1 2 3 4 5 6 7 8 10 | 7.241 7.686 8.127 8.572 9.015 9.457 9.900 10.343 11.230 |
|  | 43000 FourMe® 44, Polypropylene shell, Oak lacquered | 4.9 |  | - | 4.149 |
|  | 43010 FourMe® 44, Seat pad, Oak lacquered | 5.7 |  | 1 2 3 4 5 6 7 8 10 | 5.411 5.506 5.601 5.695 5.787 5.883 5.978 6.072 6.290 |
|  | 43020 FourMe® 44, Inside upholstery, Oak lacquered | 5.3 |  | 1 2 3 4 5 6 7 8 10 | 6.837 7.186 7.533 7.882 8.232 8.581 8.929 9.276 9.974 |
|  | 43030 FourMe® 44, Fully upholstered, Oak lacquered | 5.4 |  | 1 2 3 4 5 6 7 8 10 | 7.612 8.057 8.498 8.943 9.386 9.828 10.271 10.714 11.601 |

| Product | Description (Item nr) | Weight (Kg) | Dimensions (mm) | Band | Standard PP (SEK) |
|----------------------------------------------------------------------------------|---------------------------------------------------------------------------------|-------------|-----------------|------|-------------------|
|  | 4904 Loose seat pad (Only available for chairs without upholstery) | 4.1 | | 1 | 1.465 |
| | | | | 2 | 1.561 |
| | | | | 3 | 1.657 |
| | | | | 4 | 1.753 |
| | | | | 5 | 1.851 |
| | | | | 6 | 1.947 |
| | | | | 7 | 2.042 |
| | | | | 8 | 2.138 |
| | | | | 10 | 2.360 |

| ACCESSORIES | Description | Weight (Kg) | Dimensions (mm) | Price (SEK) |
|-----------------------------------------------------------------------------------|-----------------------------------------------------------------------------------------------------------------------------|-------------|-----------------|-------------|
| | CHAIR FEET Felt glides, set of 4 pcs. height + 0,2 cm | 1,82 g x 4 | | 208 |
|  | CHAIR FEET Set of 4 pcs. Noise reducing ferrule with big diameter (reduces pressure marks) Chair height + 0,8 cm | 4,8 g x 4 | | 276 |
|  | CHAIR FEET Noise reducing ferrule with felt, set of 4 pcs. Chair height + 1 cm | 6,6 g x 4 | | 276 |
| | CHAIR FEET Teflon glides, set of 4 pcs. Chair height + 0,2 cm | 2,75 g x 4 | | 208 |

| SURCHARGE | | Price (SEK) |
|-----------------------|------------------------------------------------------------------------------------------|-------------|
| FRAME OPTIONAL |  P | 443 |
| |  V | 446 |



FEATURES

- Polyamide glides as standard
- Powder coated frame options

For product information visit oceefour.com ↗

SHELL COLOURS

Standard Polypropylene



FRAME COLOURS

Standard



For full colour details [go to page 236](#) ↗

| Product | Description (Item nr) | Weight (Kg) | Dimensions (mm) | Band | Standard PP (SEK) |
|-------------------------------------------------------------------------------------|-------------------------------------------------|-------------|--------------------------------------------------------------------------------------|--------------------------------------------|--------------------------------------------------------------------------------|
|  | 43200 FourMe® 88, Polypropylene shell | 5,9 |  | - | 2.982 |
|  | 43210 FourMe® 88, Seat pad | 6,7 |  | 1 2 3 4 5 6 7 8 10 | 4.244 4.339 4.434 4.528 4.620 4.716 4.811 4.905 5.123 |
|  | 43220 FourMe® 88, Inside upholstery | 6,3 |  | 1 2 3 4 5 6 7 8 10 | 5.670 6.019 6.366 6.715 7.065 7.414 7.762 8.109 8.807 |
|  | 43230 FourMe® 88, Fully upholstered | 6,4 |  | 1 2 3 4 5 6 7 8 10 | 6.445 6.890 7.331 7.776 8.219 8.661 9.104 9.547 10.434 |

| Product | Description (Item nr) | Weight (Kg) | Dimensions (mm) | Band | Standard PP (SEK) |
|----------------------------------------------------------------------------------|---------------------------------------------------------------------------------|-------------|-----------------|------|----------------------|
|  | 4904 Loose seat pad (Only available for chairs without upholstery) | 4.1 | | 1 | 1.465 |
| | | | | 2 | 1.561 |
| | | | | 3 | 1.657 |
| | | | | 4 | 1.753 |
| | | | | 5 | 1.851 |
| | | | | 6 | 1.947 |
| | | | | 7 | 2.042 |
| | | | | 8 | 2.138 |
| | | | | 10 | 2.360 |

| ACCESSORIES | Description | Weight (Kg) | Dimensions (mm) | Price (SEK) |
|-------------|-------------------------------------------------------------------------|-------------|-----------------|-------------|
| | CHAIR FEET Felt glides, set of 4 pcs. height + 0,2 cm | 1,82 g x 4 | | 208 |
| | CHAIR FEET Teflon glides, set of 4 pcs. Chair height + 0,2 cm | 2,75 g x 4 | | 208 |



FEATURES

- Inno® Tab, flexible and rotating writing tablet
- Gas lift, 41-57,5 cm
- Black base with castors as standard
- Aluminium base options

For product information visit oceefour.com ↗

SHELL COLOURS

Standard Polypropylene



FRAME COLOURS

Standard







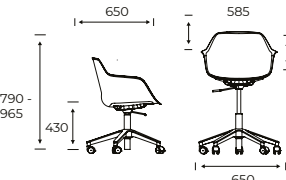

Frame optional*

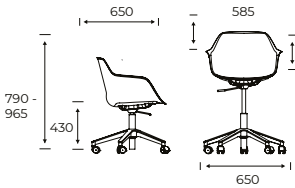

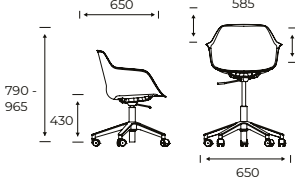
For full colour details [go to page 236](#) ↗

| Product | Description (Item nr) | Weight (Kg) | Dimensions (mm) | Band | Standard PP (SEK) |
|-------------------------------------------------------------------------------------|---------------------------------------------------------------------------|-------------|--------------------------------------------------------------------------------------|--------------------------------------------|-------------------------------------------------------------------------------|
|  | 43404 FourMe® 66, Polypropylene shell, Without tilt with gas | 7.5 |  | - | 3.283 |
|  | 43405 FourMe® 66, Polypropylene shell, With tilt with gas | 7.5 |  | - | 3.647 |
|  | 43414 FourMe® 66, Seat pad, Without tilt with gas | 8.4 |  | 1 2 3 4 5 6 7 8 10 | 4.545 4.640 4.735 4.829 4.921 5.017 5.112 5.206 5.424 |
|  | 43415 FourMe® 66, Seat pad, With tilt with gas | 8.4 |  | 1 2 3 4 5 6 7 8 10 | 4.909 5.004 5.099 5.193 5.285 5.381 5.476 5.570 5.788 |

| Product | Description (Item nr) | Weight (Kg) | Dimensions (mm) | Band | Standard PP (SEK) |
|------------------------------------------------------------------------------------|------------------------------------------------------------------------------|-------------|------------------------------------------------------------------------------------|------------------------------------------------------------------------------------|-------------------------------------------------------------------|
|  | 43424 FourMe® 66, Inside upholstery, Without tilt with gas | 7.9 |  | 1 | 5.971 |
| | | | | 2 | 6.320 |
| | | | | 3 | 6.667 |
| | | | | 4 | 7.016 |
| | | | | 5 | 7.366 |
| | | | | 6 | 7.715 |
| | | | | 7 | 8.063 |
| | | | | 8 | 8.410 |
| | | | | 10 | 9.108 |
| | | | |  | 43425 FourMe® 66, Inside upholstery, With tilt with gas |
| 2 | 6.684 | | | | |
| 3 | 7.031 | | | | |
| 4 | 7.380 | | | | |
| 5 | 7.730 | | | | |
| 6 | 8.079 | | | | |
| 7 | 8.427 | | | | |
| 8 | 8.774 | | | | |
| 10 | 9.472 | | | | |
|  | 43434 FourMe® 66, Fully upholstered, Without tilt with gas | 8.1 |  | | |
| | | | | 2 | 7.191 |
| | | | | 3 | 7.632 |
| | | | | 4 | 8.077 |
| | | | | 5 | 8.520 |
| | | | | 6 | 8.962 |
| | | | | 7 | 9.405 |
| | | | | 8 | 9.848 |
| | | | | 10 | 10.735 |
| | | | |  | 43435 FourMe® 66, Fully upholstered, With tilt with gas |
| 2 | 7.555 | | | | |
| 3 | 7.996 | | | | |
| 4 | 8.441 | | | | |
| 5 | 8.884 | | | | |
| 6 | 9.326 | | | | |
| 7 | 9.769 | | | | |
| 8 | 10.212 | | | | |
| 10 | 11.099 | | | | |
|  | 4904 Loose seat pad (Only available for chairs without upholstery) | 4.1 | | | |
| | | | | 2 | 1.561 |
| | | | | 3 | 1.657 |
| | | | | 4 | 1.753 |
| | | | | 5 | 1.851 |
| | | | | 6 | 1.947 |
| | | | | 7 | 2.042 |
| | | | | 8 | 2.138 |
| | | | | 10 | 2.360 |

| ACCESSORIES | Description | Weight (Kg) | Dimensions (mm) | Price (SEK) |
|-------------------------------------------------------------------------------------|-----------------------------------------------------------------------------------------------------------|-------------|-------------------|-------------|
|  | FOOTRING Gas lift including footring Spand 41 cm. - 57,5 cm. | | 585 - 845 mm | 1.368 |
| | With GS certification | | | 1.489 |
|  | CHAIR FEET Castor with breaks, hard | | | 599 |
| | INNO Foldable Inno® Tab in black with integrated cup holder and dashboard for tablet and phone. | 2,7 KG | 520 x 320 x 23 mm | 2.125 |

| SURCHARGE | | Price (SEK) |
|-----------------------|------------------------------------------------------------------------------------------|-------------|
| FRAME OPTIONAL |  4 | 643 |



Share Basic

Design by Strand+Hvass

[Content ↗](#)



FEATURES



- Take a more informal seat, Share allows you to sit however you feel comfortable – even back to front!
- Customise your chair with a range of standard materials, finishes and colours to choose from
- The following versions SH1, SH2 & SH01 of Share Basic are ecolabeled. This certification applies to all colours and finishes.
- Designed for disassembly – replace parts with ease, including upholstered seat covers.
- Inno®Note tablet options
- Frame available in black, stone grey or white
- Visible fasteners will match the frame colour
- Back cover available in a range of colours
- Curved ledge on the back rest is only available for Polypropylene
- Noise reducing glides
- Stacking protection in black under seat

For product information visit oceefour.com ↗

SEAT / BACK COLOURS

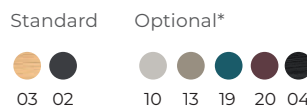



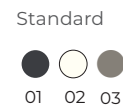



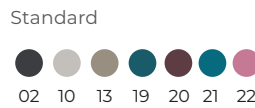

FRAME COLOURS

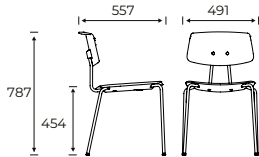

BACK COVER COLOURS

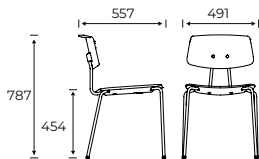

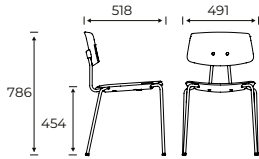
For full colour details [go to page 236](#) ↗

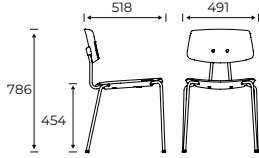



| Product | Description (Item nr) | Weight (Kg) | Stacking on floor | Dimensions (mm) | Band | Price (SEK) |
|--------------------------------------------------------------------------------------------------------------------------------------------------------------------------|-----------------------------------------------------------|-------------|-------------------|--------------------------------------------------------------------------------------|--------------------------------------------|-------------------------------------------------------------------------------|
|   | SH1 Share Basic, Polypropylene | 5 | 12 |  | - | 2.387 |
|  | SH03 Polypropylene Back, Upholstered Seat | 5 | 10 |  | 1 2 3 4 5 6 7 8 10 | 2.810 3.007 3.204 3.401 3.599 3.796 3.993 4.190 4.387 |
|   | SH2 Share Basic, Veneer | 4.6 | 12 |  | - | 3.232 |
|  | SH04 Share Basic, Veneer Back, Upholstered Seat | 4.8 | 10 |  | 1 2 3 4 5 6 7 8 10 | 3.655 3.852 4.049 4.246 4.444 4.641 4.838 5.035 5.232 |

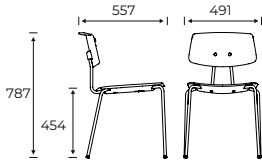

Share Basic

Design by Strand+Hvass

[Content ↗](#)

| Product | Description (Item nr) | Weight (Kg) | Stacking on floor | Dimensions (mm) | Band | Price (SEK) |
|----------------------------------------------------------------------------------|-------------------------------------------------------------|-------------|-------------------|------------------------------------------------------------------------------------|------|-------------|
|  | SH01 Share Basic, Polypropylene Back, Veneer Seat | 4.8 | 12 |  | - | 2.951 |

| ACCESSORIES | Description | Weight (Kg) | Dimensions (mm) | Price (SEK) |
|-------------------------------------------------------------------------------------|-------------------------------------------------------------------------------------------------------------------------------------|-------------|-----------------------------|-------------|
|  | INNO Inno® Note in black, removable and foldable. Not available for chairs with Loop armrest and chairs with wooden legs. | 1,4 KG | 225 x 325 x 10 mm | 1.522 |
|  | INNO@NOTE TROLLEY - 20100007 Trolley for Inno® Note. Room for 51 Inno® Notes. | 58,5 Kg | 1532 x 662 x 1199 mm | 19.942 |
|  | SEAT ROW NUMBER - ACSR0101 16 mm - no. 1 -25 | 29 g | | 1.579 |
|  | SEAT ROW NUMBER - ACSR0102 16 mm - no. 26 -50 | 29 g | | 1.579 |
|  | CHAIR TROLLEY - 200X0 28 chairs with seat pad or 20 chairs with full upholstery | 33,5 Kg | 1100 x 560 x 1910 / 1980 mm | 10.373 |

| SURCHARGE | | Price (SEK) |
|------------------------------------|-------------------------------------------------------------------------------------|-------------|
| PP SEAT / BACK OPTIONAL |  | 141 |
| VENEER SEAT / BACK OPTIONAL |  | 141 |

Share Stool with Steel Legs

Design by Strand+Hvass

[Content ↗](#)



FEATURES

- Take a more informal seat, the Share Stool allows you to sit however you feel comfortable
- Boost comfort with upholstered seat pad or fully upholstered seat option
- Visible fasteners will match the colour of the steel legs
- Option to have seat in black lacquered oak
- PE glides are standard
- Available in 3 heights
- We do not recommend suspensions to fully upholstered and black lacquered versions
- *Share Stools with wooden shell without visible fasteners: Limited stock available



For product information visit oceefour.com ↗

SHELL COLOURS

Veneer



03

FRAME COLOURS

Standard









01 02 03

Optional Seat

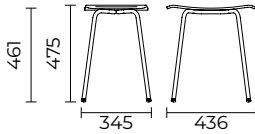

04

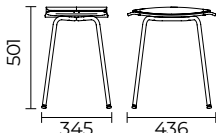
For full colour details [go to page 236](#) ↗

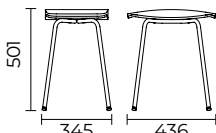
| Product | Description (Item nr) | Weight (Kg) | Dimensions (mm) | Band | Veneer (SEK) | Optional veneer (SEK) |
|------------------------------------------------------------------------------------|--------------------------------------------------------------------------------------------------|-------------|--------------------------------------------------------------------------------------|--------------------------------------------|-------------------------------------------------------------------------------|-------------------------------------------------------------------------------|
|  | SHF15 Share Stool with Steel Legs, Wooden shell with visible fasteners, Tableheight 74 | 2.4 |  | - | 2.094 | 2.539 |
|  | 64040* Share Stool with Steel Legs, Wooden shell, Tableheight 74 | 2.4 |  | - | 2.094 | 2.539 |
|  | SHF16 Share Stool with Steel Legs, Seat pad, wooden shell, Tableheight 74 | 2.7 |  | 1 2 3 4 5 6 7 8 10 | 2.980 3.073 3.167 3.259 3.351 3.443 3.538 3.630 3.730 | 3.425 3.518 3.612 3.704 3.796 3.888 3.983 4.075 4.175 |
|  | SHF14 Share Stool with Steel Legs, Fully upholstered, Tableheight 74 | 2.6 |  | 1 2 3 4 5 6 7 8 10 | 3.341 3.434 3.526 3.619 3.714 3.807 3.899 3.993 4.208 | |

Share Stool with Steel Legs

[Content](#) ↗

Design by Strand+Hvass

| Product | Description (Item nr) | Weight (Kg) | Dimensions (mm) | Band | Veneer (SEK) | Optional veneer (SEK) |
|-------------------------------------------------------------------------------------|---------------------------------------------------------------------------------------------------|-------------|--------------------------------------------------------------------------------------|--------------------------------------------|-------------------------------------------------------------------------------|-------------------------------------------------------------------------------|
|  | SHF25 Share Stool with Steel Legs, Wooden shell with visible fasteners, Tableheight 90 | 4 |  | - | 2.498 | 2.943 |
|  | 64041* Share Stool with Steel Legs, Wooden shell, Tableheight 90 | 4 |  | - | 2.498 | 2.943 |
|  | SHF26 Share Stool with Steel Legs, Seat pad, wooden shell, Tableheight 90 | 4.3 |  | 1 2 3 4 5 6 7 8 10 | 3.527 3.621 3.710 3.810 3.900 3.994 4.086 4.179 4.398 | 3.972 4.066 4.155 4.255 4.345 4.439 4.531 4.624 4.843 |
|  | SHF24 Share Stool with Steel Legs, Fully upholstered, Tableheight 90 | 4.1 |  | 1 2 3 4 5 6 7 8 10 | 3.890 3.984 4.077 4.169 4.263 4.355 4.448 4.542 4.759 | |
|  | SHF35 Share Stool with Steel Legs, Wooden shell with visible fasteners, Tableheight 105 | 4.3 |  | - | 2.892 | 3.337 |
|  | 64042* Share Stool with Steel Legs, Wooden shell, Tableheight 105 | 4.3 |  | - | 2.892 | 3.337 |
|  | SHF36 Share Stool with Steel Legs, Seat pad, wooden shell, Tableheight 105 | 4.6 |  | 1 2 3 4 5 6 7 8 10 | 4.071 4.165 4.258 4.350 4.443 4.537 4.630 4.723 4.940 | 4.516 4.610 4.703 4.795 4.888 4.982 5.075 5.168 5.385 |
|  | SHF34 Share Stool with Steel Legs, Fully upholstered, Tableheight 105 | 4.5 |  | 1 2 3 4 5 6 7 8 10 | 4.434 4.525 4.620 4.712 4.807 4.897 4.991 5.085 5.300 | |

| ACCESSORIES | Description | Weight (Kg) | Dimensions (mm) | Price (SEK) |
|-------------|-----------------------------------------------------------------|-------------|-----------------|-------------|
| | CHAIR FEET Felt glides, set of 4 pcs. height + 0,2 cm | 1,82 g x 4 | | 208 |

Share Stool with Wooden Legs

Design by Strand+Hvass

[Content ↗](#)



FEATURES

- Take a more informal seat, the Share Stool allows you to sit however you feel comfortable
- Boost comfort with upholstered seat pad or fully upholstered seat option
- Visible fasteners are available in black, grey and white
- Option to have seat in black lacquered oak
- Frame in black lacquered oak options
- PE glides are standard
- Available in 3 heights
- We do not recommend suspensions to fully upholstered and black lacquered versions
- *Share Stools with wooden shell without visible fasteners: Limited stock available



For product information visit oceefour.com ↗

SHELL COLOURS

Veneer



03



04

FRAME COLOURS

Standard



U







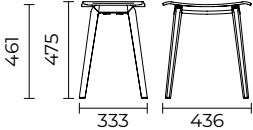

V

Optional Seat

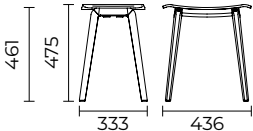

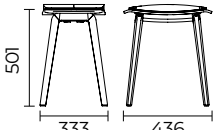

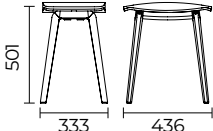







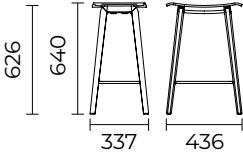

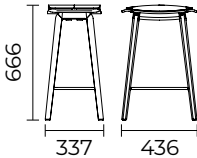
Frame optional*

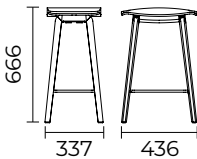
For full colour details [go to page 236](#) ↗

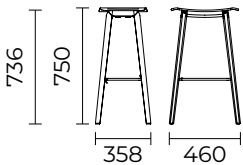
| Product | Description (Item nr) | Weight (Kg) | Dimensions (mm) | Band | Veneer (SEK) | Optional veneer (SEK) |
|------------------------------------------------------------------------------------|---------------------------------------------------------------------------------------------------|-------------|--------------------------------------------------------------------------------------|--------------------------------------------|-------------------------------------------------------------------------------|-------------------------------------------------------------------------------|
|  | SHG15 Share Stool with Wooden Legs, Wooden shell with visible fasteners, Tableheight 74 | 2.1 |  | - | 3.478 | 3.923 |
|  | 63640* Share Stool with Wooden Legs, Wooden shell, Tableheight 74 | 2.1 |  | - | 3.478 | 3.923 |
|  | SHG16 Share Stool with Wooden Legs, Seat pad, wooden shell, Tableheight 74 | 2.4 |  | 1 2 3 4 5 6 7 8 10 | 4.614 4.704 4.793 4.882 4.973 5.062 5.151 5.241 5.450 | 5.059 5.149 5.238 5.327 5.418 5.507 5.596 5.686 5.895 |
|  | SHG14 Share Stool with Wooden Legs, Fully upholstered, Tableheight 74 | 2.3 |  | 1 2 3 4 5 6 7 8 10 | 4.963 5.052 5.141 5.232 5.320 5.410 5.501 5.589 5.799 | |

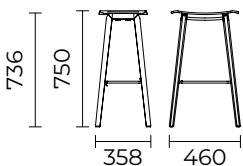
Share Stool with Wooden Legs

Design by Strand+Hvass

| Product | Description (Item nr) | Weight (Kg) | Dimensions (mm) | Band | Veneer (SEK) | Optional veneer (SEK) |
|-------------------------------------------------------------------------------------|---------------------------------------------------------------------------------------------------|-------------|--------------------------------------------------------------------------------------|--------------------------------------------|-------------------------------------------------------------------------------|-------------------------------------------------------------------------------|
|  | SHG25 Share Stool with Wooden Legs, Wooden shell with visible fastners, Tableheight 90 | 3.5 |  | - | 4.872 | 5.317 |
|  | 63641* Share Stool with Wooden Legs, Wooden shell, Tableheight 90 | 3.5 |  | - | 4.872 | 5.317 |
|  | SHG26 Share Stool with Wooden Legs, Seat pad, wooden shell, Tableheight 90 | 3.8 |  | 1 2 3 4 5 6 7 8 10 | 6.008 6.098 6.186 6.276 6.366 6.456 6.544 6.635 6.844 | 6.453 6.543 6.631 6.721 6.811 6.901 6.989 7.080 7.289 |
|  | SHG24 Share Stool with Wooden Legs, Fully upholstered, Tableheight 90 | 3.7 |  | 1 2 3 4 5 6 7 8 10 | 6.357 6.445 6.536 6.626 6.715 6.805 6.894 6.984 7.193 | |
|  | SHG35 Share Stool with Wooden Legs, Wooden shell with visible fastners, Tableheight 105 | 3.8 |  | - | 4.899 | 5.344 |
|  | 63642* Share Stool with Wooden Legs, Wooden shell, Tableheight 105 | 3.8 |  | - | 4.899 | 5.344 |
|  | SHG36 Share Stool with Wooden Legs, Seat pad, wooden shell, Tableheight 105 | 4.1 |  | 1 2 3 4 5 6 7 8 10 | 6.035 6.124 6.214 6.303 6.394 6.482 6.572 6.662 6.871 | 6.480 6.569 6.659 6.748 6.839 6.927 7.017 7.107 7.316 |
|  | SHG34 Share Stool with Wooden Legs, Fully upholstered, Tableheight 105 | 3.9 |  | 1 2 3 4 5 6 7 8 10 | 6.383 6.473 6.563 6.651 6.740 6.832 6.922 7.010 7.221 | |

Share Stool with Wooden Legs

[Content ↗](#)

Design by Strand+Hvass

| ACCESSORIES | Description | Weight (Kg) | Dimensions (mm) | Price (SEK) |
|-----------------------------------------------------------------------------------|-------------------------------------------------------------|-------------|-----------------|-------------|
|  | FOOT REST COLOUR Black matt standard Ral 7021 | | | |
|  | FOOT REST COLOUR White matt standard Ral 9010 | | | |
|  | FOOT REST COLOUR Stonegrey matt standard Ral 7039 | | | |

| SURCHARGE | | Price (SEK) |
|-----------------------|----------------------------------------------------------------------------------------|-------------|
| FRAME OPTIONAL |  V | 445 |



Share Bench with Steel Legs

Design by Strand+Hvass

[Content ↗](#)



FEATURES

- Take a more informal seat, the Share Bench allows you to sit however you feel comfortable
- Boost comfort with upholstered seat pad or fully upholstered seat option
- Visible fasteners will match the colour of the steel legs
- Option to have seat in black lacquered oak
- PE glides are standard
- Available in 3 lengths
- We do not recommend suspensions to fully upholstered and black lacquered versions
- *Share Bench with wooden shell without visible fasteners: Limited stock available



For product information visit oceefour.com ↗

SHELL COLOURS

Veneer



03

FRAME COLOURS

Standard



01 02 03

Optional Seat



04











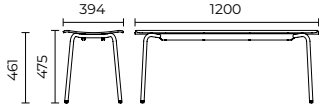

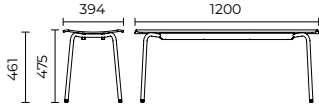

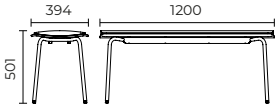
For full colour details [go to page 236](#) ↗

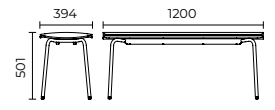
| Product | Description (Item nr) | Weight (Kg) | Dimensions (mm) | Band | Veneer (SEK) | Optional veneer (SEK) |
|---------|-------------------------------------------------------------------------------------------|-------------|-----------------|--------------------------------------------|-------------------------------------------------------------------------------|-------------------------------------------------------------------------------|
| | SHH15 Share Bench with Steel Legs, Wooden shell with visible fasteners, 1000 mm | 6.2 | | - | 3.718 | 4.163 |
| | 64341* Share Bench with Steel Legs, Wooden shell, 1000 mm | 6.2 | | - | 3.718 | 4.163 |
| | SHH16 Share Bench with Steel Legs, Seat pad, wooden shell, 1000 mm | 7.1 | | 1 2 3 4 5 6 7 8 10 | 5.874 6.148 6.423 6.696 6.971 7.244 7.519 7.794 8.370 | 6.319 6.593 6.868 7.141 7.416 7.689 7.964 8.239 8.815 |
| | SHH14 Share Bench with Steel Legs, Fully upholstered, 1000 mm | 6.8 | | 1 2 3 4 5 6 7 8 10 | 6.539 6.813 7.088 7.361 7.634 7.907 8.183 8.456 9.032 | |

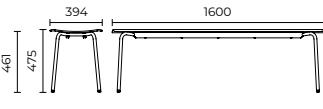
Share Bench with Steel Legs

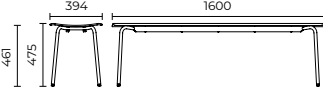
[Content ↗](#)

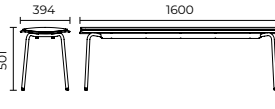
Design by Strand+Hvass

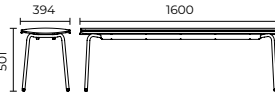
| Product | Description (Item nr) | Weight (Kg) | Dimensions (mm) | Band | Veneer (SEK) | Optional veneer (SEK) |
|-------------------------------------------------------------------------------------|-------------------------------------------------------------------------------------------|-------------|--------------------------------------------------------------------------------------|--------------------------------------------|------------------------------------------------------------------------------------|-------------------------------------------------------------------------------------|
|  | SHH215 Share Bench with Steel Legs, Wooden shell with visible fastners, 1200 mm | 7 |  | - | 3.984 | 4.429 |
|  | 64342* Share Bench with Steel Legs, Wooden shell, 1200 mm | 7 |  | - | 3.984 | 4.429 |
|  | SHH216 Share Bench with Steel Legs, Seat pad, wooden shell, 1200 mm | 8.1 |  | 1 2 3 4 5 6 7 8 10 | 6.265 6.663 7.062 7.460 7.859 8.257 8.655 9.053 9.755 | 6.710 7.108 7.507 7.905 8.304 8.702 9.100 9.498 10.200 |
|  | SHH214 Share Bench with Steel Legs, Fully upholstered, 1200 mm | 7.6 |  | 1 2 3 4 5 6 7 8 10 | 6.929 7.327 7.726 8.124 8.523 8.921 9.319 9.717 10.420 | |
|  | SHH315 Share Bench with Steel Legs, Wooden shell with visible fastners, 1600 mm | 5.1 |  | - | 4.647 | 5.092 |
|  | 64343* Share Bench with Steel Legs, Wooden shell, 1600 mm | 5.1 |  | - | 4.647 | 5.092 |
|  | SHH316 Share Bench with Steel Legs, Seat pad, wooden shell, 1600 mm | 6.5 |  | 1 2 3 4 5 6 7 8 10 | 7.884 8.571 9.261 9.949 10.639 11.327 12.015 12.705 13.697 | 8.329 9.016 9.706 10.394 11.084 11.772 12.460 13.150 14.142 |
|  | SHH314 Share Bench with Steel Legs, Fully upholstered, 1600 mm | 5.9 |  | 1 2 3 4 5 6 7 8 10 | 7.221 7.907 8.597 9.286 9.975 10.663 11.352 12.041 13.034 | |

| ACCESSORIES | Description | Weight (Kg) | Dimensions (mm) | Price (SEK) |
|-------------|-----------------------------------------------------------------|-------------|-----------------|-------------|
| | CHAIR FEET Felt glides, set of 4 pcs. height + 0,2 cm | 1,82 g x 4 | | 208 |







FEATURES

- CMHR foam

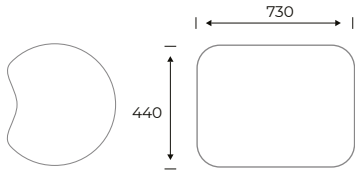
For product information visit oceefour.com ↗

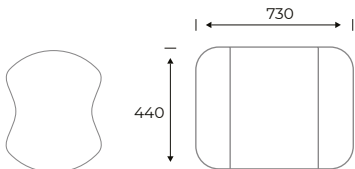
For full colour details [go to page 236](#) ↗

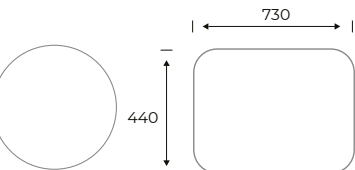
| Product | Description (Item nr) | Weight (Kg) | Dimensions (mm) | Band | Standard (SEK) |
|------------------------------------------------------------------------------------|-----------------------------------------------|-------------|--------------------------------------------------------------------------------------|-----------------------------------------------------------------------------------------------------------------------|---------------------------------------------------------------------------------------------------------------------------------------------------|
|  | CASINOCA1 Casino CAS1C, CAS1C | - |  | <ul style="list-style-type: none"> 1 2 3 4 5 6 7 | <ul style="list-style-type: none"> 3.787 4.234 4.646 5.442 6.510 8.127 9.794 |
|  | CASINOCA2 Casino CAS2C, CAS2C | - |  | <ul style="list-style-type: none"> 1 2 3 4 5 6 7 | <ul style="list-style-type: none"> 3.787 4.234 4.646 5.442 6.510 8.127 9.794 |
|  | CASINOCAC Casino CAS1CIRC, CAS1CIRC | - |  | <ul style="list-style-type: none"> 1 2 3 4 5 6 7 | <ul style="list-style-type: none"> 3.787 4.234 4.646 5.442 6.510 8.127 9.794 |



FourReal® 74 with Angled Legs

Design by Studio Ocee

[Content ↗](#)



FEATURES



- Table height 74 cm. Angled legs - integrated castors on two legs.
- With height adjustment glides on the other two legs to aid movement
- Foldable by one person without the use of tools. Matching ABS edges.
- Room In Room & Chair suspension options. Room In Room comes in Decor as standard.
- Electrical units are optional and will be positioned in the centre of tables as standard.

For product information visit oceefour.com ↗

TABLE TOP

Decor



Laminate



Fenix laminate



Linoleum



FRAME COLOURS

Standard



Frame optional*



For electrical accessories [go to page 228](#) ↗

For full colour details [go to page 236](#) ↗









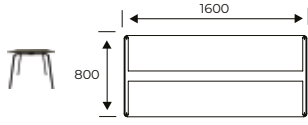

| Product | Description (Item nr) | Weight (Kg) | Chair suspension | Dimensions (mm) | Top/Band | Price (SEK) |
|---------|------------------------------------------------------------------------|-------------|------------------|-----------------|-------------------------------------------------|------------------------------------|
| | 21980 FourReal® 74 with Angled Legs, 80 x 80, Folding legs | 19.5 | 2 | | Decor Laminate Fenix laminate Linoleum | 6.245 6.712 8.003 9.407 |
| | 21800 FourReal® 74L with Angled Legs, 128 x 64, Folding legs | 21.4 | 2 | | Decor Laminate Fenix laminate Linoleum | 6.525 7.377 9.195 11.021 |
| | 21810 FourReal® 74L with Angled Legs, 140 x 70, Folding legs | 24.1 | 2 | | Decor Laminate Fenix laminate Linoleum | 6.731 7.745 10.005 11.390 |
| | 21900 FourReal® 74 with Angled Legs, 120 x 80, Folding legs | 24 | 4 | | Decor Laminate Fenix laminate Linoleum | 6.615 7.628 9.781 11.146 |
| | 21910 FourReal® 74 with Angled Legs, 140 x 80, Folding legs | 26.3 | 4 | | Decor Laminate Fenix laminate Linoleum | 6.909 7.987 10.648 11.797 |

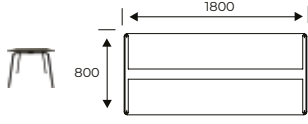
For tabletop cutout placements go to: Oceedesign.com/Cutout.pdf

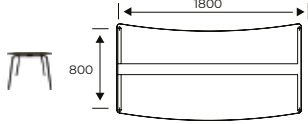
FourReal® 74 with Angled Legs

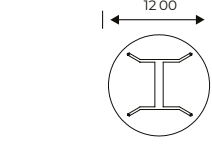
[Content ↗](#)

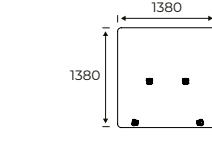
Design by Studio Ocee

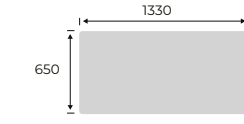



| Product | Description (Item nr) | Weight (Kg) | Chair suspension | Dimensions (mm) | Top/Band | Price (SEK) |
|------------------------------------------------------------------------------------|-----------------------------------------------------------------------------|-------------|------------------|--------------------------------------------------------------------------------------|----------------|-------------|
|  | 21950 FourReal® 74 with Angled Legs, 160 x 80, Folding legs | 31.6 | 4 |  | Decor | 7.280 |
| | | | | | Laminate | 8.599 |
| | | | | | Fenix laminate | 11.765 |
| | | | | | Linoleum | 12.375 |
|  | 21920 FourReal® 74 with Angled Legs, 180 x 80, Folding legs | 31.5 | 6 |  | Decor | 7.481 |
| | | | | | Laminate | 8.930 |
| | | | | | Fenix laminate | 12.368 |
| | | | | | Linoleum | 12.684 |
|  | 219A0 FourReal® 74 with Angled Legs, 180 x 80 curve, Folding legs | 39.7 | 6 |  | Decor | 8.151 |
| | | | | | Laminate | 9.601 |
| | | | | | Fenix laminate | 13.593 |
| | | | | | Linoleum | 14.679 |
|  | 21930 FourReal® 74 with Angled Legs, Ø120, Folding legs | 27 | 2 |  | Decor | 7.247 |
| | | | | | Laminate | 8.532 |
| | | | | | Fenix laminate | 11.858 |
| | | | | | Linoleum | 13.373 |
|  | 2421 Room in Room, FourReal® 74 with Angled Legs | 26.3 | - |  | Decor | 3.502 |
| | | | | | Laminate | |
| | | | | | Fenix laminate | |
| | | | | | Linoleum | |
|  | 2430000 Acoustic for RinR, 133 x 65 | 6.7 | - |  | 1 | 2.852 |
| | | | | | 2 | 3.065 |
| | | | | | 3 | 3.279 |
| | | | | | 4 | 3.503 |
| | | | | | 5 | 3.706 |
| | | | | | 6 | 3.909 |

[For tabletop cutout placements go to: Oceedesign.com/Cutout.pdf](https://oceedesign.com/Cutout.pdf)

FourReal® 74 with Angled Legs

Design by Studio Ocee

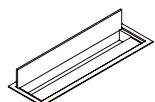
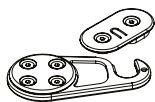
[Content ↗](#)

| ACCESSORIES | Description | Weight (Kg) | Dimensions (mm) | Price (SEK) |
|------------------------------------------------------------------------------------|-----------------------------------------------------------------------------------------------------------------------------------------------------------------------|-------------|----------------------------------------------------|-------------|
|  | CHAIR SUSPENSION Chair suspension for FourCast2 Four, FourCast2 Line, FourSure 44, FourSure 88, FourSure 11, FourSure 99, Four Stools, Four Seating Benches | 0,3 Kg | | 255 |
|  | CHAIR SUSPENSION Chair suspension for FourCast2 Wheeler, FourSure 66 | 0,3 Kg | | 255 |
|  | CABLE CUT OUT Cable duct, aluminum. Cable duct placed in apron | | | 2.030 |
| | CABLE CUT OUT | | | 711 |
|  | LINKING DEVICE Linking Device, set of 4 pcs - 2 x he, 2 x she per table | | | 525 |
|  | TABLE TROLLEY - 20100001 Trolley for 10 Folded Tables or 7 round tables, including strap | 20 Kg | 1720 mm x 550 mm x 980 mm. Folded Table: 150 mm | 8.773 |
| SURCHARGE | | | | Price (SEK) |
| FRAME OPTIONAL |  6 | | | 382 |

FourReal® 74 with Straight Legs

Design by Studio Ocee

[Content](#) ↗



FEATURES

- Table height 74 cm. Straight legs – Integrated castors on two legs.
- With height adjustment glides on the other two legs to aid movement
- Foldable by one person without the use of tools. Matching ABS edges.
- Room In Room & Chair suspension options. Room In Room comes in Decor as standard.
- Electrical units are optional and will be positioned in the centre of tables as standard.



For product information visit oceefour.com ↗

TABLE TOP

Decor



04 05 06

Laminate



01 02 03

Fenix laminate



07 08 09

Linoleum



10

FRAME COLOURS

Standard



B C K

Frame optional*



6

For electrical accessories [go to page 228](#) ↗

For full colour details [go to page 236](#) ↗









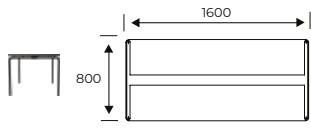

| Product | Description (Item nr) | Weight (Kg) | Chair suspension | Dimensions (mm) | Top/Band | Price (SEK) |
|---------|--------------------------------------------------------------------------|-------------|------------------|-----------------|-------------------------------------------------|------------------------------------|
| | 22080 FourReal® 74 with Straight Legs, 80 x 80, Folding legs | 20.2 | 2 | | Decor Laminate Fenix laminate Linoleum | 6.245 6.712 8.003 9.407 |
| | 21600 FourReal® 74L with Straight Legs, 128 x 64, Folding legs | 22 | 2 | | Decor Laminate Fenix laminate Linoleum | 6.525 7.377 9.195 11.021 |
| | 21610 FourReal® 74L with Straight Legs, 140 x 70, Folding legs | 24.7 | 2 | | Decor Laminate Fenix laminate Linoleum | 6.731 7.745 10.005 11.390 |
| | 22000 FourReal® 74 with Straight Legs, 120 x 80, Folding legs | 24.6 | 4 | | Decor Laminate Fenix laminate Linoleum | 6.615 7.628 9.781 11.146 |
| | 22010 FourReal® 74 with Straight Legs, 140 x 80, Folding legs | 26.9 | 4 | | Decor Laminate Fenix laminate Linoleum | 6.909 7.987 10.648 11.797 |

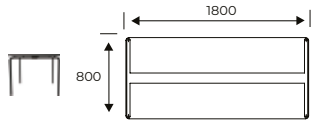
For tabletop cutout placements go to: Oceedesign.com/Cutout.pdf

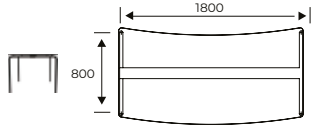
FourReal® 74 with Straight Legs

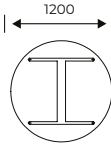
Design by Studio Ocee

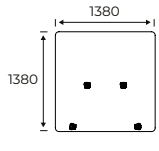
[Content ↗](#)

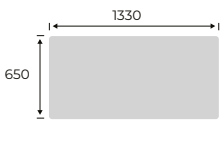



| Product | Description (Item nr) | Weight (Kg) | Chair suspension | Dimensions (mm) | Top/Band | Price (SEK) |
|------------------------------------------------------------------------------------|-------------------------------------------------------------------------------|-------------|------------------|--------------------------------------------------------------------------------------|----------------|-------------|
|  | 22050 FourReal® 74 with Straight Legs, 160 x 80, Folding legs | 32.2 | 4 |  | Decor | 7.280 |
| | | | | | Laminate | 8.599 |
| | | | | | Fenix laminate | 11.765 |
| | | | | | Linoleum | 12.375 |
|  | 22020 FourReal® 74 with Straight Legs, 180 x 80, Folding legs | 32.2 | 6 |  | Decor | 7.481 |
| | | | | | Laminate | 8.930 |
| | | | | | Fenix laminate | 12.368 |
| | | | | | Linoleum | 12.684 |
|  | 220A0 FourReal® 74 with Straight Legs, 180 x 80 curve, Folding legs | - | 6 |  | Decor | 8.151 |
| | | | | | Laminate | 9.601 |
| | | | | | Fenix laminate | 13.593 |
| | | | | | Linoleum | 14.679 |
|  | 22030 FourReal® 74 with Straight Legs, Ø120, Folding legs | 28.1 | 2 |  | Decor | 7.247 |
| | | | | | Laminate | 8.532 |
| | | | | | Fenix laminate | 11.858 |
| | | | | | Linoleum | 13.373 |
|  | 2420 Room in Room, FourReal® 74 with Straight Legs | 26.3 | - |  | Decor | 3.502 |
| | | | | | Laminate | |
| | | | | | Fenix laminate | |
| | | | | | Linoleum | |
|  | 2430000 Acoustic for RinR, 133 x 65 | 6.7 | - |  | 1 | 2.852 |
| | | | | | 2 | 3.065 |
| | | | | | 3 | 3.279 |
| | | | | | 4 | 3.503 |
| | | | | | 5 | 3.706 |
| | | | | | 6 | 3.909 |

For tabletop cutout placements go to: [Oceedesign.com/Cutout.pdf](https://oceedesign.com/Cutout.pdf)

FourReal® 74 with Straight Legs

Design by Studio Ocee

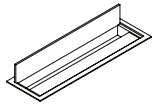
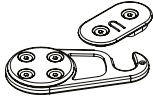
[Content ↗](#)

| ACCESSORIES | Description | Weight (Kg) | Dimensions (mm) | Price (SEK) |
|------------------------------------------------------------------------------------|-----------------------------------------------------------------------------------------------------------------------------------------------------------------------|-------------|----------------------------------------------------|-------------|
|  | CHAIR SUSPENSION Chair suspension for FourCast2 Four, FourCast2 Line, FourSure 44, FourSure 88, FourSure 11, FourSure 99, Four Stools, Four Seating Benches | 0,3 Kg | | 255 |
|  | CHAIR SUSPENSION Chair suspension for FourCast2 Wheeler, FourSure 66 | 0,3 Kg | | 255 |
|  | CABLE CUT OUT Cable duct, aluminum. Cable duct placed in apron | | | 2.030 |
| | CABLE CUT OUT | | | 711 |
|  | LINKING DEVICE Linking Device, set of 4 pcs - 2 x he, 2 x she per table | | | 525 |
|  | TABLE TROLLEY - 20100001 Trolley for 10 Folded Tables or 7 round tables, including strap | 20 Kg | 1720 mm x 550 mm x 980 mm. Folded Table: 150 mm | 8.773 |
| SURCHARGE | | | | Price (SEK) |
| FRAME OPTIONAL |  6 | | | 382 |

FourReal® 741 Flake

Design by Studio Ocee

[Content ↗](#)



FEATURES



- Table height 74 cm. Angled legs – integrated castors on two legs
- With height adjustment glides on the other two legs to aid movement
- Foldable by one person without the use of tools. Matching ABS edges.
- Room In Room & Chair suspension options. Room In Room comes in Decor as standard.
- Powder coated frame options
- Electrical units are optional and will be positioned in the centre of tables as standard.

For product information visit oceefour.com ↗

TABLE TOP

Decor



Laminate



Fenix laminate



Linoleum



FRAME COLOURS

Standard



Frame optional*





For electrical accessories [go to page 228](#) ↗

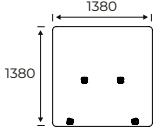

For full colour details [go to page 236](#) ↗

| Product | Description (Item nr) | Weight (Kg) | Chair suspension | Dimensions (mm) | Top/Band | Price (SEK) |
|---------|---------------------------------------------------------------------------|-------------|------------------|-----------------|-------------------------------------------------|--------------------------------------|
| | 21700 FourReal® 741 Flake, 140 x 100, Folding legs | 33.9 | 4 | | Decor Laminate Fenix laminate Linoleum | 8.126 9.446 13.079 14.279 |
| | 21720 FourReal® 741 Flake, 200 x 100, Folding legs | 50.3 | 0 | | Decor Laminate Fenix laminate Linoleum | 11.082 12.999 18.146 19.612 |
| | 21750 FourReal® 741 Flake, 198 x 100 ellipse, Folding legs | 37.1 | 4 | | Decor Laminate Fenix laminate Linoleum | 10.814 12.682 17.703 19.119 |
| | 21760 FourReal® 741 Flake, 160 x 100 half ellipse, Folding legs | 31.6 | 4 | | Decor Laminate Fenix laminate Linoleum | 8.514 9.783 12.323 13.308 |
| | 21770 FourReal® 741 Flake, 140 x 129 Diamond, Folding legs | 30.4 | 3 | | Decor Laminate Fenix laminate Linoleum | 9.029 10.872 13.955 15.068 |

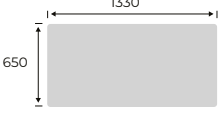
For tabletop cutout placements go to: Oceedesign.com/Cutout.pdf

| Product | Description (Item nr) | Weight (Kg) | Chair suspension | Dimensions (mm) | Top/Band | Price (SEK) |
|----------------------------------------------------------------------------------|-----------------------------------------------|-------------|------------------|------------------------------------------------------------------------------------|-------------------------------------------------|----------------------------------------------------|
|  | 2422 Room in Room, FourReal 741 | 26.4 | - |  | Decor Laminate Fenix laminate Linoleum | 3.502 |
|  | 2430000 Acoustic for RinR, 133 x 65 | 6.7 | - |  | 1 2 3 4 5 6 | 2.852 3.065 3.279 3.503 3.706 3.909 |

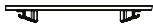
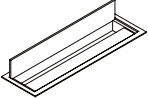
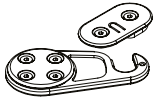
For tabletop cutout placements go to: [Oceedesign.com/Cutout.pdf](https://oceedesign.com/Cutout.pdf)

| ACCESSORIES | Description | Weight (Kg) | Dimensions (mm) | Price (SEK) |
|-------------------------------------------------------------------------------------|-----------------------------------------------------------------------------------------------------------------------------------------------------------------------|-------------|----------------------------------------------------|-------------|
|  | CHAIR SUSPENSION Chair suspension for FourCast2 Four, FourCast2 Line, FourSure 44, FourSure 88, FourSure 11, FourSure 99, Four Stools, Four Seating Benches | 0,3 Kg | | 255 |
|  | CHAIR SUSPENSION Chair suspension for FourCast2 Wheeler, FourSure 66 | 0,3 Kg | | 255 |
|  | CABLE CUT OUT Cable duct, aluminum. Cable duct placed in apron | | | 2.030 |
| | CABLE CUT OUT | | | 711 |
|  | LINKING DEVICE Linking Device, set of 4 pcs - 2 x he, 2 x she per table | | | 525 |
|  | TABLE TROLLEY - 20100001 Trolley for 10 Folded Tables or 7 round tables, including strap | 20 Kg | 1720 mm x 550 mm x 980 mm. Folded Table: 150 mm | 8.773 |

| SURCHARGE | | Price (SEK) |
|-----------------------|------------------------------------------------------------------------------------------|-------------|
| FRAME OPTIONAL |  6 | 382 |



FEATURES



- Table height 74 cm. Angled legs - integrated castors on two legs
- Optional 25 mm gap between tabletops for accessory mounting
- Personalise with trays, paper rolls, power cubes, acoustic panels and cable nets
- Electrical installation option for tabletops without 25 mm gap
- Possibility of chair suspension and to install cable net
- Powder-coated frame colour
- ABS edge matches tabletop colour
- Delivered flat-packed; easy to assemble and install

For product information visit oceefour.com ↗

TABLE TOP

Decor



Laminate



FRAME COLOURS

Standard



Fenix laminate





Linoleum





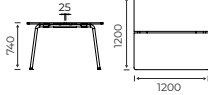
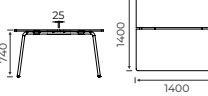

For electrical accessories [go to page 228](#) ↗



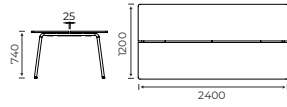

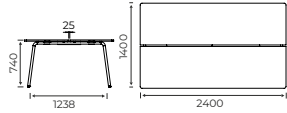

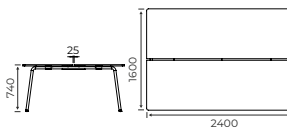
For full colour details [go to page 236](#) ↗

| Product | Description (Item nr) | Weight (Kg) | Max Chair suspension | Dimensions (mm) | Top/Band | Price (SEK) |
|-------------------------------------------------------------------------------------|-----------------------------------------|-------------|----------------------|--------------------------------------------------------------------------------------|----------------|-------------|
|  | REE16 FourReal® Flex, 120x120 | 37,8 | 4 |  | Decor | 11.717 |
| | | | | | Laminate | 13.730 |
| | | | | | Fenix laminate | 16.492 |
| | | | | | Linoleum | 18.406 |
|  | REE2H FourReal® Flex, 140x140 | 47,3 | 4 |  | Decor | 13.280 |
| | | | | | Laminate | 17.000 |
| | | | | | Fenix laminate | 18.163 |
| | | | | | Linoleum | 22.414 |
|  | REE35 FourReal® Flex, 160x160 | 57,7 | 4 |  | Decor | 14.842 |
| | | | | | Laminate | 19.710 |
| | | | | | Fenix laminate | 26.514 |
| | | | | | Linoleum | 25.875 |
|  | REE3U FourReal® Flex, 180x120 | 43,6 | 6 |  | Decor | 17.030 |
| | | | | | Laminate | 20.001 |
| | | | | | Fenix laminate | 22.572 |
| | | | | | Linoleum | 26.353 |
|  | REE4C FourReal® Flex, 200x140 | 54,2 | 6 |  | Decor | 19.530 |
| | | | | | Laminate | 25.716 |
| | | | | | Fenix laminate | 27.388 |
| | | | | | Linoleum | 32.524 |

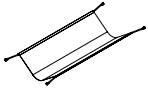
For tabletop cutout placements go to: [Oceefour.com/Cutout.pdf](https://oceefour.com/Cutout.pdf)

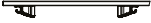
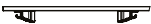
| Product | Description (Item nr) | Weight (Kg) | Max Chair suspension | Dimensions (mm) | Top/Band | Price (SEK) |
|-----------------------------------------------------------------------------------|-----------------------------------------|-------------|----------------------|------------------------------------------------------------------------------------|----------------|-------------|
|  | REE69 FourReal® Flex, 240x120 | 65,7 | 8 |  | Decor | 20.155 |
| | | | | | Laminate | 20.155 |
| | | | | | Fenix laminate | 30.415 |
| | | | | | Linoleum | 33.835 |
|  | REE6A FourReal® Flex, 240x140 | 73,4 | 8 |  | Decor | 22.811 |
| | | | | | Laminate | 29.579 |
| | | | | | Fenix laminate | 32.478 |
| | | | | | Linoleum | 38.143 |
|  | REE6B FourReal® Flex, 240x160 | 81,2 | 8 |  | Decor | 26.405 |
| | | | | | Laminate | 34.999 |
| | | | | | Fenix laminate | 45.159 |
| | | | | | Linoleum | 43.680 |

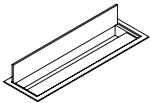
For tabletop cutout placements go to: Oceefour.com/Cutout.pdf

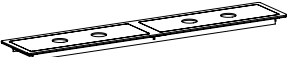
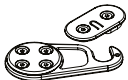
| ACCESSORIES | Description | Weight (Kg) | Dimensions (mm) | Price (SEK) |
|-------------------------------------------------------------------------------------|-----------------------------------------------------------------------------------|-------------|----------------------|-------------|
|  | CABLE NET 620 – ACC1005 | | 620 x H106 mm | 452 |
|  | PAPER ROLL HOLDER – ACC1003 Incl. paper | 2,6 | L535 x W104 xH152 mm | 764 |
|  | 2 X CHAIR SUSPENSION | | | 510 |
|  | 4 X CHAIR SUSPENSION | | | 1020 |
|  | 6 X CHAIR SUSPENSION | | | 1530 |
|  | 8 X CHAIR SUSPENSION | | | 2040 |
|  | CABLE CUT OUT Cable duct, aluminum. Cable duct placed in apron | | | 2.030 |
|  | CD SINGLE CD1 Cable duct, Single, incl., hole in table top. Aluminium | | | 3415 |
|  | CD DOUBLE CD2: Cable duct, double, incl., hole in table top. Aluminium | | | 4183 |
|  | LINKING DEVICE Linking Device, set of 4 pcs - 2 x he, 2 x she per table | | | 525 |



FEATURES

- Table height 90 cm. Angled legs – Integrated castors on two legs.
- With height adjustment glides on the other two legs to aid movement.
- Foldable by one person without use of tools. Matching ABS edges.
- Room In Room & Chair suspension options. Room In Room comes in Decor as standard.
- Electrical units are optional and will be positioned in the centre of tables as standard.



For product information visit oceefour.com ↗

TABLE TOP

Decor



Laminate



Fenix laminate



Linoleum



FRAME COLOURS

Standard



Frame optional*







For electrical accessories [go to page 228](#) ↗

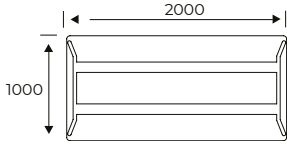

For full colour details [go to page 236](#) ↗

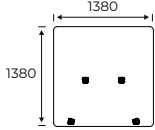
| Product | Description (Item nr) | Weight (Kg) | Chair suspension | Dimensions (mm) | Top/Band | Price (SEK) |
|---------|------------------------------------------------------|-------------|------------------|-----------------|-------------------------------------------------|------------------------------------|
| | 22300 FourReal® 90, 140 x 60, Folding legs | 25.1 | 0 | | Decor Laminate Fenix laminate Linoleum | 7.326 8.440 10.510 11.423 |
| | 22310 FourReal® 90, 140 x 80, Folding legs | 30.2 | 4 | | Decor Laminate Fenix laminate Linoleum | 7.559 8.706 11.313 12.380 |
| | 22380 FourReal® 90, 160 x 80, Folding legs | 30.5 | 4 | | Decor Laminate Fenix laminate Linoleum | 7.941 9.147 12.744 13.578 |
| | 22320 FourReal® 90, 180 x 60, Folding legs | 27.5 | 0 | | Decor Laminate Fenix laminate Linoleum | 7.946 9.154 11.984 12.590 |
| | 22330 FourReal® 90, 180 x 80, Folding legs | 33.1 | 6 | | Decor Laminate Fenix laminate Linoleum | 8.150 9.384 13.515 14.221 |

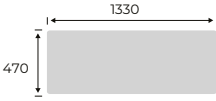
For tabletop cutout placements go to: Oceedesign.com/Cutout.pdf

| Product | Description (Item nr) | Weight (Kg) | Chair suspension | Dimensions (mm) | Top/Band | Price (SEK) |
|-----------------------------------------------------------------------------------|-------------------------------------------------------|-------------|------------------|------------------------------------------------------------------------------------|-------------------------------------------------|----------------------------------------------------|
|  | 22360 FourReal® 90, 200 x 100, Folding legs | 51.4 | 0 |  | Decor Laminate Fenix laminate Linoleum | 11.280 13.214 18.347 19.810 |
|  | 2423 Room in Room, FourReal 90 | 26.4 | - |  | Decor Laminate Fenix laminate Linoleum | 3.502 |
|  | 2430001 Acoustic for RinR, 133 x 47 | 4.8 | - |  | 1 2 3 4 5 6 | 2.852 3.065 3.279 3.503 3.706 3.909 |

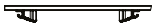
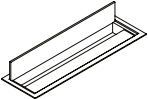
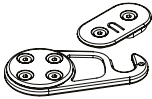
For tabletop cutout placements go to: [Oceedesign.com/Cutout.pdf](https://oceedesign.com/Cutout.pdf)

| ACCESSORIES | Description | Weight (Kg) | Dimensions (mm) | Price (SEK) |
|-------------------------------------------------------------------------------------|-----------------------------------------------------------------------------------------------------------------------------------------------------------------------|-------------|----------------------------------------------------|-------------|
|  | CHAIR SUSPENSION Chair suspension for FourCast2 Four, FourCast2 Line, FourSure 44, FourSure 88, FourSure 11, FourSure 99, Four Stools, Four Seating Benches | 0,3 Kg | | 255 |
|  | CHAIR SUSPENSION Chair suspension for FourCast2 Wheeler, FourSure 66 | 0,3 Kg | | 255 |
|  | CABLE CUT OUT Cable duct, aluminum. Cable duct placed in apron | | | 2.030 |
| | CABLE CUT OUT | | | 711 |
|  | LINKING DEVICE Linking Device, set of 4 pcs - 2 x he, 2 x she per table | | | 525 |
|  | TABLE TROLLEY - 20100001 Trolley for 10 Folded Tables or 7 round tables, including strap | 20 Kg | 1720 mm x 550 mm x 980 mm. Folded Table: 150 mm | 8.773 |
| SURCHARGE | | | | Price (SEK) |
| FRAME OPTIONAL |  6 | | | 382 |



FEATURES

- Table height 105 cm. Angled legs – Integrated castors on two legs.
- Foldable by one person without the use of tools. Matching ABS edges.
- Room In Room & Chair suspension options. Room In Room comes in Decor as standard.
- Electrical units are optional and will be positioned in the centre of tables as standard.



For product information visit oceefour.com ↗

TABLE TOP

Decor



Laminate



Fenix laminate



Linoleum



FRAME COLOURS

Standard



Frame optional*





For electrical accessories [go to page 228](#) ↗

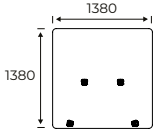

For full colour details [go to page 236](#) ↗

| Product | Description (Item nr) | Weight (Kg) | Chair suspension | Dimensions (mm) | Top/Band | Price (SEK) |
|---------|-------------------------------------------------------|-------------|------------------|-----------------|-------------------------------------------------|------------------------------------|
| | 22400 FourReal® 105, 140 x 60, Folding legs | 26.1 | 0 | | Decor Laminate Fenix laminate Linoleum | 7.323 8.440 10.510 11.423 |
| | 22410 FourReal® 105, 140 x 80, Folding legs | 31.2 | 4 | | Decor Laminate Fenix laminate Linoleum | 7.559 8.706 11.313 12.380 |
| | 22480 FourReal® 105, 160 x 80, Folding legs | 31.5 | 4 | | Decor Laminate Fenix laminate Linoleum | 7.941 9.147 12.744 13.578 |
| | 22420 FourReal® 105, 180 x 60, Folding legs | 28.4 | 0 | | Decor Laminate Fenix laminate Linoleum | 7.946 9.154 11.984 12.590 |
| | 22430 FourReal® 105, 180 x 80, Folding legs | 34.2 | 6 | | Decor Laminate Fenix laminate Linoleum | 8.150 9.384 13.515 14.266 |

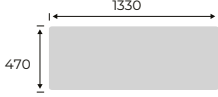
For tabletop cutout placements go to: Oceedesign.com/Cutout.pdf

| Product | Description (Item nr) | Weight (Kg) | Chair suspension | Dimensions (mm) | Top/Band | Price (SEK) |
|----------------------------------------------------------------------------------|-----------------------------------------------|-------------|------------------|------------------------------------------------------------------------------------|-------------------------------------------------|----------------------------------------------------|
|  | 2424 Room in Room, FourReal 105 | 26.4 | - |  | Decor Laminate Fenix laminate Linoleum | 3.502 |
|  | 2430001 Acoustic for RinR, 133 x 47 | 4.8 | - |  | 1 2 3 4 5 6 | 2.852 3.065 3.279 3.503 3.706 3.909 |

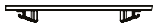
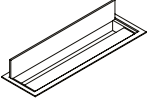
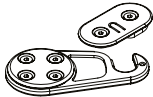
For tabletop cutout placements go to: [Oceedesign.com/Cutout.pdf](https://oceedesign.com/Cutout.pdf)

| ACCESSORIES | Description | Weight (Kg) | Dimensions (mm) | Price (SEK) |
|-------------------------------------------------------------------------------------|-----------------------------------------------------------------------------------------------------------------------------------------------------------------------|-------------|----------------------------------------------------|-------------|
|  | CHAIR SUSPENSION Chair suspension for FourCast2 Four, FourCast2 Line, FourSure 44, FourSure 88, FourSure 11, FourSure 99, Four Stools, Four Seating Benches | 0,3 Kg | | 255 |
|  | CHAIR SUSPENSION Chair suspension for FourCast2 Wheeler, FourSure 66 | 0,3 Kg | | 255 |
|  | CABLE CUT OUT Cable duct, aluminum. Cable duct placed in apron | | | 2.030 |
| | CABLE CUT OUT | | | 711 |
|  | LINKING DEVICE Linking Device, set of 4 pcs - 2 x he, 2 x she per table | | | 525 |
|  | TABLE TROLLEY - 20100001 Trolley for 10 Folded Tables or 7 round tables, including strap | 20 Kg | 1720 mm x 550 mm x 980 mm. Folded Table: 150 mm | 8.773 |

| SURCHARGE | | Price (SEK) |
|-----------------------|------------------------------------------------------------------------------------------|-------------|
| FRAME OPTIONAL |  6 | 382 |



FEATURES

- Table height 74 cm – integrated castors on two legs.
- Matching ABS edges.
- Chair suspension, Flower box & Top-shelf options.
- Powder coated frame options.
- Delivered unassembled.
- Electrical units are optional and will be positioned in the centre of tables as standard.

For product information visit oceefour.com ↗

TABLE TOP

Decor



Laminate



Fenix laminate



Linoleum



FRAME COLOURS

Standard









For electrical accessories [go to page 228](#) ↗

For full colour details [go to page 236](#) ↗

| Product | Description (Item nr) | Weight (Kg) | Chair suspension | Dimensions (mm) | Top | Price (SEK) |
|---------|---------------------------------------------|-------------|------------------|-----------------|-------------------------------------------------|-------------------------------------|
| | 65025 FourReal® A 74, 140 x 80, A | 44,1 | 4 | | Decor Laminate Fenix laminate Linoleum | 9.130 9.961 13.215 14.753 |
| | 65015 FourReal® A 74, 180 x 80, A | 52 | 6 | | Decor Laminate Fenix laminate Linoleum | 9.713 10.921 14.963 15.652 |

For tabletop cutout placements go to: Oceedesign.com/Cutout.pdf

| ACCESSORIES | Description | Weight (Kg) | Dimensions (mm) | Price (SEK) |
|-------------------------------------------------------------------------------------|-----------------------------------------------------------------------------------------------------------------------------------------------------------------------|-------------|-----------------------|-------------|
|  | CHAIR SUSPENSION Chair suspension for FourCast2 Four, FourCast2 Line, FourSure 44, FourSure 88, FourSure 11, FourSure 99, Four Stools, Four Seating Benches | 0,3 Kg | | 255 |
|  | CHAIR SUSPENSION Chair suspension for FourCast2 Wheeler, FourSure 66 | 0,3 Kg | | 255 |
|  | 699000008 Table Accessories, Flower box black, 60 cm | 0,4 Kg | L600 x W160 x H140 mm | 438 |
|  | 699000005 Table Accessories, Flower box black, 80 cm | 0,5 Kg | L800 x W160 x H140 mm | 438 |
|  | 699000001 Table Accessories, Top shelf white, 60 cm x 20,5 cm | 1,5 Kg | 600 x 205 mm | 438 |
|  | 699000002 Table Accessories, Top shelf black, 60 cm x 20,5 cm | 1,5 Kg | 600 x 205 mm | 438 |
|  | 699000003 Table Accessories, Top shelf grey, 60 cm x 20,5 cm | 1,5 Kg | 600 x 205 mm | 438 |



FEATURES

- Table height 74 cm – integrated castors on two legs
- Matching ABS edges.
- Chair suspension, Flower box & Top-shelf options.
- Powder coated frame options.
- Delivered unassembled.
- Electrical units are optional and will be positioned in the centre of tables as standard.

For product information visit oceefour.com ↗

TABLE TOP

Decor



Laminate



Fenix laminate



Linoleum



FRAME COLOURS

Standard



For electrical accessories [go to page 228](#) ↗

For full colour details [go to page 236](#) ↗

| Product | Description (Item nr) | Weight (Kg) | Chair suspension | Dimensions (mm) | Top | Price (SEK) |
|---------|-----------------------------------------------------------|-------------|------------------|-----------------|-------------------------------------------------|--------------------------------------|
| | 65205 FourReal® A XL 74, 180 x 100, A | 69.4 | 6 | | Decor Laminate Fenix laminate Linoleum | 16.268 17.647 20.144 22.468 |
| | 65215 FourReal® A XL 74, 200 x 100, A | 74.4 | 6 | | Decor Laminate Fenix laminate Linoleum | 18.076 19.608 22.381 24.964 |
| | 65225 FourReal® A XL 74, 240 x 100, A | 84.4 | 8 | | Decor Laminate Fenix laminate Linoleum | 20.660 22.364 25.808 28.391 |
| | 65209 FourReal® A XL 74, 180 x 100, A extension | 58.7 | 6 | | Decor Laminate Fenix laminate Linoleum | 13.685 15.063 17.561 19.884 |
| | 65219 FourReal® A XL 74, 200 x 100, A extension | 63.6 | 6 | | Decor Laminate Fenix laminate Linoleum | 15.493 17.214 19.797 22.381 |

For tabletop cutout placements go to: Oceedesign.com/Cutout.pdf





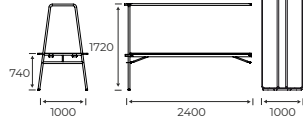

FourReal® A XL 74

Design by Studio Ocee

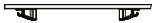
[Content ↗](#)

| Product | Description (Item nr) | Weight (Kg) | Chair suspension | Dimensions (mm) | Top | Price (SEK) |
|----------------------------------------------------------------------------------|-----------------------------------------------------------|-------------|------------------|------------------------------------------------------------------------------------|----------------|-------------|
|  | 65229 FourReal® A XL 74, 240 x 100, A extension | 77.5 | 8 |  | Decor | 18.076 |
| | | | | | Laminate | 19.781 |
| | | | | | Fenix laminate | 23.224 |
| | | | | | Linoleum | 25.808 |

For tabletop cutout placements go to: [Oceedesign.com/Cutout.pdf](https://oceedesign.com/Cutout.pdf)

| ACCESSORIES | Description | Weight (Kg) | Dimensions (mm) | Price (SEK) |
|-------------------------------------------------------------------------------------|-----------------------------------------------------------------------------------------------------------------------------------------------------------------------|-------------|-----------------------|-------------|
|  | CHAIR SUSPENSION Chair suspension for FourCast2 Four, FourCast2 Line, FourSure 44, FourSure 88, FourSure 11, FourSure 99, Four Stools, Four Seating Benches | 0,3 Kg | | 255 |
|  | CHAIR SUSPENSION Chair suspension for FourCast2 Wheeler, FourSure 66 | 0,3 Kg | | 255 |
|  | 699000008 Table Accessories, Flower box black, 60 cm | 0,4 Kg | L600 x W160 x H140 mm | 438 |
|  | 699000005 Table Accessories, Flower box black, 80 cm | 0,5 Kg | L800 x W160 x H140 mm | 438 |
|  | 699000001 Table Accessories, Top shelf white, 60 cm x 20,5 cm | 1,5 Kg | 600 x 205 mm | 438 |
|  | 699000002 Table Accessories, Top shelf black, 60 cm x 20,5 cm | 1,5 Kg | 600 x 205 mm | 438 |
|  | 699000003 Table Accessories, Top shelf grey, 60 cm x 20,5 cm | 1,5 Kg | 600 x 205 mm | 438 |



FEATURES



- Table height 74 cm – integrated castors on two legs
- Optional 25 mm gap between tabletops for accessory mounting
- Personalise with trays, paper rolls, power cubes, acoustic panels and cable nets
- Available with a flower box and top shelf
- Electrical installation option for tabletops without 25 mm gap
- Possibility of chair suspension and to install cable net
- Powder-coated frame colour
- ABS edge matches tabletop colour
- Delivered flat-packed; easy to assemble and install

For product information visit oceefour.com ↗

TABLE TOP

Decor



05 06 07

Laminate



02 03 04

FRAME COLOURS

Standard



01 02 03

Fenix laminate



08 09 10

Linoleum













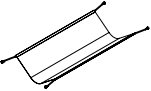
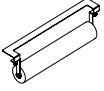

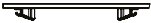
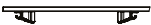
11

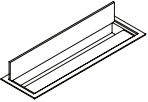
For electrical accessories [go to page 228](#) ↗

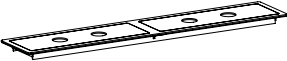
For full colour details [go to page 236](#) ↗

| Product | Description (Item no) | Weight (Kg) | Max Chair suspension | Dimensions (mm) | Top/Band | Price (SEK) |
|---------|------------------------------------------------|-------------|----------------------|-----------------|-------------------------------------------------|--------------------------------------|
| | REF2E1 FourReal® A Flex, 140x120, 74 | 68 | 4 | | Decor Laminate Fenix laminate Linoleum | 17.492 19.573 22.604 25.916 |
| | REF2H1 FourReal® A Flex, 140x140, 74 | 72 | 4 | | Decor Laminate Fenix laminate Linoleum | 18.117 21.837 23.000 27.251 |
| | REF691 FourReal® A Flex, 240x120, 74 | 96,3 | 8 | | Decor Laminate Fenix laminate Linoleum | 26.405 32.677 36.665 40.085 |
| | REF6A1 FourReal® A Flex, 240x140, 74 | 103,2 | 8 | | Decor Laminate Fenix laminate Linoleum | 28.905 35.673 38.572 44.237 |

For tabletop cutout placements go to: [Oceefour.com/Cutout.pdf](https://oceefour.com/Cutout.pdf)

| ACCESSORIES | Description | Weight (Kg) | Dimensions (mm) | Price (SEK) |
|-------------------------------------------------------------------------------------|----------------------------------------------------------------------------------|-------------|-----------------------|-------------|
|  | CABLE NET 620 – ACC1005 | | L620 x H106 mm | 452 |
|  | PAPER ROLL HOLDER – ACC1003 Incl. paper | 2,6 Kg | L535 x W104 x H152 mm | 764 |
|  | 2 X CHAIR SUSPENSION | | | 510 |
|  | 4 X CHAIR SUSPENSION | | | 1020 |
|  | 6 X CHAIR SUSPENSION | | | 1530 |
|  | 8 X CHAIR SUSPENSION | | | 2040 |
|  | CABLE CUT OUT Cable duct, aluminum. Cable duct placed in apron | | | 2.030 |
|  | CD SINGLE CD1 Cable duct, Single, incl., hole in table top. Aluminium | | | 3415 |
|  | CD DOUBLE CD2: Cable duct, double, incl., hole in table top. Aluminium | | | 4183 |
|  | 699000008 Table Accessories, Flower box black, 60 cm | 0,4 Kg | L600 x W160 x H140 mm | 438 |
|  | 699000005 Table Accessories, Flower box black, 80 cm | 0,5 Kg | L800 x W160 x H140 mm | 438 |
|  | 699000001 Table Accessories, Top shelf white, 60 cm x 20,5 cm | 1,5 Kg | 600 x 205 mm | 438 |
|  | 699000002 Table Accessories, Top shelf black, 60 cm x 20,5 cm | 1,5 Kg | 600 x 205 mm | 438 |
|  | 699000003 Table Accessories, Top shelf grey, 60 cm x 20,5 cm | 1,5 Kg | 600 x 205 mm | 438 |

FourReal® A 90

Design by Studio Ocee

[Content ↗](#)



FEATURES

- Table height 90 cm – integrated castors on two legs.
- Matching ABS edges.
- Chair suspension, Flower box & Top-shelf options.
- Powder coated frame options.
- Delivered unassembled.
- Electrical units are optional and will be positioned in the centre of tables as standard.



For product information visit oceefour.com ↗

TABLE TOP

Decor



Laminate



Fenix laminate



Linoleum





FRAME COLOURS

Standard





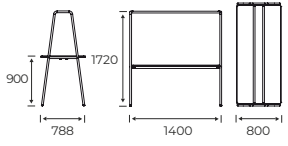



For electrical accessories [go to page 228](#) ↗

For full colour details [go to page 236](#) ↗

| Product | Description (Item nr) | Weight (Kg) | Chair suspension | Dimensions (mm) | Top | Price (SEK) |
|------------------------------------------------------------------------------------|---------------------------------------------|-------------|------------------|--------------------------------------------------------------------------------------|-------------------------------------------------|-------------------------------------|
|  | 65125 FourReal® A 90, 140 x 80, A | 43.8 | 4 |  | Decor Laminate Fenix laminate Linoleum | 9.130 9.961 13.215 14.753 |
|  | 65115 FourReal® A 90, 180 x 80, A | 51.7 | 6 |  | Decor Laminate Fenix laminate Linoleum | 9.713 10.921 14.963 15.652 |

For tabletop cutout placements go to: Oceedesign.com/Cutout.pdf

| ACCESSORIES | Description | Weight (Kg) | Dimensions (mm) | Price (SEK) |
|-------------------------------------------------------------------------------------|-----------------------------------------------------------------------------------------------------------------------------------------------------------------------|-------------|-----------------------|-------------|
|  | CHAIR SUSPENSION Chair suspension for FourCast2 Four, FourCast2 Line, FourSure 44, FourSure 88, FourSure 11, FourSure 99, Four Stools, Four Seating Benches | 0,3 Kg | | 255 |
|  | CHAIR SUSPENSION Chair suspension for FourCast2 Wheeler, FourSure 66 | 0,3 Kg | | 255 |
|  | 699000008 Table Accessories, Flower box black, 60 cm | 0,4 Kg | L600 x W160 x H140 mm | 438 |
|  | 699000005 Table Accessories, Flower box black, 80 cm | 0,5 Kg | L800 x W160 x H140 mm | 438 |
|  | 699000001 Table Accessories, Top shelf white, 60 cm x 20,5 cm | 1,5 Kg | 600 x 205 mm | 438 |
|  | 699000002 Table Accessories, Top shelf black, 60 cm x 20,5 cm | 1,5 Kg | 600 x 205 mm | 438 |
|  | 699000003 Table Accessories, Top shelf grey, 60 cm x 20,5 cm | 1,5 Kg | 600 x 205 mm | 438 |

FourReal® A XL 90

Design by Studio Ocee

[Content ↗](#)



FEATURES

- Table height 90 cm – integrated castors on two legs.
- Matching ABS edges.
- Chair suspension, Flower box & Top-shelf options.
- Powder coated frame options.
- Delivered unassembled.
- Electrical units are optional and will be positioned in the centre of tables as standard.



For product information visit oceefour.com ↗

TABLE TOP

Decor



Laminate



Fenix laminate



Linoleum



FRAME COLOURS

Standard



For electrical accessories [go to page 228](#) ↗

For full colour details [go to page 236](#) ↗

| Product | Description (Item nr) | Weight (Kg) | Chair suspension | Dimensions (mm) | Top | Price (SEK) |
|---------|-----------------------------------------------------------|-------------|------------------|-----------------|-------------------------------------------------|--------------------------------------|
| | 65305 FourReal® A XL 90, 180 x 100, A | 69.1 | 6 | | Decor Laminate Fenix laminate Linoleum | 16.268 17.647 20.144 22.468 |
| | 65315 FourReal® A XL 90, 200 x 100, A | 74.1 | 6 | | Decor Laminate Fenix laminate Linoleum | 18.076 19.608 22.381 24.964 |
| | 65325 FourReal® A XL 90, 240 x 100, A | 84 | 8 | | Decor Laminate Fenix laminate Linoleum | 20.660 22.364 25.808 28.391 |
| | 65309 FourReal® A XL 90, 180 x 100, A extension | 58.5 | 6 | | Decor Laminate Fenix laminate Linoleum | 13.685 15.063 17.561 19.884 |
| | 65319 FourReal® A XL 90, 200 x 100, A extension | 63.5 | 6 | | Decor Laminate Fenix laminate Linoleum | 15.493 17.214 19.797 22.381 |

For tabletop cutout placements go to: Oceedesign.com/Cutout.pdf





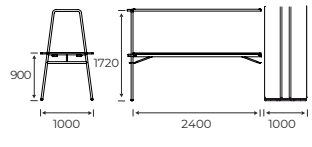

FourReal® A XL 90

Design by Studio Ocee

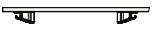
[Content ↗](#)

| Product | Description (Item nr) | Weight (Kg) | Chair suspension | Dimensions (mm) | Top | Price (SEK) |
|----------------------------------------------------------------------------------|-----------------------------------------------------------|-------------|------------------|------------------------------------------------------------------------------------|----------------|-------------|
|  | 65329 FourReal® A XL 90, 240 x 100, A extension | 73.5 | 8 |  | Decor | 18.076 |
| | | | | | Laminate | 19.781 |
| | | | | | Fenix laminate | 23.224 |
| | | | | | Linoleum | 25.808 |

For tabletop cutout placements go to: [Oceedesign.com/Cutout.pdf](https://oceedesign.com/Cutout.pdf)

| ACCESSORIES | Description | Weight (Kg) | Dimensions (mm) | Price (SEK) |
|-------------------------------------------------------------------------------------|-----------------------------------------------------------------------------------------------------------------------------------------------------------------------|-------------|-----------------------|-------------|
|  | CHAIR SUSPENSION Chair suspension for FourCast2 Four, FourCast2 Line, FourSure 44, FourSure 88, FourSure 11, FourSure 99, Four Stools, Four Seating Benches | 0,3 Kg | | 255 |
|  | CHAIR SUSPENSION Chair suspension for FourCast2 Wheeler, FourSure 66 | 0,3 Kg | | 255 |
|  | 699000008 Table Accessories, Flower box black, 60 cm | 0,4 Kg | L600 x W160 x H140 mm | 438 |
|  | 699000005 Table Accessories, Flower box black, 80 cm | 0,5 Kg | L800 x W160 x H140 mm | 438 |
|  | 699000001 Table Accessories, Top shelf white, 60 cm x 20,5 cm | 1,5 Kg | 600 x 205 mm | 438 |
|  | 699000002 Table Accessories, Top shelf black, 60 cm x 20,5 cm | 1,5 Kg | 600 x 205 mm | 438 |
|  | 699000003 Table Accessories, Top shelf grey, 60 cm x 20,5 cm | 1,5 Kg | 600 x 205 mm | 438 |



FEATURES

- Table height 74 cm. Comes with 4 Castors with brakes.
- Foldable by one person without the use of tools
- Matching ABS edges
- Powder coated frame options
- To ensure optimum stability on uneven surfaces we would recommend specifying with adjustable castors
- Delivered unassembled

For product information visit oceefour.com ↗

TABLE TOP

Decor



Laminate



Fenix laminate



FRAME COLOURS









Standard

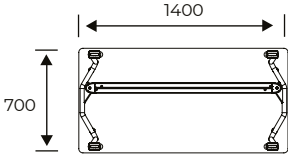

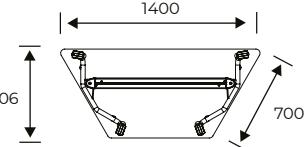

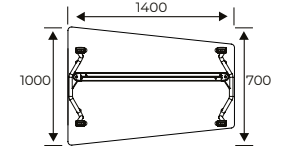

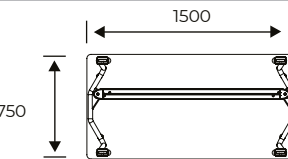
Frame optional*

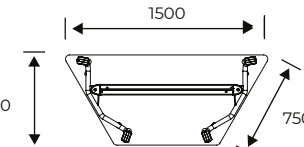

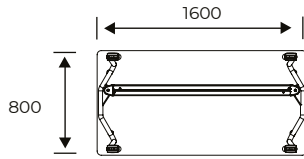
For full colour details [go to page 250](#) ↗

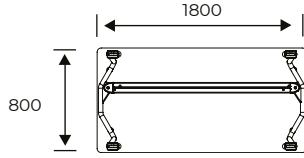
| Product | Description (Item nr) | Weight (Kg) | Dimensions (mm) | Top | Price (SEK) |
|------------------------------------------------------------------------------------|------------------------------------------------------------|-------------|--------------------------------------------------------------------------------------|-------------------------------------|--------------------------|
|  | 66040 FourFold®, 140 x 70, Folding leg | 25.7 |  | Decor Laminate Fenix laminate | 8.056 9.291 12.339 |
|  | 66050 FourFold®, 140 x 70 trapez, Folding leg | 19.9 |  | Decor Laminate Fenix laminate | 8.056 9.291 12.339 |
|  | 66080 FourFold®, 140 x 70-100 Taper, Folding leg | 29.3 |  | Decor Laminate Fenix laminate | 8.589 9.877 13.003 |
|  | 66000 FourFold®, 150 x 75, Folding leg | 28.5 |  | Decor Laminate Fenix laminate | 8.056 9.291 12.339 |
|  | 66010 FourFold®, 150 x 75 trapez, Folding leg | 21.9 |  | Decor Laminate Fenix laminate | 8.056 9.291 12.339 |

| Product | Description (Item nr) | Weight (Kg) | Dimensions (mm) | Top | Price (SEK) |
|----------------------------------------------------------------------------------|--------------------------------------------------|-------------|------------------------------------------------------------------------------------|----------------|-------------|
|  | 66020 FourFold®, 160 x 80, Folding leg | 31.3 |  | Decor | 9.065 |
| | | | | Laminate | 10.787 |
| | | | | Fenix laminate | 14.880 |
|  | 66030 FourFold®, 180 x 80, Folding leg | 34 |  | Decor | 9.670 |
| | | | | Laminate | 11.393 |
| | | | | Fenix laminate | 15.486 |

| ACCESSORIES | Description | Weight (Kg) | Dimensions (mm) | Price (SEK) |
|-----------------------------------------------------------------------------------|---------------------------------------------------------------|-------------|-----------------|-------------|
|  | FEET Height adjustable castors in black with brakes | | | 2.053 |
|  | LOCK Set of 2 | | | 408 |

| SURCHARGE | | Price (SEK) |
|-----------------------|------------------------------------------------------------------------------------------|-------------|
| FRAME OPTIONAL |  6 | 382 |

Acoustic Panels

Design by Studio Ocee

[Content](#) ↗



FEATURES



- Made of 60% recycled PET
- Available in two colors: Anthracite or Light Grey
- Hanging version (only for FourReal® A Flex) has black elastic straps and black steel clips
- Standing version can be mounted in the 25 mm gap on FourReal® Flex/A Flex
- Standing version can also be freestanding and used across all tables
- Trapezium shape complements the FourReal® Family
- Standing panel foot doubles as a device/magazine holder

For product information visit oceefour.com ↗

FELT FINISHES

Standard



For full colour details [go to page 236](#) ↗

| Product | Description (Item no) | Weight (Kg) | Dimensions (mm) | Price (SEK) |
|---------|------------------------------------------------------|-------------|-----------------|-------------|
| | ATAC1661 Acoustic, Standing, 55x44T, Felt | 1,6 | | 1.905 |
| | ATAC3661 Acoustic, Hanging, 55x44T, Felt | 0,98 | | 1.748 |
| | ATAC1671 Acoustic, Standing, 110x44T, Felt | 3,3 | | 2.717 |
| | ATAC3671 Acoustic, Hanging, 110x44T, Felt | 1,9 | | 2.561 |
| | ATAC1681 Acoustic, Standing, 130x44T, Felt | 3,6 | | 2.920 |

Acoustic

Design by Studio Ocee

[Content ↗](#)

| Product | Description (Item no) | Weight (Kg) | Dimensions (mm) | Price (SEK) |
|-----------------------------------------------------------------------------------|-----------------------------------------------------|-------------|------------------------------------------------------------------------------------|-------------|
|  | ATAC3681 Acoustic, Hanging, 130x44T, Felt | 2,2 |  | 2.764 |

| ACCESSORIES | Description | Weight (Kg) | Dimensions (mm) | Price (€) |
|-----------------------------------------------------------------------------------|---------------------------------|-------------|-----------------|-----------|
|  | ACOUSTIC STRAP – ACC1004 | | W50 xH440 mm | 23 |

Tray

Design by Studio Ocee

[Content](#) ↗



FEATURES



- Two shapes: rectangular or circular
- Two heights: 8 cm or 14 cm
- Two finishes: natural oak or black oak veneer (70% FSC mix)
- Can be freestanding with a round steel foot
- Can be mounted in the 25 mm gap on FourReal Flex/A Flex
- Standing trays can be used across all products in our FourReal® Family
- Delivered flat-packed; easy to assemble and install

For product information visit oceefour.com ↗

COLOUR

Veneer









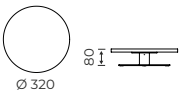

FRAME COLOURS

Standard

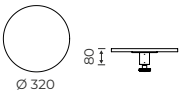

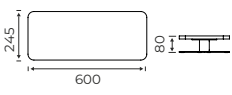
01

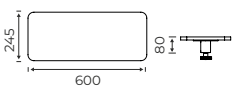

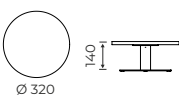

For full colour details [go to page 236](#) ↗

| Product | Description (Item no) | Weight (Kg) | Dimensions (mm) | Top | Price (SEK) |
|-------------------------------------------------------------------------------------|-------------------------------------------------------|-------------|--------------------------------------------------------------------------------------|--------|-------------|
|  | ATTR1641 Tray, Standing, Ø32, Height 80 | 2,7 |  | Veneer | 1.577 |
|  | ATTR2641 Tray, Fixed, Ø32, Height 80 | 1,3 |  | Veneer | 1.264 |
|  | ATTR1651 Tray, Standing, 60x24.5, Height 80 | 3,3 |  | Veneer | 1.827 |
|  | ATTR2651 Tray, Fixed, 60x24.5, Height 80 | 1,9 |  | Veneer | 1.514 |
|  | ATTR1642 Tray, Standing, Ø32, Height 140 | 2,9 |  | Veneer | 1.592 |

Tray

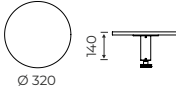
Design by Studio Ocee

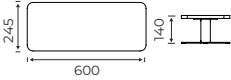
[Content ↗](#)

| Product | Description (Item no) | Weight (Kg) | Dimensions (mm) | Top | Price (SEK) |
|-----------------------------------------------------------------------------------|--------------------------------------------------------|-------------|------------------------------------------------------------------------------------|--------|-------------|
|  | ATTR2642 Tray, Fixed, Ø32, Height 140 | 1,4 |  | Veneer | 1.280 |
|  | ATTR1652 Tray, Standing, 60x24.5, Height 140 | 3,4 |  | Veneer | 1.842 |
|  | ATTR2652 Tray, Fixed, 60x24.5, Height 140 | 2 |  | Veneer | 1.530 |

Power Cube

Design by Studio Ocee

[Content](#) ↗



FEATURES

- Wooden power cube with Evoline ONE unit
- Power socket available in white or black
- USB A+C unit available in white or black
- GST18 socket
- 3 m black cord
- Cube available in natural or black solid oak
- 70% FSC mix

For product information visit oceefour.com ↗

COLOUR

Standard





UNIT COLOURS

Standard

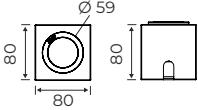

For full colour details [go to page 236](#) ↗

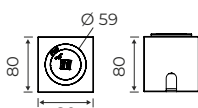
| Product | Description (Item no) | Weight (Kg) | Dimensions (mm) | Colour | Price (SEK) |
|------------------------------------------------------------------------------------|----------------------------------------|-------------|--------------------------------------------------------------------------------------|-----------|-------------|
|  | APOW01 Power Cube, Power A16 | 1,05 |  | Solid oak | 1.639 |
|  | APOW02 Power Cube, USB A+C | 1,05 |  | Solid oak | 2.342 |





FEATURES

- Table height 72,5 cm – integrated castors on two legs.
- With height adjustment glides on the other two legs to aid movement.
- Foldable by one person without the use of tools (thickness of folded table 15 cm).
- Matching ABS edges. Powder coated frame options.
- Electrical units are optional.



For product information visit oceefour.com ↗

TABLE TOP

Decor



Laminate



Fenix laminate



Linoleum





FRAME COLOURS

Standard





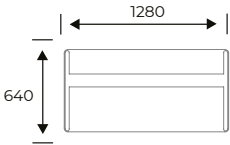

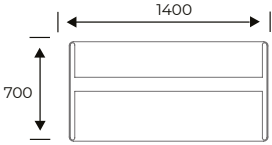
For electrical accessories [go to page 228](#) ↗

For full colour details [go to page 236](#) ↗

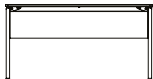
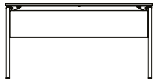
| Product | Description (Item nr) | Weight (Kg) | Chair suspension | Dimensions (mm) | Top | Price (SEK) |
|------------------------------------------------------------------------------------|--------------------------------------------------------|-------------|------------------|--------------------------------------------------------------------------------------|-------------------------------------------------|------------------------------------|
|  | 11630 Four® Learning, 128 x 64, Folding legs | 22.5 | 2 |  | Decor Laminate Fenix laminate Linoleum | 7.012 7.866 9.679 11.511 |
|  | 11610 Four® Learning, 140 x 70, Folding legs | 25.9 | 2 |  | Decor Laminate Fenix laminate Linoleum | 7.215 8.233 10.493 11.879 |

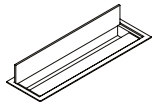
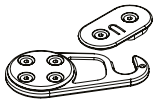
For tabletop cutout placements go to: Oceedesign.com/Cutout.pdf

| ACCESSORIES | Description | Weight (Kg) | Dimensions (mm) | Price (SEK) |
|-------------------------------------------------------------------------------------|-----------------------------------------------------------------------------------------------------------------------------------------------------------------------|-------------|----------------------------------------------------|-------------|
|  | MODESTY PANEL White | | | 1.314 |
|  | MODESTY PANEL Black | | | 1.314 |
|  | CHAIR SUSPENSION Chair suspension for FourCast2 Four, FourCast2 Line, FourSure 44, FourSure 88, FourSure 11, FourSure 99, Four Stools, Four Seating Benches | 0,3 Kg | | 255 |
|  | CHAIR SUSPENSION Chair suspension for FourCast2 Wheeler, FourSure 66 | 0,3 Kg | | 255 |
|  | CABLE CUT OUT Cable duct, aluminum. Cable duct placed in apron | | | 2.030 |
| | CABLE CUT OUT | | | 711 |
|  | LINKING DEVICE Linking Device, set of 4 pcs - 2 x he, 2 x she per table | | | 525 |
|  | TABLE TROLLEY - 20100001 Trolley for 10 Folded Tables or 7 round tables, including strap | 20 Kg | 1720 mm x 550 mm x 980 mm. Folded Table: 150 mm | 8.773 |



FEATURES

- Table height 72,5 cm – integrated castors on two legs with height adjustment.
- With height adjustment glides on the other two legs to aid movement.
- Foldable by one person without the use of tools.
- Matching ABS edges. Powder coated frame options.
- Electrical units are optional and will be positioned in the centre of tables as standard.



For product information visit oceefour.com ↗

TABLE TOP

Decor



Laminate



Fenix laminate



Linoleum



FRAME COLOURS

Standard



For electrical accessories [go to page 228](#) ↗

For full colour details [go to page 236](#) ↗

| Product | Description (Item nr) | Weight (Kg) | Chair suspension | Dimensions (mm) | Top | Price (SEK) |
|---------|------------------------------------------------------------------------|-------------|------------------|-----------------|-------------------------------------------------|------------------------------------|
| | 120E0 Four® Eating, 80 x 80 with 80 x 70 frame, Folding legs | 17.9 | 2 | | Decor Laminate Fenix laminate Linoleum | 5.247 7.103 8.551 10.085 |
| | 12000 Four® Eating, 120 x 80, Folding legs | 23.4 | 4 | | Decor Laminate Fenix laminate Linoleum | 7.104 8.116 10.265 11.630 |
| | 12050 Four® Eating, 140 x 80, Folding legs | 28.4 | 4 | | Decor Laminate Fenix laminate Linoleum | 7.397 8.476 11.137 12.285 |
| | 12040 Four® Eating, 160 x 80, Folding legs | 31.4 | 4 | | Decor Laminate Fenix laminate Linoleum | 7.672 9.048 11.984 12.741 |
| | 12010 Four® Eating, 180 x 80, Folding legs | 34.3 | 6 | | Decor Laminate Fenix laminate Linoleum | 7.968 9.417 12.855 13.171 |

For tabletop cutout placements go to: Oceedesign.com/Cutout.pdf



Four® Eating

Design by Strand+Hvass

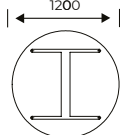
[Content ↗](#)

| Product | Description (Item nr) | Weight (Kg) | Chair suspension | Dimensions (mm) | Top | Price (SEK) |
|----------------------------------------------------------------------------------|---------------------------------------------------|-------------|---------------------|------------------------------------------------------------------------------------|----------------|-------------|
|  | 12020 Four® Eating, Ø 120, Folding legs | 24.9 | 2 |  | Decor | 7.735 |
| | | | | | Laminate | 9.017 |
| | | | | | Fenix laminate | 12.345 |
| | | | | | Linoleum | 13.861 |

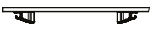
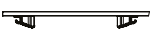
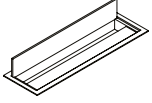
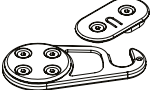
For tabletop cutout placements go to: [Oceedesign.com/Cutout.pdf](https://oceedesign.com/Cutout.pdf)

| ACCESSORIES | Description | Weight (Kg) | Dimensions (mm) | Price (SEK) |
|-------------------------------------------------------------------------------------|-----------------------------------------------------------------------------------------------------------------------------------------------------------------------|-------------|----------------------------------------------------|-------------|
|  | CHAIR SUSPENSION Chair suspension for FourCast2 Four, FourCast2 Line, FourSure 44, FourSure 88, FourSure 11, FourSure 99, Four Stools, Four Seating Benches | 0,3 Kg | | 255 |
|  | CHAIR SUSPENSION Chair suspension for FourCast2 Wheeler, FourSure 66 | 0,3 Kg | | 255 |
|  | CABLE CUT OUT Cable duct, aluminum. Cable duct placed in apron | | | 2.030 |
| | CABLE CUT OUT | | | 711 |
|  | LINKING DEVICE Linking Device, set of 4 pcs - 2 x he, 2 x she per table | | | 525 |
|  | TABLE TROLLEY - 20100001 Trolley for 10 Folded Tables or 7 round tables, including strap | 20 Kg | 1720 mm x 550 mm x 980 mm. Folded Table: 150 mm | 8.773 |

Four® Meeting

Design by Strand+Hvass

[Content ↗](#)



FEATURES

- Table height 72,5 cm – integrated castors on two legs.
- With height adjustment glides on the other two legs to aid movement.
- Foldable by one person without the use of tools (thickness of folded table 15 cm).
- Matching ABS edges. Powder coated frame options.
- Electrical units are optional and will be positioned in the centre of tables as standard.



For product information visit oceefour.com ↗

TABLE TOP

FRAME COLOURS

Standard



Laminate







Fenix laminate



Linoleum

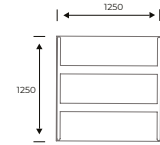

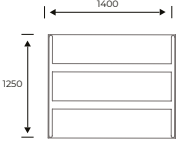
For full colour details [go to page 236](#) ↗

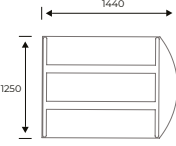

| Product | Description (Item nr) | Weight (Kg) | Chair suspension | Dimensions (mm) | Top | Price (SEK) |
|------------------------------------------------------------------------------------|----------------------------------------------------------------|-------------|------------------|--------------------------------------------------------------------------------------|----------------------------------------|----------------------------|
|  | 11730 Four® Meeting, 125 x 125, Folding legs | 42.1 | 4 |  | Laminate Fenix laminate Linoleum | 13.486 18.061 19.362 |
|  | 11750 Four® Meeting, 125 x 140, Folding legs | 45.7 | 4 |  | Laminate Fenix laminate Linoleum | 14.218 18.602 19.881 |
|  | 11740 Four® Meeting, 125 x 144 D-shape, Folding legs | 39.1 | 4 |  | Laminate Fenix laminate Linoleum | 14.797 19.077 20.317 |

For tabletop cutout placements go to: Oceedesign.com/Cutout.pdf

Four® Meeting

Design by Strand+Hvass

[Content ↗](#)

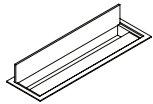
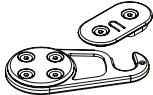
| ACCESSORIES | Description | Weight (Kg) | Dimensions (mm) | Price (SEK) |
|-----------------------------------------------------------------------------------|-----------------------------------------------------------------------------------------------------------------------------------------------------------------------|-------------|-----------------|-------------|
|  | CHAIR SUSPENSION Chair suspension for FourCast2 Four, FourCast2 Line, FourSure 44, FourSure 88, FourSure 11, FourSure 99, Four Stools, Four Seating Benches | 0,3 Kg | | 255 |
|  | CHAIR SUSPENSION Chair suspension for FourCast2 Wheeler, FourSure 66 | 0,3 Kg | | 255 |
|  | CABLE CUT OUT Cable duct, aluminum. Cable duct placed in apron | | | 2.030 |
| | CABLE CUT OUT | | | 711 |
|  | LINKING DEVICE Linking Device, set of 4 pcs - 2 x he, 2 x she per table | | | 525 |

Four® Standing

Design by Strand+Hvass

[Content ↗](#)



FEATURES

- Table height 90 & 103 cm
- Integrated castors on two legs
- Powder coated frame options
- Matching ABS edges

For product information visit oceefour.com ↗

TABLE TOP

Decor



Laminate



Fenix laminate



Linoleum



FRAME COLOURS

Standard



For full colour details [go to page 236](#) ↗





| Product | Description (Item nr) | Weight (Kg) | Dimensions (mm) | Top | Price (SEK) |
|---------|--------------------------------------------------|-------------|-----------------|-------------------------------------------------|--------------------------------------|
| | 12323 Four® Standing, 140 x 60, 90 cm | 28.2 | | Decor Laminate Fenix laminate Linoleum | 12.429 13.446 16.095 18.294 |
| | 12383 Four® Standing, 140 x 80, 90 cm | 36.7 | | Decor Laminate Fenix laminate Linoleum | 13.775 15.065 18.726 20.136 |
| | 12313 Four® Standing, 180 x 60, 90 cm | 35.1 | | Decor Laminate Fenix laminate Linoleum | 12.696 14.069 18.420 19.055 |
| | 12393 Four® Standing, 180 x 80, 90 cm | 43.1 | | Decor Laminate Fenix laminate Linoleum | 14.069 15.815 20.403 20.815 |
| | 12322 Four® Standing, 140 x 60, 103 cm | 29.1 | | Decor Laminate Fenix laminate Linoleum | 12.429 13.446 16.095 18.294 |

For tabletop cutout placements go to: Oceedesign.com/Cutout.pdf

Four® Standing

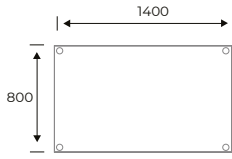
Design by Strand+Hvass

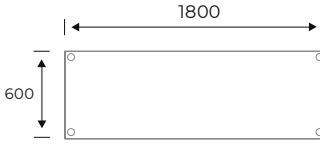
[Content ↗](#)

| Product | Description (Item nr) | Weight (Kg) | Dimensions (mm) | Top | Price (SEK) |
|----------------------------------------------------------------------------------|--------------------------------------------------|-------------|------------------------------------------------------------------------------------|----------------|-------------|
|  | 12382 Four® Standing, 140 x 80, 103 cm | 37.6 |  | Decor | 13.775 |
| | | | | Laminate | 15.065 |
| | | | | Fenix laminate | 18.726 |
| | | | | Linoleum | 20.136 |
|  | 12312 Four® Standing, 180 x 60, 103 cm | 35.9 |  | Decor | 12.696 |
| | | | | Laminate | 14.069 |
| | | | | Fenix laminate | 18.420 |
| | | | | Linoleum | 19.055 |
|  | 12392 Four® Standing, 180 x 80, 103 cm | 44 |  | Decor | 14.069 |
| | | | | Laminate | 15.815 |
| | | | | Fenix laminate | 20.403 |
| | | | | Linoleum | 20.815 |

For tabletop cutout placements go to: [Oceedesign.com/Cutout.pdf](https://oceedesign.com/Cutout.pdf)





FEATURES

- Table height 51, 64, 72 & 103 cm
- Aluminium pedestal 4 and 5-star base
- Castors to table height 51 cm, 64 cm and 72 cm + 5 cm. in height.
- Matching ABS edges
- Powder coated frame options

For product information visit oceefour.com ↗

TABLE TOP

Decor



Laminate



Fenix laminate



Linoleum



FRAME COLOURS

Standard



Frame optional*



For full colour details [go to page 236](#) ↗





















| Product | Description (Item nr) | Weight (Kg) | Dimensions (mm) | Top | Price (SEK) |
|---------|------------------------------------------------------------|-------------|-----------------|----------------|-------------|
| | 12240 Four® Resting, Ø 60, 51 cm - 4 Star base | 9.3 | Ø 600 | Decor | 5.103 |
| | | | | Laminate | 6.128 |
| | | | | Fenix laminate | 7.325 |
| | | | | Linoleum | 8.277 |
| | 12243 Four® Resting, Ø 60, 64 cm - 4 Star base | 9.6 | Ø 600 | Decor | 5.336 |
| | | | | Laminate | 6.370 |
| | | | | Fenix laminate | 7.555 |
| | | | | Linoleum | 8.518 |
| | 12241 Four® Resting, Ø 60, 72,5 cm - 4 Star base | 9.9 | Ø 600 | Decor | 5.336 |
| | | | | Laminate | 6.370 |
| | | | | Fenix laminate | 7.555 |
| | | | | Linoleum | 8.518 |
| | 12242 Four® Resting, Ø 60, 103 cm - 4 Star base | 10.7 | Ø 600 | Decor | 5.528 |
| | | | | Laminate | 6.559 |
| | | | | Fenix laminate | 7.743 |
| | | | | Linoleum | 8.718 |
| | 12250 Four® Resting, Ø 70, 51 cm - 4 Star base | 10.9 | Ø 700 | Decor | 5.214 |
| | | | | Laminate | 6.450 |
| | | | | Fenix laminate | 7.937 |
| | | | | Linoleum | 8.960 |

For tabletop cutout placements go to: Ocedesign.com/Cutout.pdf

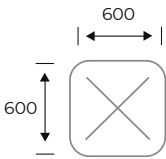
Four® Resting

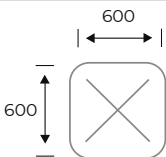
Design by Strand+Hvass

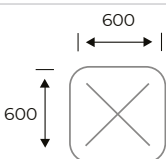
[Content ↗](#)

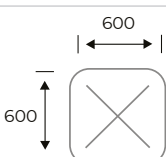









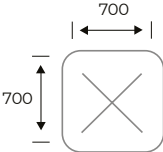

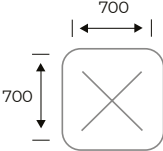

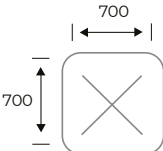

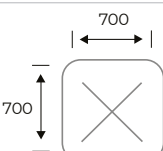

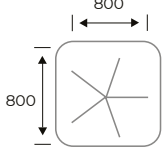

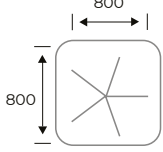
| Product | Description (Item nr) | Weight (Kg) | Dimensions (mm) | Top | Price (SEK) |
|------------------------------------------------------------------------------------|---------------------------------------------------------------|-------------|---------------------------------------------------------------------------------------------------|----------------|-------------|
|  | 12253 Four® Resting, Ø 70, 64 cm - 4 Star base | 11.2 |  Ø 700 | Decor | 5.466 |
| | | | | Laminate | 6.669 |
| | | | | Fenix laminate | 8.158 |
| | | | | Linoleum | 9.194 |
|  | 12251 Four® Resting, Ø 70, 72,5 cm - 4 Star base | 11.4 |  Ø 700 | Decor | 5.466 |
| | | | | Laminate | 6.669 |
| | | | | Fenix laminate | 8.158 |
| | | | | Linoleum | 9.194 |
|  | 12252 Four® Resting, Ø 70, 103 cm - 4 Star base | 12.2 |  Ø 700 | Decor | 5.647 |
| | | | | Laminate | 6.871 |
| | | | | Fenix laminate | 8.349 |
| | | | | Linoleum | 9.384 |
|  | 12265 Four® Resting, Ø 80, 51 cm - 5 Star base | 12.9 |  Ø 800 | Decor | 5.365 |
| | | | | Laminate | 6.792 |
| | | | | Fenix laminate | 8.607 |
| | | | | Linoleum | 9.323 |
|  | 12268 Four® Resting, Ø 80, 64 cm - 5 Star base | 13.2 |  Ø 800 | Decor | 5.594 |
| | | | | Laminate | 7.025 |
| | | | | Fenix laminate | 8.830 |
| | | | | Linoleum | 9.545 |
|  | 12266 Four® Resting, Ø 80, 72,5 cm - 5 Star base | 13.4 |  Ø 800 | Decor | 5.594 |
| | | | | Laminate | 7.025 |
| | | | | Fenix laminate | 8.830 |
| | | | | Linoleum | 9.545 |
|  | 12267 Four® Resting, Ø 80, 103 cm - 5 Star base | 14.2 |  Ø 800 | Decor | 5.807 |
| | | | | Laminate | 7.212 |
| | | | | Fenix laminate | 9.029 |
| | | | | Linoleum | 9.747 |
|  | 12230 Four® Resting, 60 x 60, 51 cm - 4 Star base | - |  600 x 600 | Decor | 5.103 |
| | | | | Laminate | 6.128 |
| | | | | Fenix laminate | 7.325 |
| | | | | Linoleum | 8.277 |
|  | 12233 Four® Resting, 60 x 60, 64 cm - 4 Star base | 10.7 |  600 x 600 | Decor | 5.336 |
| | | | | Laminate | 6.370 |
| | | | | Fenix laminate | 7.555 |
| | | | | Linoleum | 8.518 |
|  | 12231 Four® Resting, 60 x 60, 72,5 cm - 4 Star base | 11 |  600 x 600 | Decor | 5.336 |
| | | | | Laminate | 6.370 |
| | | | | Fenix laminate | 7.555 |
| | | | | Linoleum | 8.518 |
|  | 12232 Four® Resting, 60 x 60, 103 cm - 4 Star base | 11.8 |  600 x 600 | Decor | 5.528 |
| | | | | Laminate | 6.559 |
| | | | | Fenix laminate | 7.743 |
| | | | | Linoleum | 8.718 |

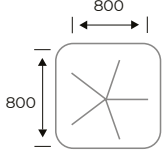
For tabletop cutout placements go to: [Oceedesign.com/Cutout.pdf](https://oceedesign.com/Cutout.pdf)

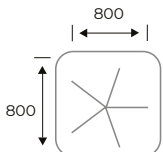
Four® Resting

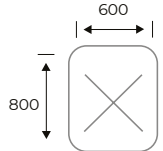
Design by Strand+Hvass

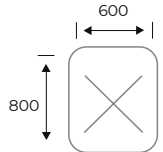
[Content](#) ↗

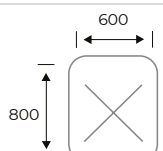
| Product | Description (Item nr) | Weight (Kg) | Dimensions (mm) | Top | Price (SEK) |
|-------------------------------------------------------------------------------------|---------------------------------------------------------------|-------------|--------------------------------------------------------------------------------------|----------------|-------------|
|  | 12200 Four® Resting, 70 x 70, 51 cm - 4 Star base | - |  | Decor | 5.214 |
| | | | | Laminate | 6.450 |
| | | | | Fenix laminate | 7.937 |
| | | | | Linoleum | 8.960 |
|  | 12203 Four® Resting, 70 x 70, 64 cm - 4 Star base | - |  | Decor | 5.466 |
| | | | | Laminate | 6.669 |
| | | | | Fenix laminate | 8.158 |
| | | | | Linoleum | 9.194 |
|  | 12201 Four® Resting, 70 x 70, 72,5 cm - 4 Star base | 13 |  | Decor | 5.466 |
| | | | | Laminate | 6.669 |
| | | | | Fenix laminate | 8.158 |
| | | | | Linoleum | 9.194 |
|  | 12202 Four® Resting, 70 x 70, 103 cm - 4 Star base | 13.8 |  | Decor | 5.647 |
| | | | | Laminate | 6.871 |
| | | | | Fenix laminate | 8.349 |
| | | | | Linoleum | 9.384 |
|  | 12215 Four® Resting, 80 x 80, 51 cm - 5 Star base | 15 |  | Decor | 5.365 |
| | | | | Laminate | 6.792 |
| | | | | Fenix laminate | 8.607 |
| | | | | Linoleum | 9.323 |
|  | 12218 Four® Resting, 80 x 80, 64 cm - 5 Star base | 15.2 |  | Decor | 5.594 |
| | | | | Laminate | 7.025 |
| | | | | Fenix laminate | 8.830 |
| | | | | Linoleum | 9.545 |
|  | 12216 Four® Resting, 80 x 80, 72,5 cm - 5 Star base | 15.5 |  | Decor | 5.594 |
| | | | | Laminate | 7.025 |
| | | | | Fenix laminate | 8.830 |
| | | | | Linoleum | 9.545 |
|  | 12217 Four® Resting, 80 x 80, 103 cm - 5 Star base | 16.3 |  | Decor | 5.807 |
| | | | | Laminate | 7.212 |
| | | | | Fenix laminate | 9.029 |
| | | | | Linoleum | 9.747 |
|  | 12220 Four® Resting, 80 x 60, 51 cm - 4 Star base | 12.3 |  | Decor | 5.214 |
| | | | | Laminate | 6.450 |
| | | | | Fenix laminate | 7.925 |
| | | | | Linoleum | 8.578 |
|  | 12223 Four® Resting, 80 x 60, 64 cm - 4 Star base | 12.6 |  | Decor | 5.466 |
| | | | | Laminate | 6.669 |
| | | | | Fenix laminate | 8.146 |
| | | | | Linoleum | 8.821 |
|  | 12221 Four® Resting, 80 x 60, 72,5 cm - 4 Star base | 12.8 |  | Decor | 5.466 |
| | | | | Laminate | 6.669 |
| | | | | Fenix laminate | 8.146 |
| | | | | Linoleum | 8.821 |

For tabletop cutout placements go to: Ocedesign.com/Cutout.pdf

Four® Resting

Design by Strand+Hvass

[Content ↗](#)

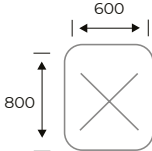
| Product | Description (Item nr) | Weight (Kg) | Dimensions (mm) | Top | Price (SEK) |
|----------------------------------------------------------------------------------|--------------------------------------------------------------|-------------|------------------------------------------------------------------------------------|----------------|-------------|
|  | 12222 Four® Resting, 80 x 60, 103 cm - 4 Star base | - |  | Decor | 5.655 |
| | | | | Laminate | 6.861 |
| | | | | Fenix laminate | 8.357 |
| | | | | Linoleum | 9.001 |

For tabletop cutout placements go to: [Oceedesign.com/Cutout.pdf](https://oceedesign.com/Cutout.pdf)

| ACCESSORIES | Description | Weight (Kg) | Dimensions (mm) | Price (SEK) |
|-------------|-----------------------------------------------------------------|-------------|-----------------|-------------|
| | CHAIR FEET Castors | | | 651 |
| | CHAIR FEET Felt glides, set of 4 pcs. height + 0,2 cm | 1,82 g x 4 | | 208 |
| | FLIP TOP With Flip Top | | | 2.730 |

| SURCHARGE | | Price (SEK) |
|-----------------------|----------------------------------------------------------------------------------------------|-------------|
| FRAME OPTIONAL |  B C K | 1075 |

Y-Table

Design by Osko + Deichmann

[Content](#) ↗



FEATURES

- Height adjustable
- Fold-away allows for nesting storage
- Designed for disassembly at end of life
- Cable management hook
- Height lever doubles up as a handle for portability
- Designed to complement products across all our families
- Tested according to EN 16139, L2 and EN15372 for stability

For product information visit oceefour.com ↗

TABLE TOP

Fenix laminate



09

FRAME COLOURS

Standard



B

For full colour details [go to page 236](#) ↗

| Product | Description (Item nr) | Weight (Kg) | Dimensions (mm) | Top | Price (SEK) |
|---------|-----------------------------------------|-------------|-----------------|----------------|-------------|
| | ATYT63 Y-Table, 46 cm x 33 cm | 4.6 | | Fenix laminate | 4.103 |





FourPeople Stand Alone



FourPeople Stand Alone for panels



FourPeople Modules



FourPeople Modules for panels



FourPeople Stand alone panels



FourPeople Add on panels



FourPeople Work Booth



FourPeople Study Booth



FourPeople Work Hut



FourPeople Sofa Hut

FourPeople Stand Alone

Design by Nørgaard Design

[Content ↗](#)

Configuration Example 1

2 seater
Low back with armrest



1 seater
Low back



2 seater
Low back



3 seater
Low back



Pouf

FourPeople Stand Alone

Design by Nørgaard Design

[Content ↗](#)



FEATURES



- Soft seating range with low back and high back options.
- The range includes one, two, three seater sofas and Pouffe.
- Two tone fabric options available & armrest option.
- Electrical units are optional and will be positioned on the left or right side of sofas as standard.
- Leg and frame in black (RAL7021).
- Upholstery available in various fabrics. For recommendations, please contact your sales representative.

For product information visit oceefour.com ↗

For electrical accessories [go to page 228](#) ↗





For full band and colour details [go to page 338](#) ↗

| Product | Description (Item nr) | Weight (Kg) | Dimensions (mm) | Band | Same colour (SEK) | Different seat colour (SEK) |
|---------|-------------------------------------------------------------|-------------|-----------------|---------------------------------|--------------------------------------------------------------------|-------------------------------------------------------------|
| | PEF1L FourPeople Stand Alone, 1 Seater, Low back | | | 1 2 3 4 5 6 7 | 12.040 12.490 12.962 13.983 14.455 14.807 16.021 | 2.409 2.498 2.592 2.796 2.891 2.962 3.205 |
| | PEF1H FourPeople Stand Alone, 1 Seater, High back | | | 1 2 3 4 5 6 7 | 13.861 14.407 14.990 16.264 16.847 17.284 18.788 | 2.409 2.498 2.592 2.796 2.891 2.962 3.474 |
| | PEF2L FourPeople Stand Alone, 2 Seater, Low back | | | 1 2 3 4 5 6 7 | 18.885 19.225 19.809 21.083 21.665 22.102 23.607 | 3.777 3.846 3.962 4.217 4.333 4.421 4.722 |
| | PEF2H FourPeople Stand Alone, 2 Seater, High back | | | 1 2 3 4 5 6 7 | 21.629 22.539 23.510 25.610 26.580 27.296 29.773 | 3.777 3.846 3.962 4.217 4.333 4.421 4.722 |

FourPeople Stand Alone

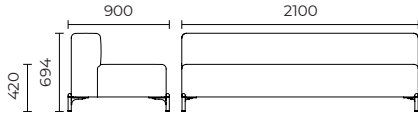
[Content ↗](#)

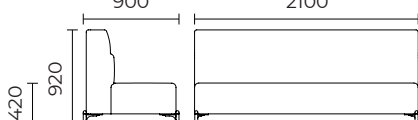
Design by Nørgaard Design

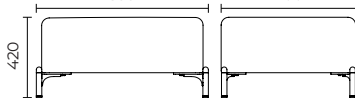
| Product | Description (Item nr) | Weight (Kg) | Dimensions (mm) | Band | Same colour (SEK) | Different seat colour (SEK) |
|----------------------------------------------------------------------------------|-------------------------------------------------------------|-------------|------------------------------------------------------------------------------------|---------------------------------|--------------------------------------------------------------------|-------------------------------------------------------------|
|  | PEF3L FourPeople Stand Alone, 3 Seater, Low back | |  | 1 2 3 4 5 6 7 | 26.957 27.976 29.057 31.399 32.479 33.280 36.047 | 5.392 5.595 5.811 6.280 6.496 6.657 7.210 |
|  | PEF3H FourPeople Stand Alone, 3 Seater, High back | |  | 1 2 3 4 5 6 7 | 31.242 32.491 33.827 36.703 38.025 39.009 42.420 | 5.392 5.595 5.811 6.280 6.496 6.657 7.210 |
|  | PEFP0 FourPeople Stand Alone, Pouf | |  | 1 2 3 4 5 6 7 | 9.795 10.147 10.535 11.361 11.748 12.028 13.011 | |

| ACCESSORIES | Description | Weight (Kg) | Dimensions (mm) | Band | Price (SEK) |
|-------------------------------------------------------------------------------------|--------------------------------|-------------|--------------------|---------------------------------|-------------------------------------------------------------|
|  | Set of armrests | | 800 x 486 x 134 mm | 1 2 3 4 5 6 7 | 3.568 4.170 4.825 6.209 6.847 7.318 8.976 |
|  | FOURPEOPLE TRAY ACC1002 | 1,8 kg | | | 478 |



FourPeople Stand Alone for Panels

[Content ↗](#)

Design by Nørgaard Design

Configuration Example 1

2 seater low back with
back panel with straps,
H1020



1 seater
Low back



2 seater
Low back



3 seater
Low back



Open Panel

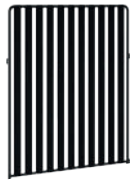

Panel with straps



Panel with fabric



Panel Fabric
with Acoustic

FourPeople Stand Alone for panels

[Content](#) ↗

Design by Nørgaard Design



FEATURES





- Soft seating range with panels. The range includes one, two and three seater sofas.
- Two tone fabric options available.
- A wide selection of panels in a range of heights and widths.
- Panel Options: Open panel, Panel with straps, Fabric Panel, Fabric Panel with Acoustic Filling.
- Armrest option (cannot combine armrest and side panels on the same side).
- Electrical units are optional and will be positioned on the left or right side of sofas as standard.
- Upholstery available in various fabrics. For recommendations, please contact your sales representative.

For product information visit oceefour.com ↗

For electrical accessories [go to page 228](#) ↗

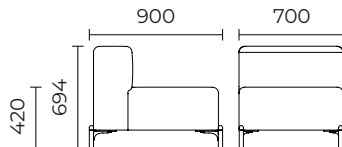
For full band and colour details [go to page 238](#) ↗

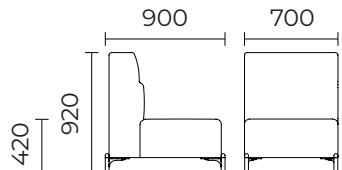

| Product | Description (Item nr) | Weight (Kg) | Dimensions (mm) | Band | Same colour (SEK) | Different seat colour (SEK) |
|-------------------------------------------------------------------------------------|----------------------------------------------------------------------------|-------------|--------------------------------------------------------------------------------------|---------------------------------|--------------------------------------------------------------------|-------------------------------------------------------------|
|  | PEE1L FourPeople Stand Alone for back panel, 1 Seater, Low back | |  | 1 2 3 4 5 6 7 | 12.040 12.490 12.962 13.983 14.455 14.807 16.021 | 2.409 2.498 2.592 2.796 2.891 2.962 3.205 |
|  | PEE1H FourPeople Stand Alone for back panel, 1 Seater, High back | |  | 1 2 3 4 5 6 7 | 13.861 14.407 14.990 16.264 16.847 17.284 18.788 | 2.409 2.498 2.592 2.796 2.891 2.962 3.474 |

FourPeople Stand Alone for panels

Content ↗

Design by Nørgaard Design

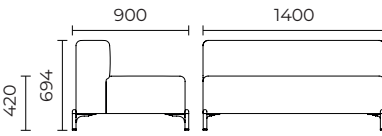
| SURCHARGE | Open panel | | Panel / Straps | | Panel / Fabric | | | Acoustic | | Armrest |
|-----------|------------|----------|----------------|----------|----------------|--------|----------|----------|----------|---------|
| | Back | 1 x Side | Back | 1 x Side | Band | Back | 1 x Side | Back | 1 x Side | 1 x |
| H: 1020 | 3.447 | 4.224 | 4.321 | 5.390 | 1 | 4.006 | 4.928 | 4.905 | 6.129 | 1.784 |
| | | | | | 2 | 4.346 | 5.353 | 5.244 | 6.554 | 2.085 |
| | | | | | 3 | 4.710 | 5.802 | 5.609 | 7.003 | 2.413 |
| | | | | | 4 | 5.487 | 6.784 | 6.385 | 7.985 | 3.105 |
| | | | | | 5 | 5.851 | 7.233 | 6.750 | 8.435 | 3.424 |
| | | | | | 6 | 6.117 | 7.561 | 7.016 | 8.762 | 3.659 |
| | | | | | 7 | 7.040 | 8.714 | 7.939 | 9.916 | 4.488 |
| H: 1370 | 5.692 | 6.579 | 6.590 | 7.780 | 1 | 6.264 | 7.283 | 7.477 | 8.618 | 1.784 |
| | | | | | 2 | 6.603 | 7.709 | 7.817 | 9.044 | 2.085 |
| | | | | | 3 | 6.955 | 8.157 | 8.169 | 9.492 | 2.413 |
| | | | | | 4 | 7.744 | 9.140 | 8.958 | 10.476 | 3.105 |
| | | | | | 5 | 8.096 | 9.590 | 9.310 | 10.925 | 3.424 |
| | | | | | 6 | 8.364 | 9.917 | 9.577 | 11.253 | 3.659 |
| | | | | | 7 | 9.285 | 11.070 | 10.499 | 12.406 | 4.488 |
| H: 1720 | 5.936 | 6.676 | 6.870 | 7.805 | 1 | 6.750 | 7.624 | 9.080 | 9.954 | 1.784 |
| | | | | | 2 | 7.235 | 8.266 | 9.565 | 10.596 | 2.085 |
| | | | | | 3 | 7.757 | 8.933 | 10.087 | 11.264 | 2.413 |
| | | | | | 4 | 8.873 | 10.403 | 11.203 | 12.733 | 3.105 |
| | | | | | 5 | 9.395 | 11.070 | 11.725 | 13.400 | 3.424 |
| | | | | | 6 | 9.772 | 11.580 | 12.102 | 13.910 | 3.659 |
| | | | | | 7 | 11.106 | 13.303 | 13.436 | 15.633 | 4.488 |

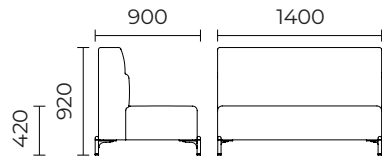

| Product | Description (Item nr) | Weight (Kg) | Dimensions (mm) | Band | Same colour (SEK) | Different seat colour (SEK) |
|------------------------------------------------------------------------------------|----------------------------------------------------------------------------|-------------|--------------------------------------------------------------------------------------|------|-------------------|-----------------------------|
|  | PEE2L FourPeople Stand Alone for back panel, 2 Seater, Low back | |  | 1 | 18.885 | 3.777 |
| | | | | 2 | 19.225 | 3.846 |
| | | | | 3 | 19.809 | 3.962 |
| | | | | 4 | 21.083 | 4.217 |
| | | | | 5 | 21.665 | 4.333 |
| | | | | 6 | 22.102 | 4.421 |
| | | | | 7 | 23.607 | 4.722 |
|  | PEE2H FourPeople Stand Alone for back panel, 2 Seater, High back | |  | 1 | 21.629 | 3.777 |
| | | | | 2 | 22.539 | 3.846 |
| | | | | 3 | 23.510 | 3.962 |
| | | | | 4 | 25.610 | 4.217 |
| | | | | 5 | 26.580 | 4.333 |
| | | | | 6 | 27.296 | 4.421 |
| | | | | 7 | 29.773 | 4.722 |

| SURCHARGE | Open panel | | Panel / Straps | | Panel / Fabric | | | Acoustic | | Armrest |
|-----------|------------|----------|----------------|----------|----------------|--------|----------|----------|----------|---------|
| | Back | 1 x Side | Back | 1 x Side | Band | Back | 1 x Side | Back | 1 x Side | 1 x |
| H: 1020 | 3.994 | 4.224 | 5.936 | 5.390 | 1 | 5.014 | 4.929 | 7.332 | 6.131 | 1.784 |
| | | | | | 2 | 5.633 | 5.354 | 7.951 | 6.555 | 2.085 |
| | | | | | 3 | 6.288 | 5.803 | 8.606 | 7.005 | 2.413 |
| | | | | | 4 | 7.696 | 6.785 | 10.014 | 7.987 | 3.105 |
| | | | | | 5 | 8.351 | 7.235 | 10.669 | 8.436 | 3.424 |
| | | | | | 6 | 8.837 | 7.562 | 11.155 | 8.764 | 3.659 |
| | | | | | 7 | 10.511 | 8.716 | 12.829 | 9.917 | 4.488 |
| H: 1370 | 6.410 | 6.580 | 8.351 | 7.781 | 1 | 7.442 | 7.283 | 9.796 | 8.618 | 1.784 |
| | | | | | 2 | 8.048 | 7.709 | 10.403 | 9.044 | 2.085 |
| | | | | | 3 | 8.703 | 8.157 | 11.058 | 9.492 | 2.413 |
| | | | | | 4 | 10.111 | 9.140 | 12.466 | 10.476 | 3.105 |
| | | | | | 5 | 10.766 | 9.590 | 13.121 | 10.925 | 3.424 |
| | | | | | 6 | 11.253 | 9.917 | 13.607 | 11.253 | 3.659 |
| | | | | | 7 | 12.927 | 11.070 | 15.281 | 12.406 | 4.488 |
| H: 1720 | 6.676 | 6.676 | 8.703 | 7.805 | 1 | 8.206 | 7.624 | 12.733 | 9.954 | 1.784 |
| | | | | | 2 | 9.116 | 8.266 | 13.643 | 10.596 | 2.085 |
| | | | | | 3 | 10.074 | 8.933 | 14.602 | 11.264 | 2.413 |
| | | | | | 4 | 12.174 | 10.403 | 16.702 | 12.733 | 3.105 |
| | | | | | 5 | 13.144 | 11.070 | 17.672 | 13.400 | 3.424 |
| | | | | | 6 | 13.861 | 11.580 | 18.388 | 13.910 | 3.659 |
| | | | | | 7 | 16.348 | 13.303 | 20.876 | 15.633 | 4.488 |

FourPeople Stand Alone for panels

[Content](#) ↗

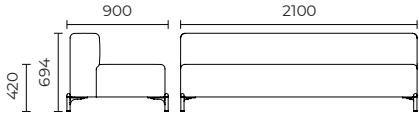
Design by Nørgaard Design

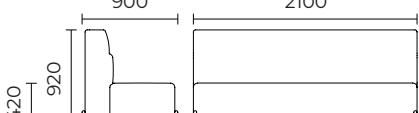
| Product | Description (Item nr) | Weight (Kg) | Dimensions (mm) | Band | Same colour (SEK) | Different seat colour (SEK) |
|-----------------------------------------------------------------------------------|----------------------------------------------------------------------------|-------------|------------------------------------------------------------------------------------|------|-------------------|-----------------------------|
|  | PEE3L FourPeople Stand Alone for back panel, 3 Seater, Low back | |  | 1 | 26.957 | 5.392 |
| | | | | 2 | 27.976 | 5.595 |
| | | | | 3 | 29.057 | 5.811 |
| | | | | 4 | 31.399 | 6.280 |
| | | | | 5 | 32.479 | 6.496 |
| | | | | 6 | 33.280 | 6.657 |
| | | | | 7 | 36.047 | 7.210 |
|  | PEE3H FourPeople Stand Alone for back panel, 3 Seater, High back | |  | 1 | 31.242 | 5.392 |
| | | | | 2 | 32.491 | 5.595 |
| | | | | 3 | 33.827 | 5.811 |
| | | | | 4 | 36.703 | 6.280 |
| | | | | 5 | 38.025 | 6.496 |
| | | | | 6 | 39.009 | 6.657 |
| | | | | 7 | 42.420 | 7.210 |

| SURCHARGE | Open panel | | Panel / Straps | | Panel / Fabric | | | Acoustic | | Armrest |
|-----------|--------------|-------|----------------|-------|----------------|--------|--------|----------|--------|----------|
| | Panel height | Back | 1 x Side | Back | 1 x Side | Band | Back | 1 x Side | Back | 1 x Side |
| H: 1020 | 4.322 | 4.225 | 8.121 | 5.390 | 1 | 6.725 | 4.929 | 9.310 | 6.131 | 1.784 |
| | | | | | 2 | 7.635 | 5.354 | 10.220 | 6.555 | 2.085 |
| | | | | | 3 | 8.594 | 5.803 | 11.179 | 7.005 | 2.413 |
| | | | | | 4 | 10.694 | 6.785 | 13.279 | 7.987 | 3.105 |
| | | | | | 5 | 11.665 | 7.235 | 14.250 | 8.436 | 3.424 |
| | | | | | 6 | 12.381 | 7.562 | 14.966 | 8.764 | 3.659 |
| | | | | | 7 | 14.869 | 8.716 | 17.454 | 9.917 | 4.488 |
| H: 1370 | 7.539 | 6.580 | 10.524 | 7.781 | 1 | 9.055 | 7.283 | 13.618 | 8.618 | 1.784 |
| | | | | | 2 | 9.966 | 7.709 | 14.529 | 9.044 | 2.085 |
| | | | | | 3 | 10.924 | 8.157 | 15.487 | 9.492 | 2.413 |
| | | | | | 4 | 13.024 | 9.140 | 17.587 | 10.476 | 3.105 |
| | | | | | 5 | 13.995 | 9.590 | 18.558 | 10.925 | 3.424 |
| | | | | | 6 | 14.711 | 9.917 | 19.274 | 11.253 | 3.659 |
| | | | | | 7 | 17.199 | 11.070 | 21.762 | 12.406 | 4.488 |
| H: 1720 | 4.147 | 6.676 | 10.646 | 7.805 | 1 | 9.796 | 7.624 | 14.409 | 9.954 | 1.784 |
| | | | | | 2 | 11.155 | 8.266 | 15.768 | 10.596 | 2.085 |
| | | | | | 3 | 12.587 | 8.933 | 17.199 | 11.264 | 2.413 |
| | | | | | 4 | 15.706 | 10.403 | 20.318 | 12.733 | 3.105 |
| | | | | | 5 | 17.151 | 11.070 | 21.764 | 13.400 | 3.424 |
| | | | | | 6 | 18.218 | 11.580 | 22.831 | 13.910 | 3.659 |
| | | | | | 7 | 21.921 | 13.303 | 26.533 | 15.633 | 4.488 |

| ACCESSORIES | Description | Weight (Kg) | Dimensions (mm) | Band | Price (SEK) |
|-------------------------------------------------------------------------------------|--------------------------------|-------------|-----------------|------|-------------|
|  | FOURPEOPLE TRAY ACC1002 | 1,8 kg | | | 478 |
|  | FOURPEOPLE HOOK ACC1001 | 0,1 kg | | | 126 |

FourPeople Modules

Design by Nørgaard Design

[Content ↗](#)



Configuration Example 1

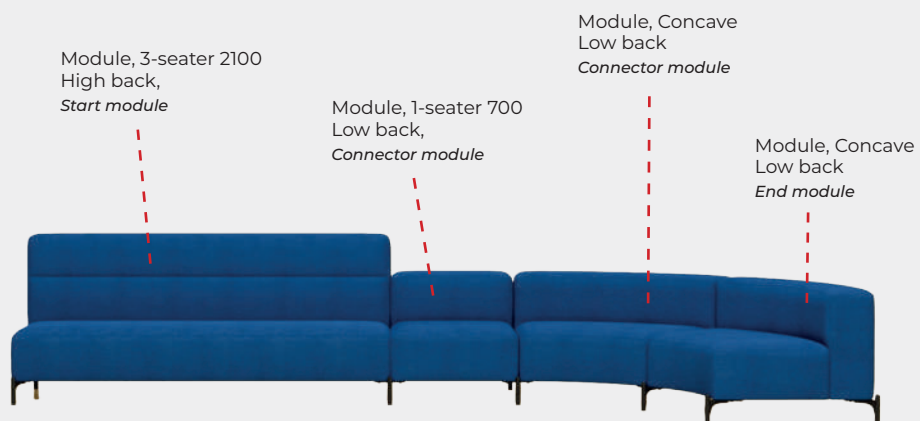

Modules overview

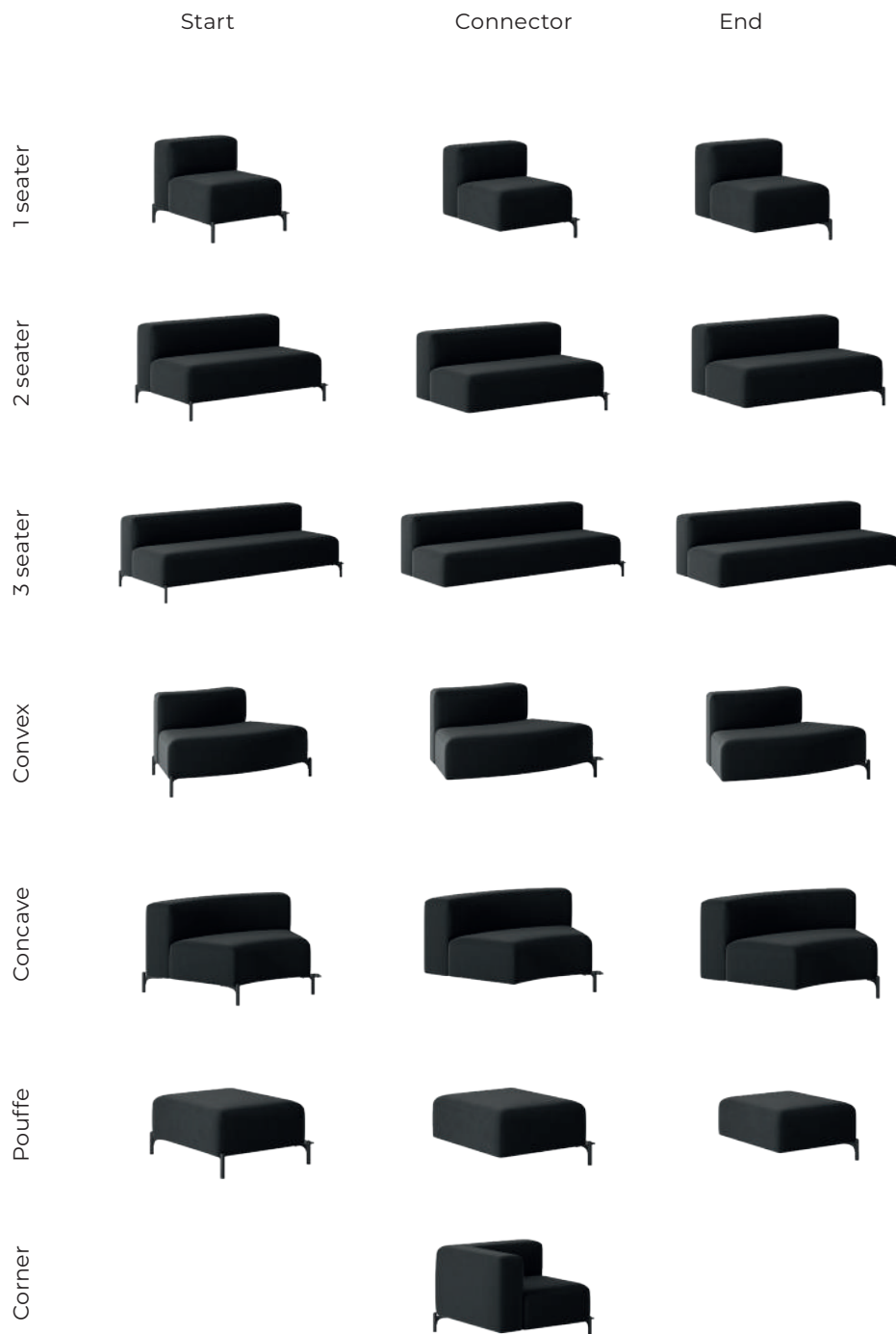

FourPeople Modules

Design by Nørgaard Design

[Content ↗](#)



FEATURES







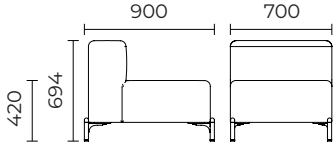

- Multifunctional modular soft seating range.
- The range includes one, two & three seater modules; convex, concave & corner modules; and pouffe.
- The price is the same if it's a start, connector or an end module.
- Two tone fabric options available & armrest option.
- Electrical units are optional and will be positioned on the left or right side of sofas as standard.
- Leg and frame in black (RAL7021).
- Upholstery available in various fabrics. For recommendations, please contact your sales representative.

For product information visit oceefour.com ↗

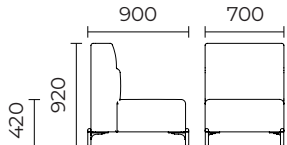
For electrical accessories [go to page 228](#) ↗

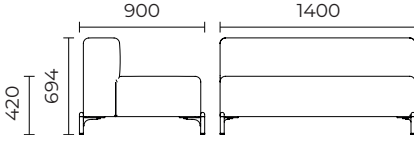

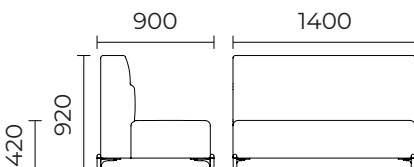







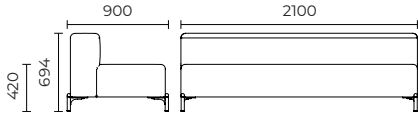

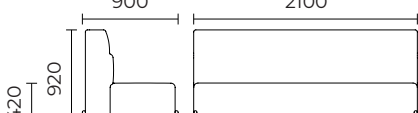

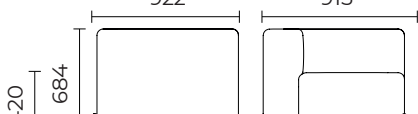

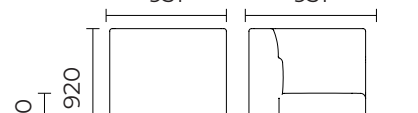
For full band and colour details [go to page 238](#) ↗

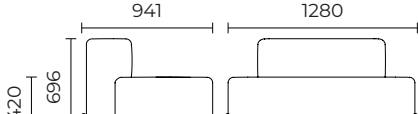
| Product | Description (Item nr) | Weight (Kg) | Dimensions (mm) | Band | Same colour (SEK) | Different seat colour (SEK) |
|-------------------------------------------------------------------------------------|---------------------------------------------------------|-------------|--------------------------------------------------------------------------------------|---------------------------------|--------------------------------------------------------------------|-------------------------------------------------------------|
|  | PEC1 FourPeople Modules - Low back, 1 Seater | |  | 1 2 3 4 5 6 7 | 12.040 12.490 12.962 13.983 14.455 14.807 16.021 | 2.409 2.498 2.592 2.796 2.891 2.962 3.205 |
|  | PED1 FourPeople Modules - High back, 1 Seater | |  | 1 2 3 4 5 6 7 | 13.861 14.407 14.990 16.264 16.847 17.284 18.788 | 2.409 2.498 2.592 2.796 2.891 2.962 3.474 |
|  | PEC2 FourPeople Modules - Low back, 2 Seater | |  | 1 2 3 4 5 6 7 | 18.885 19.225 19.809 21.083 21.665 22.102 23.607 | 3.777 3.846 3.962 4.217 4.333 4.421 4.722 |
|  | PED2 FourPeople Modules - High back, 2 Seater | |  | 1 2 3 4 5 6 7 | 21.629 22.539 23.510 25.610 26.580 27.296 29.773 | 3.777 3.846 3.962 4.217 4.333 4.421 4.722 |

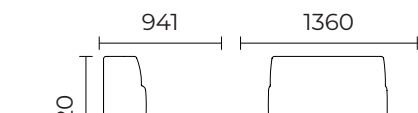
FourPeople Modules

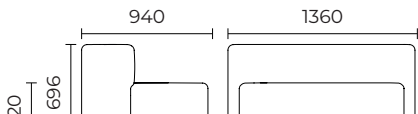
Design by Nørgaard Design

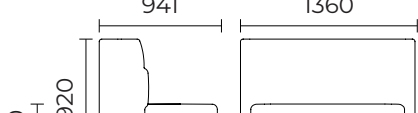
[Content](#) ↗

| Product | Description (Item nr) | Weight (Kg) | Dimensions (mm) | Band | Same colour (SEK) | Different seat colour (SEK) |
|-------------------------------------------------------------------------------------|-----------------------------------------------------------|-------------|--------------------------------------------------------------------------------------|---------------------------------|--------------------------------------------------------------------|-------------------------------------------------------------|
|  | PEC3 FourPeople Modules - Low back, 3 Seater | |  | 1 2 3 4 5 6 7 | 26.957 27.976 29.057 31.399 32.479 33.280 36.047 | 5.392 5.595 5.811 6.280 6.496 6.657 7.210 |
|  | PED3 FourPeople Modules - High back, 3 Seater | |  | 1 2 3 4 5 6 7 | 31.242 32.491 33.827 36.703 38.025 39.009 42.420 | 5.392 5.595 5.811 6.280 6.496 6.657 7.210 |
|  | PECC FourPeople Modules - Low back, Corner 90° | |  | 1 2 3 4 5 6 7 | 18.303 19.032 19.796 21.447 22.211 22.783 24.748 | 3.661 3.807 3.959 4.290 4.443 4.557 4.950 |
|  | PEDC FourPeople Modules - High back, Corner 90° | |  | 1 2 3 4 5 6 7 | 22.394 23.365 24.396 26.642 27.673 28.450 31.109 | 3.661 3.807 3.959 4.290 4.443 4.557 4.950 |
|  | PECV FourPeople Modules - Low back, Convex | |  | 1 2 3 4 5 6 7 | 18.485 19.080 19.711 21.070 21.702 22.176 23.790 | 3.698 3.817 3.943 4.214 4.340 4.436 4.758 |
|  | PEDV FourPeople Modules - High back, Convex | |  | 1 2 3 4 5 6 7 | 21.035 21.884 22.783 24.736 25.635 26.302 28.614 | 3.698 3.817 3.943 4.214 4.340 4.436 4.758 |
|  | PECA FourPeople Modules - Low back, Concave | |  | 1 2 3 4 5 6 7 | 19.190 19.888 20.633 22.242 22.983 23.535 25.440 | 3.839 3.979 4.127 4.448 4.596 4.707 5.088 |
|  | PEDA FourPeople Modules - High back, Concave | |  | 1 2 3 4 5 6 7 | 22.795 23.668 24.591 26.587 27.510 28.195 30.562 | 3.839 3.979 4.127 4.448 4.596 4.707 5.088 |
|  | PECP FourPeople Modules - Low back, Pouf | |  | 1 2 3 4 5 6 7 | 9.795 10.147 10.535 11.361 11.748 12.028 13.011 | |

FourPeople Modules

Design by Nørgaard Design

[Content ↗](#)

| ACCESSORIES | Description | Weight (Kg) | Dimensions (mm) | Band | Price (SEK) |
|-----------------------------------------------------------------------------------|------------------------------------|-------------|--------------------|------|-------------|
|  | armrest | | 800 x 486 x 134 mm | 1 | 1.784 |
| | | | | 2 | 2.085 |
| | | | | 3 | 2.413 |
| | | | | 4 | 3.105 |
| | | | | 5 | 3.424 |
| | | | | 6 | 3.659 |
| | | | | 7 | 4.488 |
|  | FOURPEOPLE TRAY ACC1002 | 1,8 kg | | | 478 |



FourPeople Modules for Panels

Design by Nørgaard Design

[Content ↗](#)

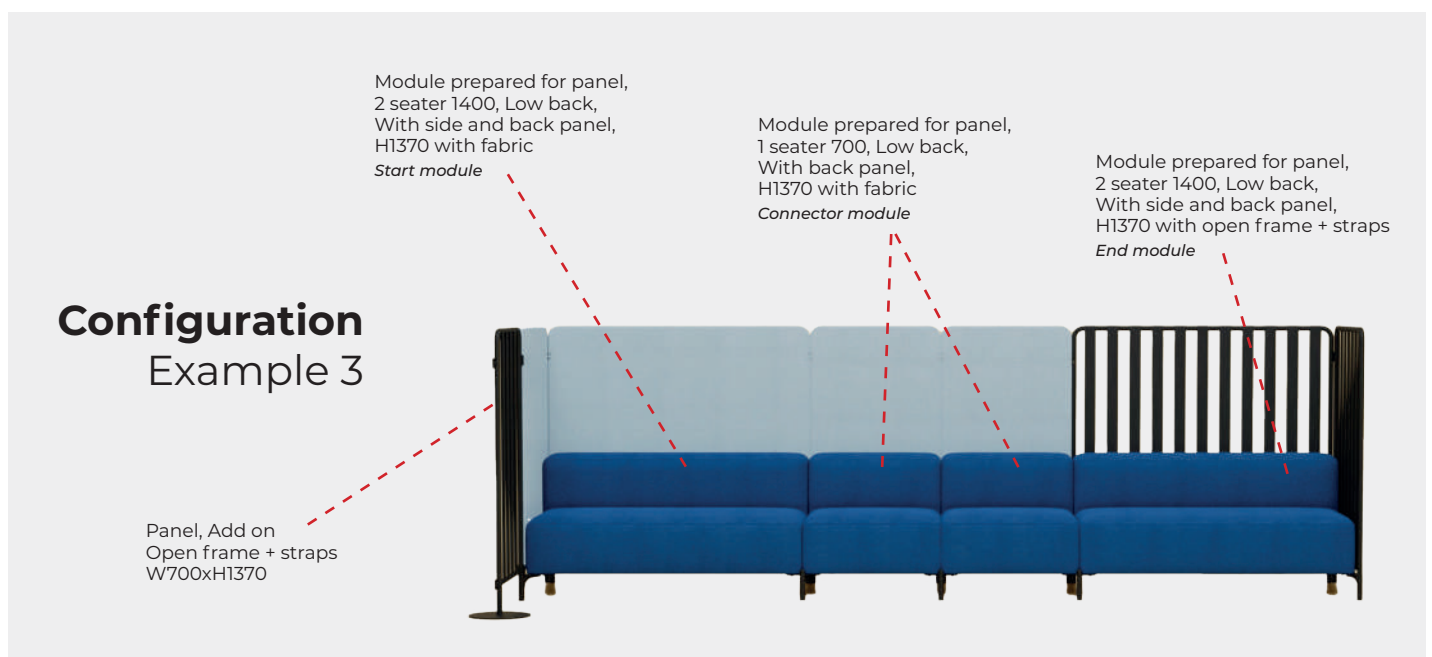

FourPeople Modules for Panels

Design by Nørgaard Design

[Content ↗](#)

Modules overview

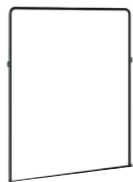
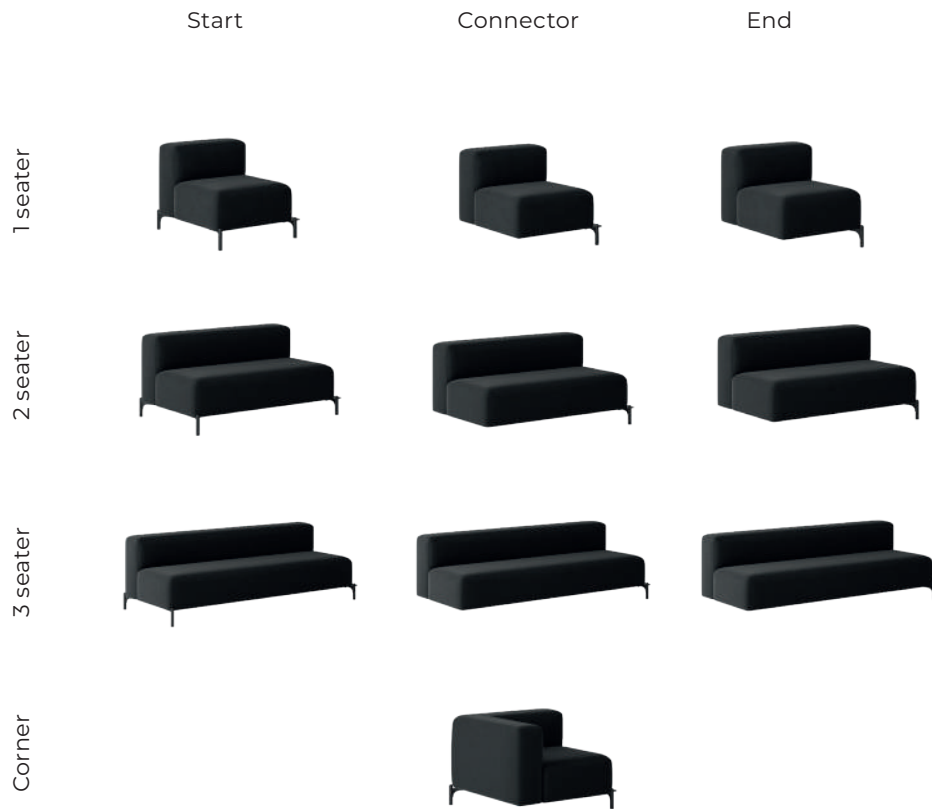

Open Panel

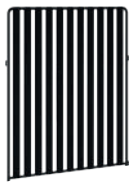

Panel with straps

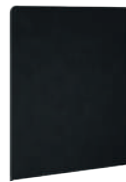

Panel with fabric



Panel Fabric with Acoustic

FourPeople Modules for panels

Design by Nørgaard Design

[Content ↗](#)



FEATURES



- Multifunctional modular soft seating range with panels. As a standard, modules with or without panels cannot be connected.
- All modules can have panels on the back and side at the same time. Modules cannot have just a side panel. (two sides available for start module).
- The price is the same if it's a start, connector or an end module.
- Panel Options: Open panel, Panel with straps, Fabric Panel, Fabric Panel with Acoustic Filling.
- Armrest option (cannot combine armrest and side panels on the same side).
- Two tone fabric options available.
- Electrical units are optional and will be positioned on the left or right side of sofas as standard.
- Leg and frame in black (RAL7021).
- Upholstery available in various fabrics. For recommendations, please contact your sales representative.

For product information visit oceefour.com ↗

For electrical accessories [go to page 228](#) ↗

For full band and colour details [go to page 238](#) ↗



| Product | Description (Item nr) | Weight (Kg) | Dimensions (mm) | Band | Same colour (SEK) | Different seat colour (SEK) |
|---------|----------------------------------------------------------------------|-------------|-----------------|---------------------------------|--------------------------------------------------------------------|-------------------------------------------------------------|
| | PEA1 FourPeople Modules low back for back panel, 1 Seater | | | 1 2 3 4 5 6 7 | 12.040 12.490 12.962 13.983 14.455 14.807 16.021 | 2.409 2.498 2.592 2.796 2.891 2.962 3.205 |
| | PEB1 FourPeople Modules high back for back panel, 1 Seater | | | 1 2 3 4 5 6 7 | 13.861 14.407 14.990 16.264 16.847 17.284 18.788 | 2.409 2.498 2.592 2.796 2.891 2.962 3.474 |

FourPeople Modules for panels

[Content](#) ↗

Design by Nørgaard Design

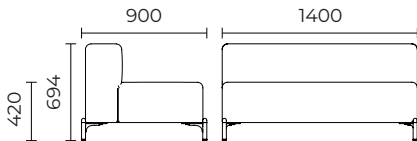
| SURCHARGE | Open panel | | Panel / Straps | | Panel / Fabric | | | Acoustic | | Armrest |
|-----------|--------------|-------|----------------|-------|----------------|--------|--------|----------|--------|----------|
| | Panel height | Back | 1 x Side | Back | 1 x Side | Band | Back | 1 x Side | Back | 1 x Side |
| H: 1020 | 3.447 | 4.224 | 4.321 | 5.390 | 1 | 4.006 | 4.929 | 4.905 | 6.131 | 1.784 |
| | | | | | 2 | 4.346 | 5.354 | 5.244 | 6.555 | 2.085 |
| | | | | | 3 | 4.710 | 5.803 | 5.609 | 7.005 | 2.413 |
| | | | | | 4 | 5.487 | 6.785 | 6.385 | 7.987 | 3.105 |
| | | | | | 5 | 5.851 | 7.235 | 6.750 | 8.436 | 3.424 |
| | | | | | 6 | 6.117 | 7.562 | 7.016 | 8.764 | 3.659 |
| | | | | | 7 | 7.040 | 8.716 | 7.939 | 9.917 | 4.488 |
| H: 1370 | 5.694 | 6.580 | 6.591 | 7.781 | 1 | 6.264 | 7.283 | 7.477 | 8.618 | 1.784 |
| | | | | | 2 | 6.603 | 7.709 | 7.817 | 9.044 | 2.085 |
| | | | | | 3 | 6.955 | 8.157 | 8.169 | 9.492 | 2.413 |
| | | | | | 4 | 7.744 | 9.140 | 8.958 | 10.476 | 3.105 |
| | | | | | 5 | 8.096 | 9.590 | 9.310 | 10.925 | 3.424 |
| | | | | | 6 | 8.364 | 9.917 | 9.577 | 11.253 | 3.659 |
| | | | | | 7 | 9.285 | 11.070 | 10.499 | 12.406 | 4.488 |
| H: 1720 | 5.936 | 6.676 | 6.870 | 7.805 | 1 | 6.750 | 7.624 | 9.080 | 9.954 | 1.784 |
| | | | | | 2 | 7.235 | 8.266 | 9.565 | 10.596 | 2.085 |
| | | | | | 3 | 7.757 | 8.933 | 10.087 | 11.264 | 2.413 |
| | | | | | 4 | 8.873 | 10.403 | 11.203 | 12.733 | 3.105 |
| | | | | | 5 | 9.395 | 11.070 | 11.725 | 13.400 | 3.424 |
| | | | | | 6 | 9.772 | 11.580 | 12.102 | 13.910 | 3.659 |
| | | | | | 7 | 11.106 | 13.303 | 13.436 | 15.633 | 4.488 |

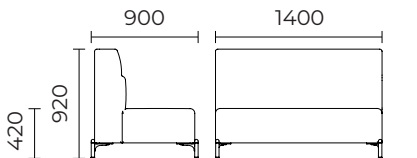

| Product | Description (Item nr) | Weight (Kg) | Dimensions (mm) | Band | Same colour (SEK) | Different seat colour (SEK) |
|-------------------------------------------------------------------------------------|----------------------------------------------------------------------|-------------|--------------------------------------------------------------------------------------|------|-------------------|-----------------------------|
|  | PEA2 FourPeople Modules low back for back panel, 2 Seater | |  | 1 | 18.885 | 3.777 |
| | | | | 2 | 19.225 | 3.846 |
| | | | | 3 | 19.809 | 3.962 |
| | | | | 4 | 21.083 | 4.217 |
| | | | | 5 | 21.665 | 4.333 |
| | | | | 6 | 22.102 | 4.421 |
| | | | | 7 | 23.607 | 4.722 |
|  | PEB2 FourPeople Modules high back for back panel, 2 Seater | |  | 1 | 21.629 | 3.777 |
| | | | | 2 | 22.539 | 3.846 |
| | | | | 3 | 23.510 | 3.962 |
| | | | | 4 | 25.610 | 4.217 |
| | | | | 5 | 26.580 | 4.333 |
| | | | | 6 | 27.296 | 4.421 |
| | | | | 7 | 29.773 | 4.722 |

| SURCHARGE | Open panel | | Panel / Straps | | Panel / Fabric | | | Acoustic | | Armrest |
|-----------|--------------|-------|----------------|-------|----------------|--------|--------|----------|--------|----------|
| | Panel height | Back | 1 x Side | Back | 1 x Side | Band | Back | 1 x Side | Back | 1 x Side |
| H: 1020 | 3.994 | 4.224 | 5.936 | 5.390 | 1 | 5.014 | 4.929 | 7.332 | 6.131 | 1.784 |
| | | | | | 2 | 5.633 | 5.354 | 7.951 | 6.555 | 2.085 |
| | | | | | 3 | 6.288 | 5.803 | 8.606 | 7.005 | 2.413 |
| | | | | | 4 | 7.696 | 6.785 | 10.014 | 7.987 | 3.105 |
| | | | | | 5 | 8.351 | 7.235 | 10.669 | 8.436 | 3.424 |
| | | | | | 6 | 8.837 | 7.562 | 11.155 | 8.764 | 3.659 |
| | | | | | 7 | 10.511 | 8.716 | 12.829 | 9.917 | 4.488 |
| H: 1370 | 6.410 | 6.580 | 8.351 | 7.781 | 1 | 7.442 | 7.283 | 9.796 | 8.618 | 1.784 |
| | | | | | 2 | 8.048 | 7.709 | 10.403 | 9.044 | 2.085 |
| | | | | | 3 | 8.703 | 8.157 | 11.058 | 9.492 | 2.413 |
| | | | | | 4 | 10.111 | 9.140 | 12.466 | 10.476 | 3.105 |
| | | | | | 5 | 10.766 | 9.590 | 13.121 | 10.925 | 3.424 |
| | | | | | 6 | 11.253 | 9.917 | 13.607 | 11.253 | 3.659 |
| | | | | | 7 | 12.927 | 11.070 | 15.281 | 12.406 | 4.488 |
| H: 1720 | 6.676 | 6.676 | 8.703 | 7.805 | 1 | 8.206 | 7.624 | 12.733 | 9.954 | 1.784 |
| | | | | | 2 | 9.116 | 8.266 | 13.643 | 10.596 | 2.085 |
| | | | | | 3 | 10.074 | 8.933 | 14.602 | 11.264 | 2.413 |
| | | | | | 4 | 12.174 | 10.403 | 16.702 | 12.733 | 3.105 |
| | | | | | 5 | 13.144 | 11.070 | 17.672 | 13.400 | 3.424 |
| | | | | | 6 | 13.861 | 11.580 | 18.388 | 13.910 | 3.659 |
| | | | | | 7 | 16.348 | 13.303 | 20.876 | 15.633 | 4.488 |

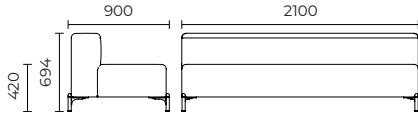

FourPeople Modules for panels

[Content ↗](#)

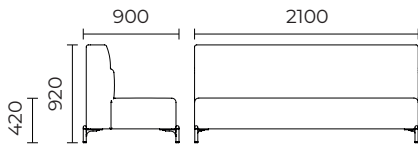
Design by Nørgaard Design

| Product | Description (Item nr) | Weight (Kg) | Dimensions (mm) | Band | Same colour (SEK) | Different seat colour (SEK) |
|----------------------------------------------------------------------------------|----------------------------------------------------------------------|-------------|------------------------------------------------------------------------------------|------|-------------------|-----------------------------|
|  | PEA3 FourPeople Modules low back for back panel, 3 Seater | |  | 1 | 26.957 | 5.392 |
| | | | | 2 | 27.976 | 5.595 |
| | | | | 3 | 29.057 | 5.811 |
| | | | | 4 | 31.399 | 6.280 |
| | | | | 5 | 32.479 | 6.496 |
| | | | | 6 | 33.280 | 6.657 |
| | | | | 7 | 36.047 | 7.210 |
|  | PEB3 FourPeople Modules high back for back panel, 3 Seater | |  | 1 | 31.242 | 5.392 |
| | | | | 2 | 32.491 | 5.595 |
| | | | | 3 | 33.827 | 5.811 |
| | | | | 4 | 36.703 | 6.280 |
| | | | | 5 | 38.025 | 6.496 |
| | | | | 6 | 39.009 | 6.657 |
| | | | | 7 | 42.420 | 7.210 |

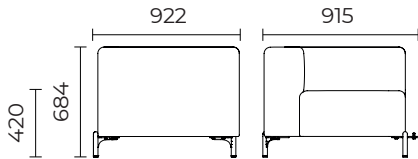
| SURCHARGE | Open panel | | Panel / Straps | | Panel / Fabric | | | Acoustic | | Armrest | |
|--------------|------------|----------|----------------|----------|----------------|--------|----------|----------|----------|---------|-------|
| | Back | 1 x Side | Back | 1 x Side | Band | Back | 1 x Side | Back | 1 x Side | 1 x | |
| Panel height | H: 1020 | 4.322 | 4.225 | 8.121 | 5.390 | 1 | 6.725 | 4.929 | 9.310 | 6.131 | 1.784 |
| | | | | | | 2 | 7.635 | 5.354 | 10.220 | 6.555 | 2.085 |
| | | | | | | 3 | 8.594 | 5.803 | 11.179 | 7.005 | 2.413 |
| | | | | | | 4 | 10.694 | 6.785 | 13.279 | 7.987 | 3.105 |
| | | | | | | 5 | 11.665 | 7.235 | 14.250 | 8.436 | 3.424 |
| | | | | | | 6 | 12.381 | 7.562 | 14.966 | 8.764 | 3.659 |
| | | | | | | 7 | 14.869 | 8.716 | 17.454 | 9.917 | 4.488 |
| H: 1370 | 7.539 | 6.580 | 10.524 | 7.781 | 1 | 9.055 | 7.283 | 13.618 | 8.618 | 1.784 | |
| | | | | | 2 | 9.966 | 7.709 | 14.529 | 9.044 | 2.085 | |
| | | | | | 3 | 10.924 | 8.157 | 15.487 | 9.492 | 2.413 | |
| | | | | | 4 | 13.024 | 9.140 | 17.587 | 10.476 | 3.105 | |
| | | | | | 5 | 13.995 | 9.590 | 18.558 | 10.925 | 3.424 | |
| | | | | | 6 | 14.711 | 9.917 | 19.274 | 11.253 | 3.659 | |
| | | | | | 7 | 17.199 | 11.070 | 21.762 | 12.406 | 4.488 | |
| H: 1720 | 4.147 | 6.676 | 10.646 | 7.805 | 1 | 9.796 | 7.624 | 14.409 | 9.954 | 1.784 | |
| | | | | | 2 | 11.155 | 8.266 | 15.768 | 10.596 | 2.085 | |
| | | | | | 3 | 12.587 | 8.933 | 17.199 | 11.264 | 2.413 | |
| | | | | | 4 | 15.706 | 10.403 | 20.318 | 12.733 | 3.105 | |
| | | | | | 5 | 17.151 | 11.070 | 21.764 | 13.400 | 3.424 | |
| | | | | | 6 | 18.218 | 11.580 | 22.831 | 13.910 | 3.659 | |
| | | | | | 7 | 21.921 | 13.303 | 26.533 | 15.633 | 4.488 | |

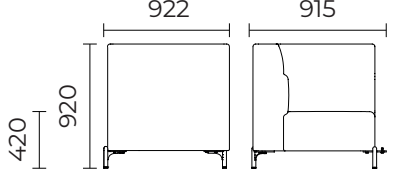
| Product | Description (Item nr) | Weight (Kg) | Dimensions (mm) | Band | Same colour (SEK) | Different seat colour (SEK) |
|------------------------------------------------------------------------------------|------------------------------------------------------------------------|-------------|--------------------------------------------------------------------------------------|------|-------------------|-----------------------------|
|  | PEAC FourPeople Modules low back for back panel, Corner 90° | |  | 1 | 18.303 | 3.661 |
| | | | | 2 | 19.032 | 3.807 |
| | | | | 3 | 19.796 | 3.959 |
| | | | | 4 | 21.447 | 4.290 |
| | | | | 5 | 22.211 | 4.443 |
| | | | | 6 | 22.783 | 4.557 |
| | | | | 7 | 24.748 | 4.950 |
|  | PEBC FourPeople Modules high back for back panel, Corner 90° | |  | 1 | 22.394 | 3.661 |
| | | | | 2 | 23.365 | 3.807 |
| | | | | 3 | 24.396 | 3.959 |
| | | | | 4 | 26.642 | 4.290 |
| | | | | 5 | 27.673 | 4.443 |
| | | | | 6 | 28.450 | 4.557 |
| | | | | 7 | 31.109 | 4.950 |

FourPeople Modules for panels

[Content](#) ↗

Design by Nørgaard Design

| SURCHARGE | Open panel | | Panel / Straps | | Panel / Fabric | | | Acoustic | | Armrest |
|-----------|--------------|-------|----------------|-------|----------------|--------|--------|----------|--------|----------|
| | Panel height | Back | 1 x Side | Back | 1 x Side | Band | Back | 1 x Side | Back | 1 x Side |
| H: 1020 | 4.224 | 4.224 | 5.390 | 5.390 | 1 | 4.929 | 4.929 | 6.131 | 6.131 | 1.784 |
| | | | | | 2 | 5.354 | 5.354 | 6.555 | 6.555 | 2.085 |
| | | | | | 3 | 5.803 | 5.803 | 7.005 | 7.005 | 2.413 |
| | | | | | 4 | 6.785 | 6.785 | 7.987 | 7.987 | 3.105 |
| | | | | | 5 | 7.235 | 7.235 | 8.436 | 8.436 | 3.424 |
| | | | | | 6 | 7.562 | 7.562 | 8.764 | 8.764 | 3.659 |
| | | | | | 7 | 8.716 | 8.716 | 9.917 | 9.917 | 4.488 |
| H: 1370 | 6.580 | 6.580 | 7.781 | 7.781 | 1 | 7.283 | 7.283 | 8.618 | 8.618 | 1.784 |
| | | | | | 2 | 7.709 | 7.709 | 9.044 | 9.044 | 2.085 |
| | | | | | 3 | 8.157 | 8.157 | 9.492 | 9.492 | 2.413 |
| | | | | | 4 | 9.140 | 9.140 | 10.476 | 10.476 | 3.105 |
| | | | | | 5 | 9.590 | 9.590 | 10.925 | 10.925 | 3.424 |
| | | | | | 6 | 9.917 | 9.917 | 11.253 | 11.253 | 3.659 |
| | | | | | 7 | 11.070 | 11.070 | 12.406 | 12.406 | 4.488 |
| H: 1720 | 6.676 | 6.676 | 7.805 | 7.805 | 1 | 7.624 | 7.624 | 9.954 | 9.954 | 1.784 |
| | | | | | 2 | 8.266 | 8.266 | 10.596 | 10.596 | 2.085 |
| | | | | | 3 | 8.933 | 8.933 | 11.264 | 11.264 | 2.413 |
| | | | | | 4 | 10.403 | 10.403 | 12.733 | 12.733 | 3.105 |
| | | | | | 5 | 11.070 | 11.070 | 13.400 | 13.400 | 3.424 |
| | | | | | 6 | 11.580 | 11.580 | 13.910 | 13.910 | 3.659 |
| | | | | | 7 | 13.303 | 13.303 | 15.633 | 15.633 | 4.488 |

| ACCESSORIES | Description | Weight (Kg) | Dimensions (mm) | Band | Price (SEK) |
|-------------------------------------------------------------------------------------|------------------------------------|-------------|-----------------|------|-------------|
|  | FOURPEOPLE TRAY ACC1002 | 1,8 kg | | | 478 |
|  | FOURPEOPLE HOOK ACC1001 | 0,1 kg | | | 126 |

FourPeople Stand alone panels

Design by Nørgaard Design

[Content](#) ↗









FEATURES

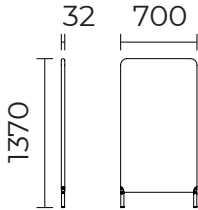

- Panel Options: Open panel, Panel with straps, Fabric Panel, Fabric Panel with Acoustic Filling
- Offer acoustic and visual privacy
- Leg and frame in black (RAL7021)
- Diameter of foot 30 cm
- Upholstery available in various fabrics. For recommendations, please contact your sales representative

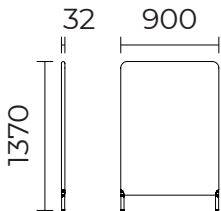

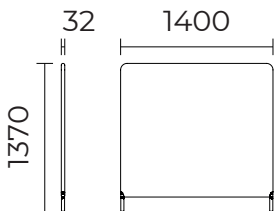

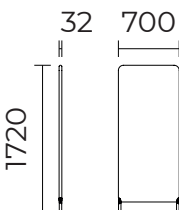





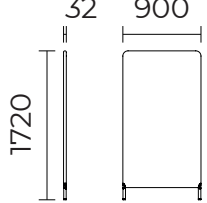

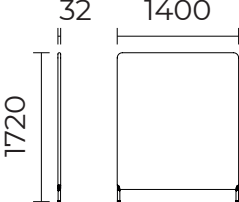

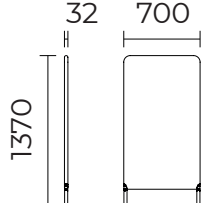
For product information visit oceefour.com ↗

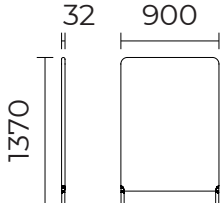
For full band and colour details [go to page 238](#) ↗

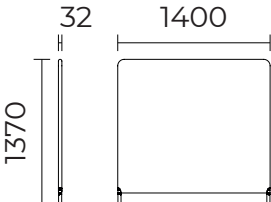
| Product | Description (Item nr) | Weight (Kg) | Dimensions (mm) | Band | Standard (SEK) |
|-------------------------------------------------------------------------------------|--------------------------------------------------------------------------|-------------|-------------------------------------------------------------------------------------|------|----------------|
|  | PEG1131 FourPeople Panel, Stand alone, W: 700, H: 1370, Frame | - |  | - | 9.250 |
|  | PEG1231 FourPeople Panel, Stand alone, W: 900, H: 1370, Frame | - |  | - | 9.455 |
|  | PEG1331 FourPeople Panel, Stand alone, W: 1400, H: 1370, Frame | - |  | - | 9.966 |
|  | PEG1141 FourPeople Panel, Stand alone, W: 700, H: 1720, Frame | - |  | - | 9.492 |

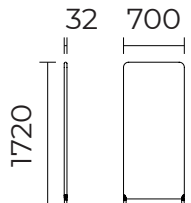
FourPeople Stand alone panels

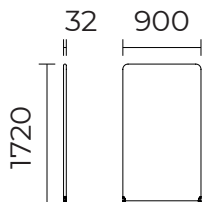

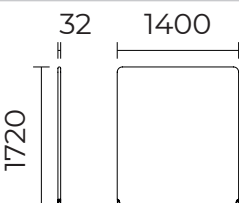
Design by Nørgaard Design

| Product | Description (Item nr) | Weight (Kg) | Dimensions (mm) | Band | Standard (SEK) |
|-------------------------------------------------------------------------------------|---------------------------------------------------------------------------|-------------|-------------------------------------------------------------------------------------|------|-------------------|
|  | PEG1241 FourPeople Panel, Stand alone, W: 900, H: 1720, Frame | - |  | - | 9.553 |
|  | PEG1341 FourPeople Panel, Stand alone, W: 1400, H: 1720, Frame | - |  | - | 10.232 |
|  | PEG1132 FourPeople Panel, Stand alone, W: 700, H: 1370, Straps | - |  | - | 10.147 |
|  | PEG1232 FourPeople Panel, Stand alone, W: 900, H: 1370, Straps | - |  | - | 10.646 |
|  | PEG1332 FourPeople Panel, Stand alone, W: 1400, H: 1370, Straps | - |  | - | 11.907 |
|  | PEG1142 FourPeople Panel, Stand alone, W: 700, H: 1720, Straps | - |  | - | 10.414 |
|  | PEG1242 FourPeople Panel, Stand alone, W: 900, H: 1720, Straps | - |  | - | 10.791 |
|  | PEG1342 FourPeople Panel, Stand alone, W: 1400, H: 1720, Straps | - |  | - | 12.259 |

FourPeople Stand alone panels

[Content ↗](#)

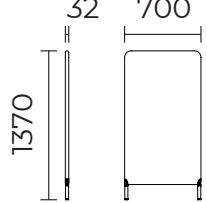

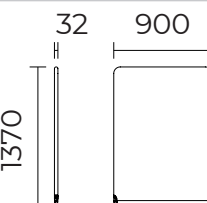



Design by Nørgaard Design

| Product | Description (Item nr) | Weight (Kg) | Dimensions (mm) | Band | Standard (SEK) |
|-------------------------------------------------------------------------------------|----------------------------------------------------------------------------------------|-------------|-------------------------------------------------------------------------------------|---------------------------------|--------------------------------------------------------------------|
|  | PEG1133 FourPeople Panel, Stand alone, W: 700, H: 1370, Fabric | - |  | 1 2 3 4 5 6 7 | 9.772 10.099 10.427 11.168 11.507 11.750 12.624 |
|  | PEG1233 FourPeople Panel, Stand alone, W: 900, H: 1370, Fabric | - |  | 1 2 3 4 5 6 7 | 10.124 10.524 10.948 11.883 12.309 12.624 13.716 |
|  | PEG1333 FourPeople Panel, Stand alone, W: 1400, H: 1370, Fabric | - |  | 1 2 3 4 5 6 7 | 10.985 11.605 12.259 13.668 14.322 14.809 16.483 |
|  | PEG1143 FourPeople Panel, Stand alone, W: 700, H: 1720, Fabric | - |  | 1 2 3 4 5 6 7 | 10.269 10.731 11.228 12.296 12.794 13.158 14.432 |
|  | PEG1243 FourPeople Panel, Stand alone, W: 900, H: 1720, Fabric | - |  | 1 2 3 4 5 6 7 | 10.536 11.131 11.762 13.133 13.765 14.225 15.840 |
|  | PEG1343 FourPeople Panel, Stand alone, W: 1400, H: 1720, Fabric | - |  | 1 2 3 4 5 6 7 | 11.750 12.659 13.631 15.731 16.702 17.418 19.894 |
|  | PEG1134 FourPeople Panel, Stand alone, W: 700, H: 1370, Fabric with acoustic | - |  | 1 2 3 4 5 6 7 | 10.985 11.313 11.640 12.381 12.721 12.964 13.837 |
|  | PEG1234 FourPeople Panel, Stand alone, W: 900, H: 1370, Fabric with acoustic | - |  | 1 2 3 4 5 6 7 | 11.459 11.859 12.284 13.218 13.644 13.959 15.051 |

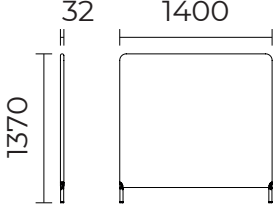
FourPeople Stand alone panels

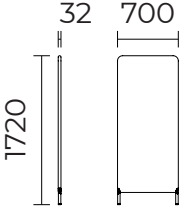
[Content ↗](#)

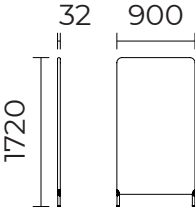
Design by Nørgaard Design

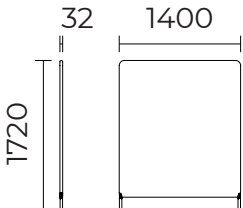
| Product | Description (Item nr) | Weight (Kg) | Dimensions (mm) | Band | Standard (SEK) |
|-------------------------------------------------------------------------------------|-----------------------------------------------------------------------------------------|-------------|------------------------------------------------------------------------------------|---------------------------------|--------------------------------------------------------------------|
|  | PEG1334 FourPeople Panel, Stand alone, W: 1400, H: 1370, Fabric with acoustic | - |  | 1 2 3 4 5 6 7 | 13.340 13.959 14.614 16.022 16.677 17.164 18.837 |
|  | PEG1144 FourPeople Panel, Stand alone, W: 700, H: 1720, Fabric with acoustic | - |  | 1 2 3 4 5 6 7 | 13.474 13.936 14.433 15.502 15.999 16.364 17.637 |
|  | PEG1244 FourPeople Panel, Stand alone, W: 900, H: 1720, Fabric with acoustic | - |  | 1 2 3 4 5 6 7 | 12.866 13.461 14.092 15.464 16.095 16.555 18.170 |
|  | PEG1344 FourPeople Panel, Stand alone, W: 1400, H: 1720, Fabric with acoustic | - |  | 1 2 3 4 5 6 7 | 16.277 17.187 18.158 20.258 21.229 21.946 24.421 |

| ACCESSORIES | Description | Weight (Kg) | Dimensions (mm) | Band | Price (SEK) |
|-------------------------------------------------------------------------------------|------------------------------------|-------------|-----------------|------|-------------|
|  | FOURPEOPLE HOOK ACC1001 | 0,1 kg | | | 126 |

FourPeople Add on panels

Design by Nørgaard Design

[Content ↗](#)

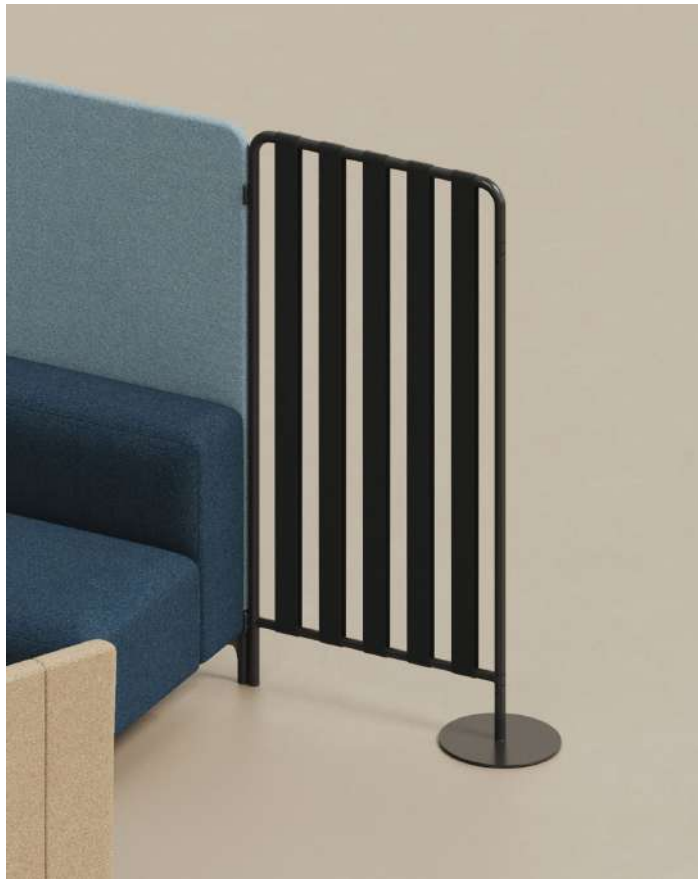

FEATURES



- Panel Options: Open panel, Panel with straps, Fabric Panel, Fabric Panel with Acoustic Filling
- Can be combined with modules or modules with panels
- Offer acoustic and visual privacy
- Leg and frame in black (RAL7021)
- Diameter of foot 30 cm
- Upholstery available in various fabrics. For recommendations, please contact your sales representative











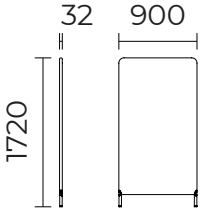
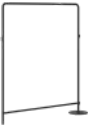
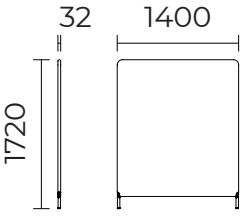

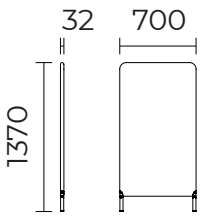
For product information visit oceefour.com ↗

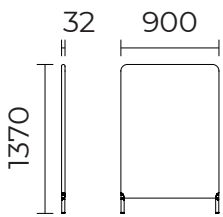
For full band and colour details [go to page 238](#) ↗

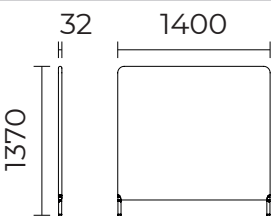
| Product | Description (Item nr) | Weight (Kg) | Dimensions (mm) | Band | Standard (SEK) |
|---------|---------------------------------------------------------------------|-------------|-----------------|------|----------------|
| | PEG2131 FourPeople Panel, Add on, W: 700, H: 1370, Frame | - | 32 700 1370 | - | 8.121 |
| | PEG2231 FourPeople Panel, Add on, W: 900, H: 1370, Frame | - | 32 900 1370 | - | 8.327 |
| | PEG2331 FourPeople Panel, Add on, W: 1400, H: 1370, Frame | - | 32 1400 1370 | - | 8.837 |
| | PEG2141 FourPeople Panel, Add on, W: 700, H: 1720, Frame | - | 32 700 1720 | - | 8.364 |

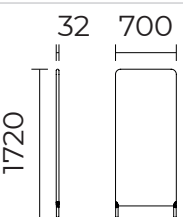
FourPeople Add on panels

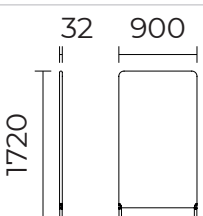
Design by Nørgaard Design

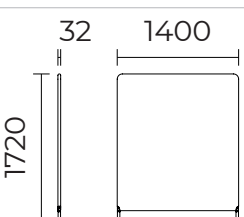
| Product | Description (Item nr) | Weight (Kg) | Dimensions (mm) | Band | Standard (SEK) |
|-------------------------------------------------------------------------------------|----------------------------------------------------------------------|-------------|-------------------------------------------------------------------------------------|------|----------------|
|  | PEG2241 FourPeople Panel, Add on, W: 900, H: 1720, Frame | - |  | - | 8.424 |
|  | PEG2341 FourPeople Panel, Add on, W: 1400, H: 1720, Frame | - |  | - | 9.116 |
|  | PEG2132 FourPeople Panel, Add on, W: 700, H: 1370, Straps | - |  | - | 9.068 |
|  | PEG2232 FourPeople Panel, Add on, W: 900, H: 1370, Straps | - |  | - | 9.529 |
|  | PEG2332 FourPeople Panel, Add on, W: 1400, H: 1370, Straps | - |  | - | 10.791 |
|  | PEG2142 FourPeople Panel, Add on, W: 700, H: 1720, Straps | - |  | - | 9.298 |
|  | PEG2242 FourPeople Panel, Add on, W: 900, H: 1720, Straps | - |  | - | 9.674 |
|  | PEG2342 FourPeople Panel, Add on, W: 1400, H: 1720, Straps | - |  | - | 11.131 |

FourPeople Add on panels

[Content ↗](#)



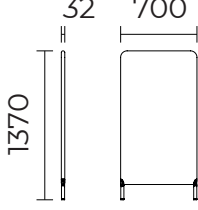
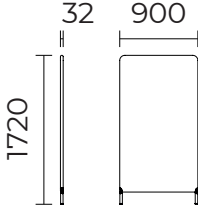
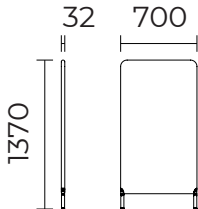



Design by Nørgaard Design

| Product | Description (Item nr) | Weight (Kg) | Dimensions (mm) | Band | Standard (SEK) |
|-------------------------------------------------------------------------------------|-----------------------------------------------------------------------------------------|-------------|-------------------------------------------------------------------------------------|---------------------------------|--------------------------------------------------------------------|
|  | PEG2133 FourPeople Panel, Add on, W: 700, H: 1370, Fabric | - |  | 1 2 3 4 5 6 7 | 8.654 8.969 9.309 10.039 10.379 10.633 11.495 |
|  | PEG2233 FourPeople Panel, Add on, W: 900, H: 1370, Fabric | - |  | 1 2 3 4 5 6 7 | 9.007 9.407 9.832 10.754 11.191 11.507 12.599 |
|  | PEG2333 FourPeople Panel, Add on, W: 1400, H: 1370, Fabric | - |  | 1 2 3 4 5 6 7 | 9.869 10.476 11.131 12.551 13.194 13.680 15.354 |
|  | PEG2143 FourPeople Panel, Add on, W: 700, H: 1720, Fabric | - |  | 1 2 3 4 5 6 7 | 9.140 9.614 10.099 11.180 11.677 12.042 13.316 |
|  | PEG2243 FourPeople Panel, Add on, W: 900, H: 1720, Fabric | - |  | 1 2 3 4 5 6 7 | 9.420 10.014 10.646 12.005 12.636 13.109 14.724 |
|  | PEG2343 FourPeople Panel, Add on, W: 1400, H: 1720, Fabric | - |  | 1 2 3 4 5 6 7 | 10.633 11.543 12.514 14.614 15.573 16.290 18.777 |
|  | PEG2134 FourPeople Panel, Add on, W: 700, H: 1370, Fabric with acoustic | - |  | 1 2 3 4 5 6 7 | 9.868 10.183 10.522 11.253 11.592 11.847 12.709 |
|  | PEG2234 FourPeople Panel, Add on, W: 900, H: 1370, Fabric with acoustic | - |  | 1 2 3 4 5 6 7 | 10.343 10.743 11.168 12.090 12.527 12.843 13.935 |

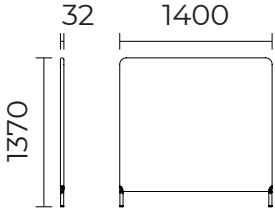
FourPeople Add on panels

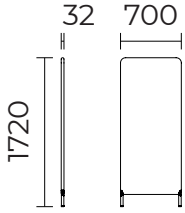
[Content ↗](#)

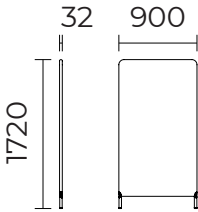
Design by Nørgaard Design

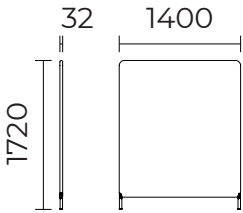
| Product | Description (Item nr) | Weight (Kg) | Dimensions (mm) | Band | Standard (SEK) |
|-------------------------------------------------------------------------------------|------------------------------------------------------------------------------------------|-------------|------------------------------------------------------------------------------------|---------------------------------|--------------------------------------------------------------------|
|  | PEG2334 FourPeople Panel, Add on, W: 1400, H: 1370, Fabric with acoustic | - |  | 1 2 3 4 5 6 7 | 12.224 12.831 13.485 14.906 15.548 16.035 17.709 |
|  | PEG2144 FourPeople Panel, Add on, W: 700, H: 1720, Fabric with acoustic | - |  | 1 2 3 4 5 6 7 | 10.743 11.217 11.702 12.783 13.280 13.644 14.918 |
|  | PEG2244 FourPeople Panel, Add on, W: 900, H: 1720, Fabric with acoustic | - |  | 1 2 3 4 5 6 7 | 11.750 12.344 12.976 14.335 14.966 15.439 17.054 |
|  | PEG2344 FourPeople Panel, Add on, W: 1400, H: 1720, Fabric with acoustic | - |  | 1 2 3 4 5 6 7 | 15.161 16.070 17.042 19.142 20.100 20.817 23.305 |

| ACCESSORIES | Description | Weight (Kg) | Dimensions (mm) | Band | Price (SEK) |
|-------------------------------------------------------------------------------------|------------------------------------|-------------|-----------------|------|-------------|
|  | FOURPEOPLE HOOK ACC1001 | 0,1 kg | | | 126 |

FourPeople Work Booth

Design by Nørgaard Design

[Content ↗](#)



FEATURES







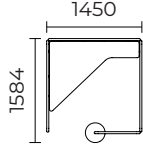

- Work Booth in various configurations.
- Closed concentrated work area with acoustic and visual privacy.
- Two heights 1370 cm or 1720 cm.
- Including table top in two heights: Standing 105 cm or sitting 74 cm.
- Black Nano laminate 21 mm table top with impact resistant ABS edges. Leg in black (RAL7021).
- Electrical units are optional and will be positioned in the centre of tables as standard.
- Upholstery available in various fabrics. For recommendations, please contact your sales representative

For product information visit oceefour.com ↗

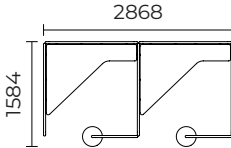
For electrical accessories [go to page 228](#) ↗

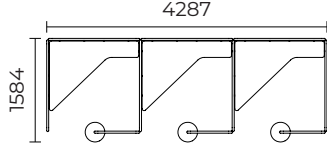
For full band and colour details [go to page 238](#) ↗

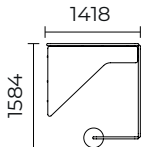
| Product | Description (Item nr) | Weight (Kg) | Dimensions (mm) | Band | Price (SEK) |
|-------------------------------------------------------------------------------------|------------------------------------------------------------------|-------------|--------------------------------------------------------------------------------------|-------------------------------------------------------------------------------------------------------------------------------------------------------------------------------|-------------|
|  | PEJ13 FourPeople Single Work Booth, 1 Booth, H: 1370 | 119.1 |  | <ul style="list-style-type: none"> 1 49.021 2 51.206 3 53.511 4 58.536 5 60.855 6 62.579 7 68.525 | |
|  | PEJ23 FourPeople Single Work Booth, 2 Booth, H: 1370 | 205.4 |  | <ul style="list-style-type: none"> 1 87.898 2 91.647 3 95.628 4 104.270 5 108.251 6 111.200 7 121.432 | |
|  | PEJ33 FourPeople Single Work Booth, 3 Booth, H: 1370 | 291.7 |  | <ul style="list-style-type: none"> 1 126.906 2 132.221 3 137.865 4 150.111 5 155.755 6 159.943 7 174.446 | |
|  | PEJX3 FourPeople Single Work Booth, Extension, H: 1370 | 86.3 |  | <ul style="list-style-type: none"> 1 39.761 2 41.328 3 42.991 4 46.607 5 48.270 6 49.507 7 53.780 | |

FourPeople Work Booth

[Content ↗](#)







Design by Nørgaard Design

| Product | Description (Item nr) | Weight (Kg) | Dimensions (mm) | Band | Price (SEK) |
|-------------------------------------------------------------------------------------|------------------------------------------------------------------|-------------|--------------------------------------------------------------------------------------|-------------------------------------------------------------------------------------------------------------------------------------------------------------------------------|-------------|
|  | PEK13 FourPeople Double Work Booth, 1 Booth, H: 1370 | - |  | <ul style="list-style-type: none"> 1 88.128 2 91.879 3 95.859 4 104.488 5 108.469 6 111.431 7 121.662 | |
|  | PEK23 FourPeople Double Work Booth, 2 Booth, H: 1370 | 205.4 |  | <ul style="list-style-type: none"> 1 156.642 2 162.916 3 169.568 4 184.010 5 190.661 6 195.600 7 212.714 | |
|  | PEK33 FourPeople Double Work Booth, 3 Booth, H: 1370 | - |  | <ul style="list-style-type: none"> 1 234.416 2 243.202 3 252.536 4 272.792 5 282.113 6 289.043 7 313.027 | |
|  | PEKX3 FourPeople Double Work Booth, Extension, H: 1370 | 139.7 |  | <ul style="list-style-type: none"> 1 69.837 2 72.362 3 75.032 4 80.846 5 83.516 6 85.506 7 92.388 | |
|  | PEJ14 FourPeople Single Work Booth, 1 Booth, H: 1720 | - |  | <ul style="list-style-type: none"> 1 51.692 2 52.142 3 54.459 4 59.484 5 61.803 6 63.513 7 69.473 | |
|  | PEJ24 FourPeople Single Work Booth, 2 Booth, H: 1720 | - |  | <ul style="list-style-type: none"> 1 92.703 2 98.237 3 104.100 4 116.844 5 122.706 6 127.064 7 142.148 | |
|  | PEJ34 FourPeople Single Work Booth, 3 Booth, H: 1720 | - |  | <ul style="list-style-type: none"> 1 133.727 2 141.568 3 149.881 4 167.940 5 176.254 6 182.432 7 203.817 | |
|  | PEJX4 FourPeople Single Work Booth, Extension, H: 1720 | - |  | <ul style="list-style-type: none"> 1 41.777 2 44.095 3 46.535 4 51.862 5 54.314 6 56.135 7 62.433 | |

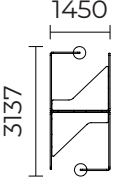
FourPeople Work Booth

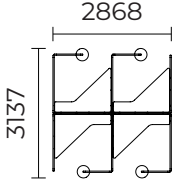
[Content ↗](#)

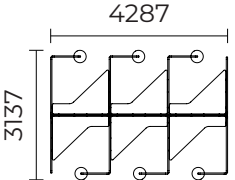
Design by Nørgaard Design

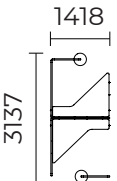
| Product | Description (Item nr) | Weight (Kg) | Dimensions (mm) | Band | Price (SEK) |
|------------------------------------------------------------------------------------|------------------------------------------------------------------|-------------|------------------------------------------------------------------------------------|-------------------------------------------------------------------------------------------------------------------------------------------------------------------------------|----------------|
|  | PEK14 FourPeople Double Work Booth, 1 Booth, H: 1720 | - |  | <ul style="list-style-type: none"> 1 92.935 2 98.469 3 104.331 4 117.062 5 122.936 6 127.294 7 142.380 | |
|  | PEK24 FourPeople Double Work Booth, 2 Booth, H: 1720 | - |  | <ul style="list-style-type: none"> 1 164.713 2 173.961 3 183.755 4 205.031 5 214.837 6 222.107 7 247.317 | |
|  | PEK34 FourPeople Double Work Booth, 3 Booth, H: 1720 | - |  | <ul style="list-style-type: none"> 1 236.831 2 249.780 3 263.520 4 293.340 5 307.066 6 317.274 7 352.580 | |
|  | PEKX4 FourPeople Double Work Booth, Extension, H: 1720 | - |  | <ul style="list-style-type: none"> 1 73.114 2 76.816 3 80.748 4 89.294 5 93.225 6 96.150 7 106.261 | |

| ACCESSORIES | Description | Weight (Kg) | Dimensions (mm) | Band | Price (SEK) |
|-------------------------------------------------------------------------------------|------------------------------------|-------------|-----------------|------|-------------|
|  | FOURPEOPLE HOOK ACC1001 | 0,1 kg | | | 126 |

FourPeople Study Booth

Design by Nørgaard Design

[Content ↗](#)



FEATURES



- Study Booth in various configurations.
- Private touch down area with acoustic and visual privacy.
- Two heights 1370 or 1720 cm.
- Including table top in two heights: Standing 105 cm or sitting 74 cm.
- Black Nano laminate 21 mm table top with impact resistant ABS edges. Leg in standard black (RAL7021).
- Electrical units are optional and will be positioned in the centre of tables as standard.
- Upholstery available in various fabrics. For recommendations, please contact your sales representative.

For product information visit oceefour.com ↗

For electrical accessories [go to page 228](#) ↗

For full band and colour details [go to page 238](#) ↗

| Product | Description (Item nr) | Weight (Kg) | Dimensions (mm) | Band | Price (SEK) |
|---------|-------------------------------------------------------------------|-------------|-----------------|------------------------------------------------------------------------------------------------------------------------------------------------------------------------|-------------|
| | PEH13 FourPeople Single Study Booth, 1 Booth, H: 1370 | 71.6 | | <ul style="list-style-type: none"> 1 30.270 2 31.546 3 32.892 4 35.817 5 37.165 6 38.172 7 41.631 | |
| | PEH23 FourPeople Single Study Booth, 2 Booth, H: 1370 | 123.8 | | <ul style="list-style-type: none"> 1 47.227 2 53.198 3 55.443 4 60.322 5 62.580 6 64.242 7 70.020 | |
| | PEH33 FourPeople Single Study Booth, 3 Booth, H: 1370 | 174.5 | | <ul style="list-style-type: none"> 1 70.906 2 73.866 3 77.022 4 83.855 5 86.999 6 89.329 7 97.425 | |
| | PEHX3 FourPeople Single Study Booth, Extension, H: 1370 | 50.7 | | <ul style="list-style-type: none"> 1 21.581 2 22.431 3 23.328 4 25.270 5 26.181 6 26.848 7 29.154 | |

FourPeople Study Booth

[Content ↗](#)







Design by Nørgaard Design

| Product | Description (Item nr) | Weight (Kg) | Dimensions (mm) | Band | Price (SEK) |
|------------------------------------------------------------------------------------|-------------------------------------------------------------------|-------------|--------------------------------------------------------------------------------------|---------------------------------|---------------------------------------------------------------------------|
|  | PEI13 FourPeople Double Study Booth, 1 Booth, H: 1370 | 121.9 |  | 1 2 3 4 5 6 7 | 49.969 52.094 54.339 59.217 61.464 63.137 68.916 |
|  | PEI23 FourPeople Double Study Booth, 2 Booth, H: 1370 | 202.8 |  | 1 2 3 4 5 6 7 | 81.792 83.917 86.162 91.040 93.285 94.961 100.737 |
|  | PEI33 FourPeople Double Study Booth, 3 Booth, H: 1370 | - |  | 1 2 3 4 5 6 7 | 117.839 122.499 127.451 138.181 143.132 146.798 159.517 |
|  | PEIX3 FourPeople Double Study Booth, Extension, H: 1370 | 79 |  | 1 2 3 4 5 6 7 | 34.591 35.866 37.213 40.139 41.485 42.492 45.964 |
|  | PEH14 FourPeople Single Study Booth, 1 Booth, H: 1720 | - |  | 1 2 3 4 5 6 7 | 31.618 33.536 35.550 39.944 41.970 43.476 48.670 |
|  | PEH24 FourPeople Single Study Booth, 2 Booth, H: 1720 | - |  | 1 2 3 4 5 6 7 | 54.751 58.780 63.053 72.325 76.598 79.765 90.750 |
|  | PEH34 FourPeople Single Study Booth, 3 Booth, H: 1720 | - |  | 1 2 3 4 5 6 7 | 76.136 81.647 87.484 100.180 106.018 110.362 125.388 |
|  | PEHX4 FourPeople Single Study Booth, Extension, H: 1720 | - |  | 1 2 3 4 5 6 7 | 23.899 26.010 28.257 33.147 35.392 37.055 42.844 |

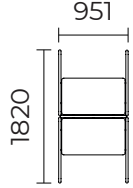
FourPeople Study Booth

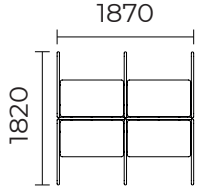
[Content ↗](#)

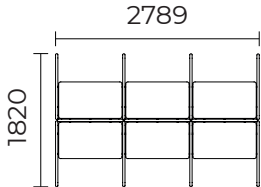
Design by Nørgaard Design

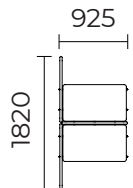
| Product | Description (Item nr) | Weight (Kg) | Dimensions (mm) | Band | Price (SEK) |
|-------------------------------------------------------------------------------------|-------------------------------------------------------------------|-------------|------------------------------------------------------------------------------------|-----------------------------------------------------------------------------------------------------------------------|-----------------------------------------------------------------------------------------------------------------------------------------------------------------|
|  | PEI14 FourPeople Double Study Booth, 1 Booth, H: 1720 | - |  | <ul style="list-style-type: none"> 1 2 3 4 5 6 7 | <ul style="list-style-type: none"> 52.227 55.406 58.780 66.099 69.473 71.973 80.651 |
|  | PEI24 FourPeople Double Study Booth, 2 Booth, H: 1720 | - |  | <ul style="list-style-type: none"> 1 2 3 4 5 6 7 | <ul style="list-style-type: none"> 86.744 91.829 97.218 108.931 114.332 118.336 132.209 |
|  | PEI34 FourPeople Double Study Booth, 3 Booth, H: 1720 | - |  | <ul style="list-style-type: none"> 1 2 3 4 5 6 7 | <ul style="list-style-type: none"> 121.722 128.727 136.142 152.247 159.664 165.173 184.240 |
|  | PEIX4 FourPeople Double Study Booth, Extension, H: 1720 | - |  | <ul style="list-style-type: none"> 1 2 3 4 5 6 7 | <ul style="list-style-type: none"> 35.951 37.857 39.883 44.277 46.292 47.796 53.003 |

| ACCESSORIES | Description | Weight (Kg) | Dimensions (mm) | Band | Price (SEK) |
|-------------------------------------------------------------------------------------|--------------------------------|-------------|-----------------|------|-------------|
|  | FOURPEOPLE HOOK ACC1001 | 0,1 kg | | | 126 |

FourPeople Work Hut

Design by Nørgaard Design

[Content ↗](#)



FEATURES



- Private touch down area with acoustic and visual privacy.
- Including table top in two heights: Standing 105 cm or sitting 74 cm, right or left side.
- Black Nano laminate 21 mm table top with impact resistant ABS edges. Leg in black (RAL7021).
- Electrical units are optional and will be positioned in the centre of tables as standard.
- Upholstery available in various fabrics. For recommendations, please contact your sales representative.

For product information visit oceefour.com ↗

For electrical accessories [go to page 228](#) ↗

For full band and colour details [go to page 238](#) ↗

| Product | Description (Item nr) | Weight (Kg) | Dimensions (mm) | Band | Price (SEK) | | | | | | | | | | | | | | |
|---------|----------------------------------------------------|-------------|-----------------|----------------------------------------------------------------------------------------------------------------------------------------------------------------------------------------------------------------------------------------------------------------------------------|-------------|--------|---|--------|---|--------|---|--------|---|--------|---|--------|---|--------|--|
| | PEM3L FourPeople Work Hut, Fabric, Left | - | | <table border="1"> <tr><td>1</td><td>42.432</td></tr> <tr><td>2</td><td>45.891</td></tr> <tr><td>3</td><td>49.555</td></tr> <tr><td>4</td><td>57.506</td></tr> <tr><td>5</td><td>61.170</td></tr> <tr><td>6</td><td>63.890</td></tr> <tr><td>7</td><td>73.307</td></tr> </table> | 1 | 42.432 | 2 | 45.891 | 3 | 49.555 | 4 | 57.506 | 5 | 61.170 | 6 | 63.890 | 7 | 73.307 | |
| 1 | 42.432 | | | | | | | | | | | | | | | | | | |
| 2 | 45.891 | | | | | | | | | | | | | | | | | | |
| 3 | 49.555 | | | | | | | | | | | | | | | | | | |
| 4 | 57.506 | | | | | | | | | | | | | | | | | | |
| 5 | 61.170 | | | | | | | | | | | | | | | | | | |
| 6 | 63.890 | | | | | | | | | | | | | | | | | | |
| 7 | 73.307 | | | | | | | | | | | | | | | | | | |
| | PEM3R FourPeople Work Hut, Fabric, Right | - | | <table border="1"> <tr><td>1</td><td>42.432</td></tr> <tr><td>2</td><td>45.891</td></tr> <tr><td>3</td><td>49.555</td></tr> <tr><td>4</td><td>57.506</td></tr> <tr><td>5</td><td>61.170</td></tr> <tr><td>6</td><td>63.890</td></tr> <tr><td>7</td><td>73.307</td></tr> </table> | 1 | 42.432 | 2 | 45.891 | 3 | 49.555 | 4 | 57.506 | 5 | 61.170 | 6 | 63.890 | 7 | 73.307 | |
| 1 | 42.432 | | | | | | | | | | | | | | | | | | |
| 2 | 45.891 | | | | | | | | | | | | | | | | | | |
| 3 | 49.555 | | | | | | | | | | | | | | | | | | |
| 4 | 57.506 | | | | | | | | | | | | | | | | | | |
| 5 | 61.170 | | | | | | | | | | | | | | | | | | |
| 6 | 63.890 | | | | | | | | | | | | | | | | | | |
| 7 | 73.307 | | | | | | | | | | | | | | | | | | |

| ACCESSORIES | Description | Weight (Kg) | Dimensions (mm) | Band | Price (SEK) |
|-------------|-----------------------------------|-------------|-----------------|------|-------------|
| | FOURPEOPLE HOOK ACCT001 | 0,1 kg | | | 126 |

FourPeople Sofa Hut

Design by Nørgaard Design

[Content](#) ↗



FEATURES



- Provide a relaxed and sociable space with acoustic and visual privacy.
- Comes in low or high back with straps or fabric.
- Two tone fabric options available.
- Electrical units are optional and will be positioned on the left or right side of sofas as standard.
- Leg in black (RAL7021).
- Upholstery available in various fabrics. For recommendations, please contact your sales representative.

For product information visit oceefour.com ↗

For electrical accessories [go to page 228](#) ↗

For full band and colour details [go to page 238](#) ↗

| Product | Description (Item nr) | Weight (Kg) | Dimensions (mm) | Band | Price (SEK) |
|---------|--------------------------------------------------------|-------------|-----------------|------------------------------------------------------------------------------------------------------------------------------------------------------------------------|-------------|
| | PEL2H FourPeople Sofa Hut, Straps, High back | 70 | | <ul style="list-style-type: none"> 1 49.969 2 50.879 3 51.850 4 53.950 5 54.921 6 55.636 7 58.125 | |
| | PEL2L FourPeople Sofa Hut, Straps, Low back | 41.6 | | <ul style="list-style-type: none"> 1 47.190 2 47.869 3 48.585 4 50.151 5 50.866 6 51.400 7 53.246 | |
| | PEL3H FourPeople Sofa Hut, Fabric, High back | - | | <ul style="list-style-type: none"> 1 48.257 2 52.420 3 56.827 4 66.390 5 70.795 6 74.061 7 85.396 | |
| | PEL3L FourPeople Sofa Hut, Fabric, Low back | - | | <ul style="list-style-type: none"> 1 45.477 2 49.398 3 53.548 4 62.579 5 66.742 6 69.825 7 80.517 | |





FourLikes®



FourLikes® Meet



FourLikes® Scooter |
Wheels



FourLikes® Scooter



FourLikes® Wall bench









FEATURES



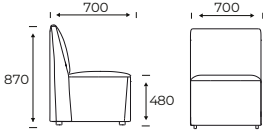

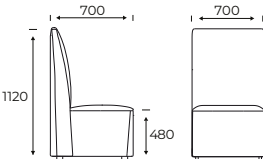

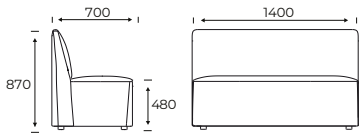

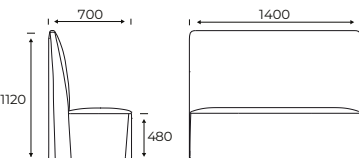

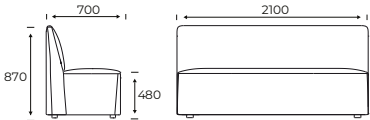

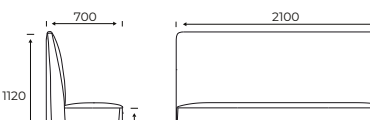

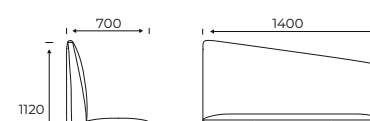
- Modular and flexible system. Modules in different lengths.
- Low and high back modules. Uni- or Multicoloured.
- Active seat height 48 cm (fits table height 74 cm).
- Frame delivered as standard in black.
- Electrical units are optional and will be positioned on the left or right side of sofas as standard.

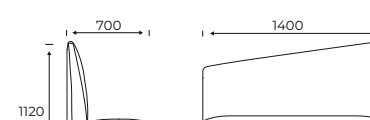
For product information visit oceefour.com ↗

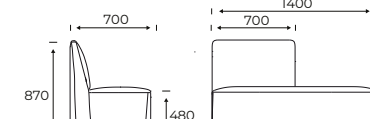



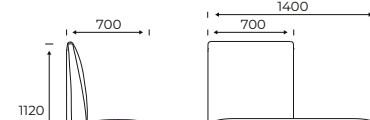

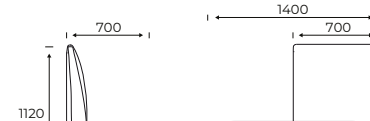
For electrical accessories [go to page 228](#) ↗

For full band and colour details [go to page 238](#) ↗

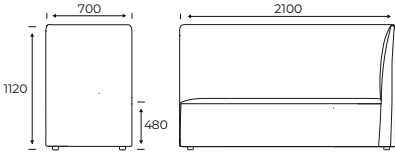
| Product | Description (Item nr) | Weight (Kg) | Dimensions (mm) | Band | Same colour (SEK) | Different seat colour (SEK) |
|------------------------------------------------------------------------------------|----------------------------------------------|-------------|--------------------------------------------------------------------------------------|-----------------------|------------------------------------------------|----------------------------------------------------|
|  | 700000 FourLikes®, Low back, 700 | 20,5 Kg |  | 1 2 3 4 5 | 9.859 11.146 12.437 13.724 15.014 | 2.152 2.656 3.379 3.964 4.610 6.770 |
|  | 700010 FourLikes®, High back, 700 | 21,5 Kg |  | 1 2 3 4 5 | 11.079 12.653 14.228 15.804 17.381 | 2.152 2.656 3.379 3.964 4.610 6.770 |
|  | 700001 FourLikes®, Low back, 1400 | 41,3 Kg |  | 1 2 3 4 5 | 13.144 14.864 16.581 18.298 20.018 | 2.982 3.681 4.685 5.494 6.393 9.388 |
|  | 700011 FourLikes®, High back, 1400 | 42,5 Kg |  | 1 2 3 4 5 | 14.772 16.873 18.973 21.072 23.173 | 2.982 3.681 4.685 5.494 6.393 9.388 |

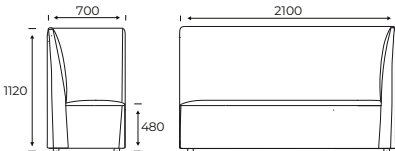
| Product | Description (Item nr) | Weight (Kg) | Dimensions (mm) | Band | Same colour (SEK) | Different seat colour (SEK) |
|------------------------------------------------------------------------------------|-------------------------------------------------------------------|-------------|--------------------------------------------------------------------------------------|-----------------------|------------------------------------------------|-----------------------------------------------------|
|  | 700002 FourLikes®, Low back, 2100 | - |  | 1 2 3 4 5 | 21.031 23.781 26.531 29.282 32.031 | 4.589 5.665 7.210 8.452 9.840 14.445 |
|  | 700012 FourLikes®, High back, 2100 | - |  | 1 2 3 4 5 | 23.635 26.994 30.355 33.716 37.077 | 4.589 5.665 7.210 8.452 9.840 14.445 |
|  | 700021 FourLikes®, Slope, High Back Right, 1400 | - |  | 1 2 3 4 5 | 15.777 17.878 19.978 22.077 24.179 | 2.982 3.681 4.685 5.494 6.393 9.388 |
|  | 700031 FourLikes®, Slope, High Back Left, 1400 | - |  | 1 2 3 4 5 | 15.777 17.878 19.978 22.077 24.179 | 2.982 3.681 4.685 5.494 6.393 9.388 |
|  | 700041 FourLikes®, Open End Left, Low Back Right, 1400 | 45,5 Kg |  | 1 2 3 4 5 | 14.808 16.069 17.328 18.588 19.850 | 2.982 3.681 4.685 5.494 6.393 9.388 |
|  | 700051 FourLikes®, Open End Right, Low Back Left, 1400 | 45,6 Kg |  | 1 2 3 4 5 | 14.808 16.069 17.328 18.588 19.850 | 2.982 3.681 4.685 5.494 6.393 9.388 |
|  | 700061 FourLikes®, Open End Left, High Back Right, 1400 | 46,8 Kg |  | 1 2 3 4 5 | 16.844 18.592 20.337 22.084 23.831 | 2.982 3.681 4.685 5.494 6.393 9.388 |
|  | 700071 FourLikes®, Open End Right, High Back Left, 1400 | 46,8 Kg |  | 1 2 3 4 5 | 16.844 18.592 20.337 22.084 23.831 | 2.982 3.681 4.685 5.494 6.393 9.388 |

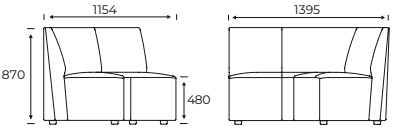
| Product | Description (Item nr) | Weight (Kg) | Dimensions (mm) | Band | Same colour (SEK) | Different seat colour (SEK) |
|------------------------------------------------------------------------------------|------------------------------------------------------------|-------------|--------------------------------------------------------------------------------------|-----------------------|------------------------------------------------|-----------------------------------------------------|
|  | 700100 FourLikes®, Corner, Low back, 700 | 20,8 Kg |  | 1 2 3 4 5 | 12.979 14.343 15.706 17.072 18.436 | 2.152 2.656 3.379 3.964 4.610 6.770 |
|  | 700110 FourLikes®, Corner, High back, 700 | 27,3 Kg |  | 1 2 3 4 5 | 14.868 17.073 19.281 21.487 23.694 | 2.152 2.656 3.379 3.964 4.610 6.770 |
|  | 700191 FourLikes®, Corner, Low Back Right, 1400 | 45,3 Kg |  | 1 2 3 4 5 | 15.269 16.873 18.477 20.082 21.685 | 2.982 3.681 4.685 5.494 6.393 9.388 |
|  | 700181 FourLikes®, Corner, Low Back Left, 1400 | 45,3 Kg |  | 1 2 3 4 5 | 15.269 16.873 18.477 20.082 21.685 | 2.982 3.681 4.685 5.494 6.393 9.388 |
|  | 7001B1 FourLikes®, Corner, High Back Right, 1400 | 50,4 Kg |  | 1 2 3 4 5 | 18.191 20.893 23.592 26.292 28.995 | 2.982 3.681 4.685 5.494 6.393 9.388 |
|  | 7001A1 FourLikes®, Corner, High Back Left, 1400 | 50,4 Kg |  | 1 2 3 4 5 | 18.191 20.893 23.592 26.292 28.995 | 2.982 3.681 4.685 5.494 6.393 9.388 |
|  | 700192 FourLikes®, Corner, Low Back Right, 2100 | 66,9 Kg |  | 1 2 3 4 5 | 24.430 26.999 29.564 32.130 34.697 | 4.589 5.665 7.210 8.452 9.840 14.445 |
|  | 700182 FourLikes®, Corner, Low Back Left, 2100 | 66,9 Kg |  | 1 2 3 4 5 | 24.430 26.999 29.564 32.130 34.697 | 4.589 5.665 7.210 8.452 9.840 14.445 |

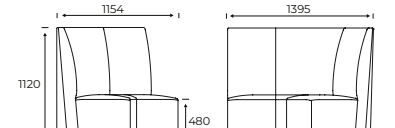
| Product | Description (Item nr) | Weight (Kg) | Dimensions (mm) | Band | Same colour (SEK) | Different seat colour (SEK) |
|------------------------------------------------------------------------------------|------------------------------------------------------------|-------------|--------------------------------------------------------------------------------------|-----------------------|------------------------------------------------|-----------------------------------------------------|
|  | 7001B2 FourLikes®, Corner, High Back Right, 2100 | 77,8 Kg |  | 1 2 3 4 5 | 27.986 32.142 36.297 40.452 44.606 | 4.589 5.665 7.210 8.452 9.840 14.445 |
|  | 7001A2 FourLikes®, Corner, High Back Left, 2100 | 77,8 Kg |  | 1 2 3 4 5 | 27.986 32.142 36.297 40.452 44.606 | 4.589 5.665 7.210 8.452 9.840 14.445 |
|  | 7000E7 FourLikes®, Convex 120 Low back, 1350 | |  | 1 2 3 4 5 | 21.632 22.898 25.605 26.864 29.387 | 4.721 5.453 6.956 7.756 9.031 13.242 |
|  | 7000F7 FourLikes®, Convex 120 High back, 1350 | 35 kg |  | 1 2 3 4 5 | 23.078 24.402 27.404 28.846 31.669 | 4.721 5.453 6.956 7.756 9.031 13.242 |
|  | 7000C1 FourLikes®, Concave 120 Low back, 1400 | 35,5 Kg |  | 1 2 3 4 5 | 23.017 24.402 27.342 28.662 31.372 | 5.023 5.810 7.427 8.275 9.642 14.136 |
|  | 7000D1 FourLikes®, Concave 120 High back, 1400 | 38,5 Kg |  | 1 2 3 4 5 | 25.840 27.342 30.592 32.095 35.098 | 5.023 5.810 7.427 8.275 9.642 14.136 |



FEATURES

- Modular and flexible system. Uni- or Multicoloured.
- Acoustic and visual privacy.
- Active seat height 48 cm (fits table height 74 cm).
- Table top: 70x70cm or 120x70 cm
- Table top in black, warm grey or anthracite Nano laminate
- Electrical units are optional and will be positioned in the centre of tables as standard.

For product information visit oceefour.com ↗

TABLE TOP

Fenix laminate



FRAME COLOURS

Standard



For electrical accessories [go to page 228](#) ↗



For full band and colour details [go to page 238](#) ↗

| Product | Description (Item nr) | Weight (Kg) | Dimensions (mm) | Band | Same colour (SEK) | Different colour (SEK) |
|---------|----------------------------------------|-------------|-----------------|----------------------------|------------------------------------------------|-----------------------------------------------------|
| | 70120 FourLikes® Meet, 700 | 152 Kg | | 1 2 3 4 5 | 44.124 49.738 55.351 60.965 66.580 | |
| | 70120-S FourLikes® Meet, 700 | | | 1 2 3 4 5 8 | | 4.474 5.753 7.032 8.313 9.592 13.429 |
| | 70120-T FourLikes® Meet, 700 | | | 1 2 3 4 5 8 | | 6.304 7.098 7.889 8.681 9.472 11.850 |
| | 70121 FourLikes® Meet, 1400 | 183 Kg | | 1 2 3 4 5 | 58.829 66.314 73.798 81.283 88.768 | |

FourLikes® Meet

Design by Nørgaard Design

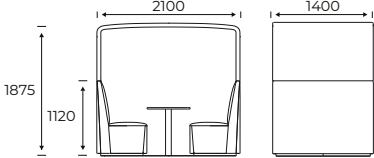
[Content ↗](#)

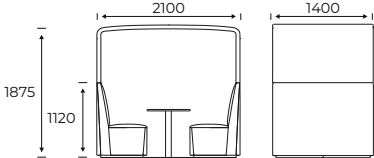
| Product | Description (Item nr) | Weight (Kg) | Dimensions (mm) | Band | Same colour (SEK) | Different colour (SEK) |
|----------------------------------------------------------------------------------|-----------------------------------------|-------------|------------------------------------------------------------------------------------|----------------------------|-------------------|--------------------------------------------------------|
|  | 70121-S FourLikes® Meet, 1400 | |  | 1 2 3 4 5 8 | | 5.966 7.366 9.376 10.988 12.791 18.777 |
|  | 70121-T FourLikes® Meet, 1400 | |  | 1 2 3 4 5 8 | | 8.404 9.475 10.544 11.612 12.682 18.027 |

| ACCESSORIES | Description | Weight (Kg) | Dimensions (mm) | Price (SEK) |
|-------------|--------------|-------------|-----------------|-------------|
| | With Linking | | | 263 |

FourLikes® Scooter | Wheels

Design by Nørgaard Design

[Content](#) ↗







FEATURES

- Scooter including wheels
- Single back or double back options
- Active seat height 48 cm (Fits table height 74 cm)

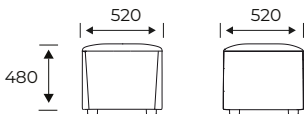
For product information visit oceefour.com ↗

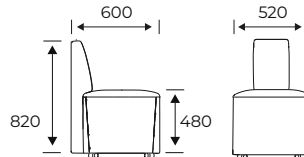
For full band and colour details [go to page 238](#) ↗

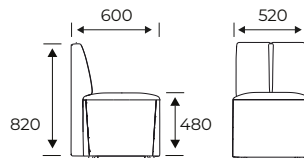
| Product | Description (Item nr) | Weight (Kg) | Dimensions (mm) | Band | Same colour (SEK) | | | | | | | | | | | | |
|------------------------------------------------------------------------------------|-------------------------------------------------------------------------------|-------------|-------------------------------------------------------------------------------------|----------------------------------------------------------------------------------------------------------------------------------------------------------------------------------------------------------------------------------------------|-------------------|-------|---|--------|---|--------|---|--------|---|--------|---|--------|--|
|  | 7024030-W FourLikes® Scooter, Straight, 530, Without backs, Castors | 9,5 Kg |  | <table border="1"> <tr><td>1</td><td>6.102</td></tr> <tr><td>2</td><td>6.618</td></tr> <tr><td>3</td><td>7.137</td></tr> <tr><td>4</td><td>7.652</td></tr> <tr><td>5</td><td>8.167</td></tr> <tr><td>8</td><td>10.752</td></tr> </table> | 1 | 6.102 | 2 | 6.618 | 3 | 7.137 | 4 | 7.652 | 5 | 8.167 | 8 | 10.752 | |
| 1 | 6.102 | | | | | | | | | | | | | | | | |
| 2 | 6.618 | | | | | | | | | | | | | | | | |
| 3 | 7.137 | | | | | | | | | | | | | | | | |
| 4 | 7.652 | | | | | | | | | | | | | | | | |
| 5 | 8.167 | | | | | | | | | | | | | | | | |
| 8 | 10.752 | | | | | | | | | | | | | | | | |
|  | 702403A-W FourLikes® Scooter, Straight, 530, 1 single back, Castors | 11,6 Kg |  | <table border="1"> <tr><td>1</td><td>8.040</td></tr> <tr><td>2</td><td>8.721</td></tr> <tr><td>3</td><td>9.405</td></tr> <tr><td>4</td><td>10.084</td></tr> <tr><td>5</td><td>10.764</td></tr> <tr><td>8</td><td>14.172</td></tr> </table> | 1 | 8.040 | 2 | 8.721 | 3 | 9.405 | 4 | 10.084 | 5 | 10.764 | 8 | 14.172 | |
| 1 | 8.040 | | | | | | | | | | | | | | | | |
| 2 | 8.721 | | | | | | | | | | | | | | | | |
| 3 | 9.405 | | | | | | | | | | | | | | | | |
| 4 | 10.084 | | | | | | | | | | | | | | | | |
| 5 | 10.764 | | | | | | | | | | | | | | | | |
| 8 | 14.172 | | | | | | | | | | | | | | | | |
|  | 7024031-W FourLikes® Scooter, Straight, 530, 1 double back, Castors | 13,4 Kg |  | <table border="1"> <tr><td>1</td><td>9.328</td></tr> <tr><td>2</td><td>10.035</td></tr> <tr><td>3</td><td>10.744</td></tr> <tr><td>4</td><td>11.449</td></tr> <tr><td>5</td><td>12.157</td></tr> <tr><td>8</td><td>15.696</td></tr> </table> | 1 | 9.328 | 2 | 10.035 | 3 | 10.744 | 4 | 11.449 | 5 | 12.157 | 8 | 15.696 | |
| 1 | 9.328 | | | | | | | | | | | | | | | | |
| 2 | 10.035 | | | | | | | | | | | | | | | | |
| 3 | 10.744 | | | | | | | | | | | | | | | | |
| 4 | 11.449 | | | | | | | | | | | | | | | | |
| 5 | 12.157 | | | | | | | | | | | | | | | | |
| 8 | 15.696 | | | | | | | | | | | | | | | | |









FEATURES

- FourLikes Scooter including legs.
- Single back or double back options.
- Active seat height 48 cm (fits table height 74 cm).
- Only FourLikes Scooter 1400/2100: Electrical units are optional and will be positioned on the left or right side of sofas as standard.

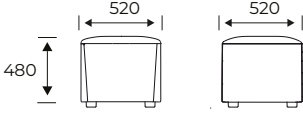

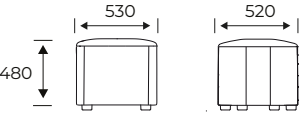
For product information visit oceefour.com ↗

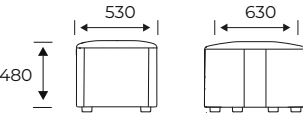

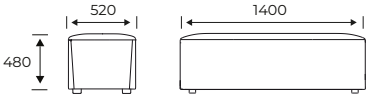
For full band and colour details [go to page 238](#) ↗

| Product | Description (Item nr) | Weight (Kg) | Dimensions (mm) | Band | Same colour (SEK) |
|-------------------------------------------------------------------------------------|---------------------------------------------------------------------|-------------|--------------------------------------------------------------------------------------|----------------------------|---------------------------------------------------------|
|  | 7024030 FourLikes® Scooter, Straight, 530, Without backs | 9,5 Kg |  | 1 2 3 4 5 8 | 5.326 5.842 6.361 6.876 7.391 9.976 |
|  | 7024130 FourLikes® Scooter, 45 degree, 530, Without backs | 9,7 Kg |  | 1 2 3 4 5 8 | 5.889 6.462 7.033 7.606 8.180 11.040 |
|  | 7024230 FourLikes® Scooter, 90 degree, 530, Without backs | 10,4 Kg |  | 1 2 3 4 5 8 | 6.773 7.431 8.088 8.745 9.400 12.686 |
|  | 7024010 FourLikes® Scooter, Straight, 1400, Without backs | 26,4 Kg |  | 1 2 3 4 5 8 | 9.554 11.044 12.531 14.024 15.511 22.959 |

FourLikes® Scooter

Design by Nørsgaard Design

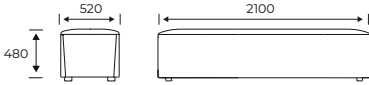
[Content ↗](#)

| Product | Description (Item nr) | Weight (Kg) | Dimensions (mm) | Band | Same colour (SEK) |
|-----------------------------------------------------------------------------------|---------------------------------------------------------------------|-------------|------------------------------------------------------------------------------------|----------------------------|----------------------------------------------------------|
|  | 7024020 FourLikes® Scooter, Straight, 2100, Without backs | 40,5 Kg |  | 1 2 3 4 5 8 | 10.560 12.049 13.536 15.029 16.517 23.962 |
|  | 7024XXA FourLikes® Scooter, Straight, 1400, 1 single back | 2,1 Kg | | 1 2 3 4 5 8 | 1.938 2.103 2.268 2.432 2.597 3.420 |
|  | 7024XX1 FourLikes® Scooter, Straight, 1400, 1 double back | 3,9 Kg | | 1 2 3 4 5 8 | 3.226 3.417 3.607 3.797 3.990 4.944 |

| ACCESSORIES | Description | Weight (Kg) | Dimensions (mm) | Price (SEK) |
|-------------|--------------|-------------|-----------------|-------------|
| | With Linking | | | 416 |

FourLikes® Wall bench

Design by Nørgaard Design

[Content ↗](#)











FEATURES

- Wall-mounted (We recommend a sitting height of 46-48 cm.)
- Compact footprint for utilisation of all square metres
- We recommend at least two brackets per 140 cm
- We recommend a max. load of 150 kg. per 2 brackets as well as mounting on concrete/brick wall
- Backrest is supplied with a vertical wall mount bracket
- The seat is delivered without screws and brackets



For product information visit oceefour.com ↗









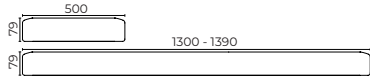

For full band and colour details [go to page 238](#) ↗

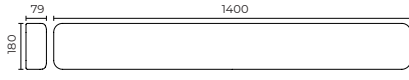
| Product | Description (Item nr) | Weight (Kg) | Dimensions (mm) | Band | Same colour (SEK) | | | | | | | | | | | | |
|------------------------------------------------------------------------------------|---------------------------------------------------------|-------------|--------------------------------------------------------------------------------------|------------------------------------------------------------------------------------------------------------------------------------------------------------------------------------------------------------------------------------------|-------------------|-------|---|-------|---|-------|---|-------|---|-------|---|--------|--|
|  | 70331I FourLikes® Wall Bench, Seat, 1400 | 9,2 Kg |  | <table border="1"> <tr><td>1</td><td>4.577</td></tr> <tr><td>2</td><td>5.460</td></tr> <tr><td>3</td><td>6.344</td></tr> <tr><td>4</td><td>7.228</td></tr> <tr><td>5</td><td>8.112</td></tr> <tr><td>8</td><td>12.526</td></tr> </table> | 1 | 4.577 | 2 | 5.460 | 3 | 6.344 | 4 | 7.228 | 5 | 8.112 | 8 | 12.526 | |
| 1 | 4.577 | | | | | | | | | | | | | | | | |
| 2 | 5.460 | | | | | | | | | | | | | | | | |
| 3 | 6.344 | | | | | | | | | | | | | | | | |
| 4 | 7.228 | | | | | | | | | | | | | | | | |
| 5 | 8.112 | | | | | | | | | | | | | | | | |
| 8 | 12.526 | | | | | | | | | | | | | | | | |
|  | 70331A FourLikes® Wall Bench, Seat, 1000-1090 | (6,5 Kg) |  | <table border="1"> <tr><td>1</td><td>5.099</td></tr> <tr><td>2</td><td>5.923</td></tr> <tr><td>3</td><td>6.750</td></tr> <tr><td>4</td><td>7.575</td></tr> <tr><td>5</td><td>8.398</td></tr> <tr><td>8</td><td>12.524</td></tr> </table> | 1 | 5.099 | 2 | 5.923 | 3 | 6.750 | 4 | 7.575 | 5 | 8.398 | 8 | 12.524 | |
| 1 | 5.099 | | | | | | | | | | | | | | | | |
| 2 | 5.923 | | | | | | | | | | | | | | | | |
| 3 | 6.750 | | | | | | | | | | | | | | | | |
| 4 | 7.575 | | | | | | | | | | | | | | | | |
| 5 | 8.398 | | | | | | | | | | | | | | | | |
| 8 | 12.524 | | | | | | | | | | | | | | | | |
|  | 70331B FourLikes® Wall Bench, Seat, 1100-1190 | (7,2 Kg) |  | <table border="1"> <tr><td>1</td><td>5.282</td></tr> <tr><td>2</td><td>6.152</td></tr> <tr><td>3</td><td>7.021</td></tr> <tr><td>4</td><td>7.891</td></tr> <tr><td>5</td><td>8.760</td></tr> <tr><td>8</td><td>13.107</td></tr> </table> | 1 | 5.282 | 2 | 6.152 | 3 | 7.021 | 4 | 7.891 | 5 | 8.760 | 8 | 13.107 | |
| 1 | 5.282 | | | | | | | | | | | | | | | | |
| 2 | 6.152 | | | | | | | | | | | | | | | | |
| 3 | 7.021 | | | | | | | | | | | | | | | | |
| 4 | 7.891 | | | | | | | | | | | | | | | | |
| 5 | 8.760 | | | | | | | | | | | | | | | | |
| 8 | 13.107 | | | | | | | | | | | | | | | | |
|  | 70331C FourLikes® Wall Bench, Seat, 1200-1290 | (7,9 Kg) |  | <table border="1"> <tr><td>1</td><td>5.466</td></tr> <tr><td>2</td><td>6.389</td></tr> <tr><td>3</td><td>7.311</td></tr> <tr><td>4</td><td>8.233</td></tr> <tr><td>5</td><td>9.154</td></tr> <tr><td>8</td><td>13.763</td></tr> </table> | 1 | 5.466 | 2 | 6.389 | 3 | 7.311 | 4 | 8.233 | 5 | 9.154 | 8 | 13.763 | |
| 1 | 5.466 | | | | | | | | | | | | | | | | |
| 2 | 6.389 | | | | | | | | | | | | | | | | |
| 3 | 7.311 | | | | | | | | | | | | | | | | |
| 4 | 8.233 | | | | | | | | | | | | | | | | |
| 5 | 9.154 | | | | | | | | | | | | | | | | |
| 8 | 13.763 | | | | | | | | | | | | | | | | |

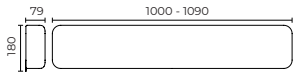
FourLikes® Wall bench

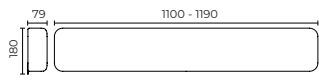
Design by Nørsgaard Design

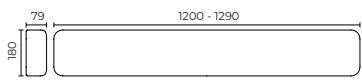
[Content ↗](#)

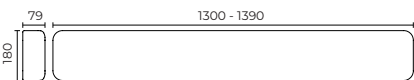
| Product | Description (Item nr) | Weight (Kg) | Dimensions (mm) | Band | Same colour (SEK) |
|------------------------------------------------------------------------------------|-------------------------------------------------------------|-------------|--------------------------------------------------------------------------------------|----------------------------|-----------------------------------------------------|
|  | 70331D FourLikes® Wall Bench, Seat, 1300-1390 | (8,5 Kg) |  | 1 2 3 4 5 8 | 5.588 6.562 7.533 8.504 9.476 14.338 |
|  | 703321 FourLikes® Wall Bench, Backrest, 1400 | 2,6 Kg |  | 1 2 3 4 5 8 | 5.382 6.204 7.026 7.846 8.667 12.775 |
|  | 70332A FourLikes® Wall Bench, Backrest, 1000-1090 | (1,8 Kg) |  | 1 2 3 4 5 8 | 4.951 5.594 6.235 6.876 7.519 10.727 |
|  | 70332B FourLikes® Wall Bench, Backrest, 1100-1190 | (2 Kg) |  | 1 2 3 4 5 8 | 5.094 5.775 6.459 7.142 7.823 11.235 |
|  | 70332C FourLikes® Wall Bench, Backrest, 1200-1290 | (2,2 Kg) |  | 1 2 3 4 5 8 | 5.168 5.900 6.633 7.366 8.098 11.760 |
|  | 70332D FourLikes® Wall Bench, Backrest, 1300-1390 | (2,4 Kg) |  | 1 2 3 4 5 8 | 5.310 6.084 6.860 7.636 8.410 12.285 |

| ACCESSORIES | Description | Weight (Kg) | Dimensions (mm) | Price (SEK) |
|-------------------------------------------------------------------------------------|--------------|-------------|-----------------|-------------|
|  | With Bracket | | | 1.507 |







FourUs®



FourUs® Booth



FourUs® Booth 2



FourUs® Work Booth



FourUs® Solo



FourUs® 3-Seater



FourUs® Wallpod



FourUs® Worx



FEATURES







- Acoustic and visual privacy
- Linking options
- Uni- or Multicolored
- Facility friendly; designed for optimal cleaning
- Optional: Castors, Skid frame, InnoTab tablet, Magazine holder, Shelf (height 95 cm).
- Electrical units are optional and will be positioned on the left or right side of sofas as standard.



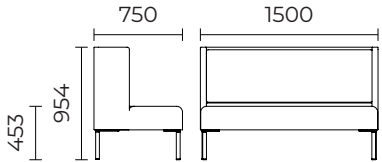

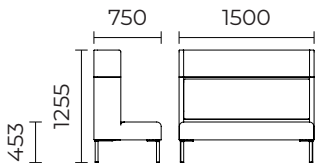

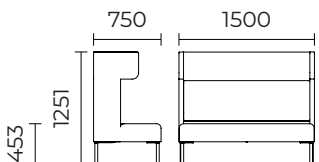

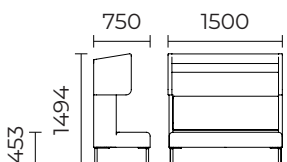

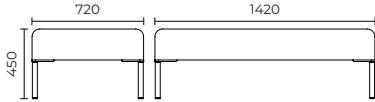
For product information visit oceefour.com ↗

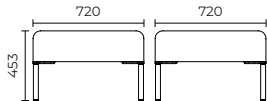
For electrical accessories [go to page 228](#) ↗

For full band and colour details [go to page 238](#) ↗

| Product | Description (Item nr) | Weight (Kg) | Dimensions (mm) | Band | Same colour (SEK) | Different colour (SEK) |
|------------------------------------------------------------------------------------|------------------------------------|-------------|--------------------------------------------------------------------------------------|----------------------------|----------------------------------------------------------|------------------------|
|  | 80000 FourUs®, Bench | 52 kg |  | 1 2 3 4 5 8 | 19.880 21.785 23.319 24.773 28.463 52.361 | |
|  | 80001 FourUs®, Extension | 64 kg |  | 1 2 3 4 5 8 | 24.812 26.944 28.659 30.263 34.884 64.583 | |
|  | 80002 FourUs®, Ear | 58 kg |  | 1 2 3 4 5 8 | 26.176 28.020 29.648 31.472 36.690 66.569 | |
|  | 80003 FourUs®, Cave | 70 kg |  | 1 2 3 4 5 8 | 30.253 32.423 34.440 36.461 43.179 81.938 | |

| Product | Description (Item nr) | Weight (Kg) | Dimensions (mm) | Band | Same colour (SEK) | Different colour (SEK) |
|-------------------------------------------------------------------------------------|-------------------------------------------|-------------|------------------------------------------------------------------------------------|----------------------------|----------------------------------------------------------|-----------------------------------------------------|
|  | 80004 FourUs®, Daybed | 25 kg |  | 1 2 3 4 5 8 | 10.081 10.767 11.310 11.897 13.693 21.514 | |
|  | 80005 FourUs®, Stool | 16 kg |  | 1 2 3 4 5 8 | 8.064 8.778 9.184 9.789 10.484 13.894 | |
|  | 80000-S FourUs®, Bench, Seat | | | 1 2 3 4 5 8 | | 2.574 3.176 4.044 4.739 5.517 8.097 |
|  | 80000-C FourUs®, Bench, Cushion | | | 1 2 3 4 5 8 | | 2.574 2.996 3.052 3.297 3.534 5.753 |
|  | 80001-T FourUs®, Extension, Top | | | 1 2 3 4 5 8 | | 1.807 1.986 2.505 3.033 3.554 4.963 |
|  | 80002-T FourUs®, Ear, Top | | | 1 2 3 4 5 8 | | 2.210 2.791 3.522 4.091 4.802 6.835 |
|  | 80003-T FourUs®, Cave, Top | | | 1 2 3 4 5 8 | | 4.058 5.215 6.344 7.313 8.448 10.504 |

| ACCESSORIES | Description | Weight (Kg) | Dimensions (mm) | Price (SEK) |
|-------------------------------------------------------------------------------------|---------------------------------------------------------------------------|-------------|-----------------|-------------|
|  | FOURUS LEGS Castors | | | 3,960 |
|  | FOURUS LEGS Skid frame | | | 3,742 |
|  | 160800L InnoTab, FourUs, Left | | | 3,872 |
|  | 160800R InnoTab, FourUs, Right | | | 3,872 |
|  | 899010 FourUs® Optional Extras, Magazine holder black, 30 cm | 4,9 Kg | 300 x 352 mm | 1,089 |
|  | 899020 FourUs® Optional Extras, Magazine holder black, 70 cm | 5,6 Kg | 700 x 325 mm | 1,484 |
|  | 899100 FourUs® Optional Extras, Shelf black | 5,8 Kg | L1412 mm | 5,949 |



FEATURES





- Private working area for 4 people. Acoustic and visual privacy.
- Uni- or multicoloured.
- Facility friendly; designed for optimal cleaning.
- Optional: Pivot table that effortlessly moves both horizontally and vertically (Nano laminate: Warm grey, Anthracite or Black).
- Frame and fittings in black, matt lacquered.
- Optional: Skid frame, Magazine holder, Shelf (height 95 cm) TV bracket.
- Electrical units are optional in sofa and in tabletop.





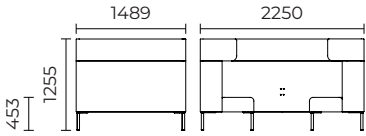



For product information visit oceefour.com ↗

For electrical accessories [go to page 228](#) ↗

For full band and colour details [go to page 238](#) ↗

| Product | Description (Item nr) | Weight (Kg) | Dimensions (mm) | Band | Same colour (SEK) | Different colour (SEK) |
|------------------------------------------------------------------------------------|----------------------------------------------|-------------|--------------------------------------------------------------------------------------|----------------------------|------------------------------------------------|------------------------------------------------------|
|  | 81002 FourUs® Booth, | 154 kg |  | 1 2 3 4 5 | 60.327 65.121 69.465 74.247 78.807 | |
|  | 81002-S FourUs® Booth, 2 x Seat | | | 1 2 3 4 5 8 | | 5.146 5.961 7.945 9.565 11.189 16.057 |
|  | 81002-C FourUs® Booth, 2 x Cushion | | | 1 2 3 4 5 8 | | 5.146 5.644 6.096 6.595 7.610 10.443 |
|  | 81002-T FourUs® Booth, Top | | | 1 2 3 4 5 8 | | 4.421 4.860 5.239 5.841 6.901 11.322 |

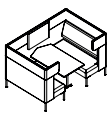
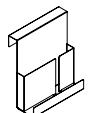
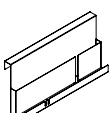
| Product | Description (Item nr) | Weight (Kg) | Dimensions (mm) | Band | Same colour (SEK) | Different colour (SEK) |
|----------------------------------------------------------------------------------|---------------------------------------|-------------|-----------------|------|-------------------|------------------------|
|  | 81003-C FourUs® Booth, Cave | | | 1 | | 14.221 |
| | | | | 2 | | 17.442 |
| | | | | 3 | | 20.649 |
| | | | | 4 | | 23.267 |
| | | | | 5 | | 27.608 |

| ACCESSORIES | Description | Weight (Kg) | Dimensions (mm) | Price (SEK) |
|-------------------------------------------------------------------------------------|-------------------------------------------------------------------------------|-------------|----------------------|-------------|
| | CABLE MANAGEMENT Pre-drilled hole in wall for cables for TV | | | 345 |
| | CABLE MANAGEMENT Fabric with velcro for concealing cable-right side | | | 781 |
| | CABLE MANAGEMENT Fabric with velcro for concealing cable, left side | | | 781 |
|  | FOURUS LEGS Skid frame | | | 3.742 |
|  | 160800L InnoTab, FourUs, Left | | | 3.872 |
|  | 160800R InnoTab, FourUs, Right | | | 3.872 |
|  | 8501 FourUs® Pivot Table, Pivot table 138x75 (FourUs Booth) | 30,6 Kg | 1388 x 750 x h720 mm | 11.047 |
|  | 899001 FourUs® Optional Extras, TV bracket | - | | 3.176 |
|  | 899010 FourUs® Optional Extras, Magazine holder black, 30 cm | 4,9 Kg | 300 x 352 mm | 1.089 |
|  | 899020 FourUs® Optional Extras, Magazine holder black, 70 cm | 5,6 Kg | 700 x 325 mm | 1.484 |
|  | 899100 FourUs® Optional Extras, Shelf black | 5,8 Kg | L1412 mm | 5.949 |

FourUs® Booth 2

Design by Nørgaard Design

[Content ↗](#)



FEATURES





- Private working area for 2 people. Acoustic and visual privacy.
- Uni- or multicoloured.
- Facility friendly; designed for optimal cleaning.
- Optional: Pivot table that effortlessly moves both horizontally and vertically (Nano laminate: Warm grey, Anthracite or Black).
- Frame and fittings in black, matt lacquered.
- Optional: Skid frame, Magazine holder, Shelf (h 95 cm) TV bracket.
- Electrical units are optional in sofa and in tabletop.





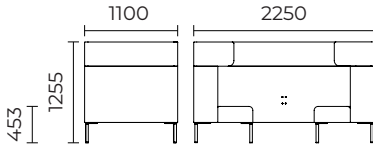

For product information visit oceefour.com ↗

For electrical accessories [go to page 228](#) ↗

For full band and colour details [go to page 238](#) ↗

| Product | Description (Item nr) | Weight (Kg) | Dimensions (mm) | Band | Same colour (SEK) | Different colour (SEK) |
|------------------------------------------------------------------------------------|------------------------------------------------|-------------|--------------------------------------------------------------------------------------|----------------------------|------------------------------------------------|-----------------------------------------------------|
|  | 81042 FourUs® Booth 2, | - |  | 1 2 3 4 5 | 48.260 52.098 55.574 59.397 63.046 | |
|  | 81042-S FourUs® Booth 2, 2 x Seat | | | 1 2 3 4 5 8 | | 4.530 5.244 6.993 8.419 9.848 14.133 |
|  | 81042-C FourUs® Booth 2, 2 x Cushion | | | 1 2 3 4 5 8 | | 4.530 4.967 5.366 5.806 6.695 9.189 |
|  | 81042-T FourUs® Booth 2, Top | | | 1 2 3 4 5 8 | | 3.890 4.276 4.610 5.139 4.276 4.610 |

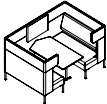
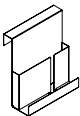
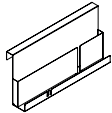
| ACCESSORIES | Description | Weight (Kg) | Dimensions (mm) | Price (SEK) |
|-------------------------------------------------------------------------------------|-------------------------------------------------------------------------------|-------------|-----------------|-------------|
| | CABLE MANAGEMENT Pre-drilled hole in wall for cables for TV | | | 345 |
| | CABLE MANAGEMENT Fabric with velcro for concealing cable-right side | | | 781 |
| | CABLE MANAGEMENT Fabric with velcro for concealing cable, left side | | | 781 |
|  | FOURUS LEGS Skid frame | | | 3.742 |
|  | 160800L InnoTab, FourUs, Left | | | 3.872 |
|  | 160800R InnoTab, FourUs, Right | | | 3.872 |
|  | 8502 FourUs® Pivot Table, Pivot table 99x75 (FourUs Booth 2) | - | | 11.047 |
|  | 899001 FourUs® Optional Extras, TV bracket | - | | 3.176 |
|  | 899010 FourUs® Optional Extras, Magazine holder black, 30 cm | 4,9 Kg | 300 x 352 mm | 1.089 |
|  | 899020 FourUs® Optional Extras, Magazine holder black, 70 cm | 5,6 Kg | 700 x 325 mm | 1.484 |



FEATURES





- Private working area for 1-3 people. Acoustic and visual privacy.
- Delivered left or right-handed. Uni- or multicoloured.
- Facility friendly; designed for optimal cleaning.
- Optional: Pivot table that effortlessly moves both horizontally and vertically (Nano laminate: Warm grey, Anthracite or Black).
- Frame and fittings in black, matt lacquered.
- Optional: Skid frame, Magazine holder, Shelf (h 95 cm) TV bracket.
- Electrical units are optional in sofa and in tabletop.

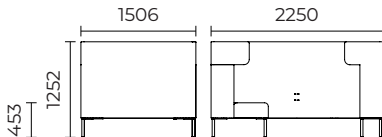

For product information visit oceefour.com ↗

For electrical accessories [go to page 228](#) ↗

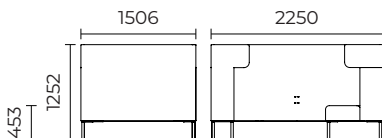



For full band and colour details [go to page 238](#) ↗





| Product | Description (Item nr) | Weight (Kg) | Dimensions (mm) | Band | Same colour (SEK) | Different colour (SEK) |
|------------------------------------------------------------------------------------|--------------------------------------------------|-------------|--------------------------------------------------------------------------------------|----------------------------|------------------------------------------------|----------------------------------------------------|
|  | 87062 FourUs® Work Booth right, | 154 kg |  | 1 2 3 4 5 | 50.711 55.821 60.930 66.040 71.149 | |
|  | 87072 FourUs® Work Booth left, | 154 kg |  | 1 2 3 4 5 | 50.711 55.821 60.930 66.040 71.149 | |
|  | 87062-S FourUs® Work Booth right, Seat | | | 1 2 3 4 5 8 | | 2.574 2.981 3.973 4.784 5.597 8.030 |
|  | 87072-S FourUs® Work Booth left, Seat | | | 1 2 3 4 5 8 | | 2.574 2.981 3.973 4.784 5.597 8.030 |

FourUs® Work Booth

Design by Nørgaard Design

[Content ↗](#)

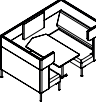
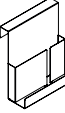
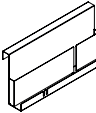
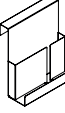
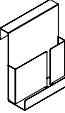
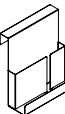
| Product | Description (Item nr) | Weight (Kg) | Dimensions (mm) | Band | Same colour (SEK) | Different colour (SEK) |
|------------------------------------------------------------------------------------|--------------------------------------------------------|-------------|-----------------|------|----------------------|---------------------------|
|  | 87062-C FourUs® Work Booth right, Cushion | | | 1 | | 2.574 |
| | | | | 2 | | 2.823 |
| | | | | 3 | | 3.050 |
| | | | | 4 | | 3.297 |
| | | | | 5 | | 3.805 |
| | | | | 8 | | 5.222 |
|  | 87072-C FourUs® Work Booth left, Cushion | | | 1 | | 2.574 |
| | | | | 2 | | 2.823 |
| | | | | 3 | | 3.050 |
| | | | | 4 | | 3.297 |
| | | | | 5 | | 3.805 |
| | | | | 8 | | 5.222 |
|  | 87062-T FourUs® Work Booth right, Top | | | 1 | | 4.421 |
| | | | | 2 | | 4.860 |
| | | | | 3 | | 5.239 |
| | | | | 4 | | 5.841 |
| | | | | 5 | | 6.901 |
| | | | | 8 | | 11.322 |
|  | 87072-T FourUs® Work Booth left, Top | | | 1 | | 4.421 |
| | | | | 2 | | 4.860 |
| | | | | 3 | | 5.239 |
| | | | | 4 | | 5.841 |
| | | | | 5 | | 6.901 |
| | | | | 8 | | 11.322 |

| ACCESSORIES | Description | Weight (Kg) | Dimensions (mm) | Price (SEK) |
|-------------------------------------------------------------------------------------|-------------------------------------------------------------------------------|-------------|----------------------|-------------|
| | CABLE MANAGEMENT Pre-drilled hole in wall for cables for TV | | | 345 |
| | CABLE MANAGEMENT Fabric with velcro for concealing cable-right side | | | 781 |
| | CABLE MANAGEMENT Fabric with velcro for concealing cable, left side | | | 781 |
|  | 8503 FourUs® Pivot Table, Pivot table (FourUs Work Booth) right | 22,9 Kg | 1361 x 842 x H720 mm | 11.047 |
|  | 8504 FourUs® Pivot Table, Pivot table (FourUs Work Booth) left | 22,9 Kg | 1361 x 842 x H720 mm | 11.047 |
|  | 899001 FourUs® Optional Extras, TV bracket | - | | 3.176 |
|  | 899010 FourUs® Optional Extras, Magazine holder black, 30 cm | 4,9 Kg | 300 x 352 mm | 1.089 |
|  | 899020 FourUs® Optional Extras, Magazine holder black, 70 cm | 5,6 Kg | 700 x 325 mm | 1.484 |
|  | 899030 FourUs® Optional Extras, Magazine holder black, 22,5 cm | - | | 2.839 |
|  | 899040 FourUs® Optional Extras, Magazine holder white, 22,5 cm | - | | 2.839 |
|  | 899050 FourUs® Optional Extras, Magazine holder grey, 22,5 cm | - | | 2.839 |
|  | 899100 FourUs® Optional Extras, Shelf black | 5,8 Kg | L1412 mm | 5.949 |

FourUs® Solo

Design by Nørgaard Design

[Content ↗](#)



FEATURES





- Acoustic and visual privacy. Uni- or multicoloured.
- Facility friendly; designed for optimal cleaning.
- Inclusive black Fenix-laminate tablet (21 mm) – placed on the right side as standard.
- Standard leg frame black (RAL 7021). Optional: Castors or Skid frame.
- Electrical units are optional and will be positioned on the left or right side of sofas as standard.

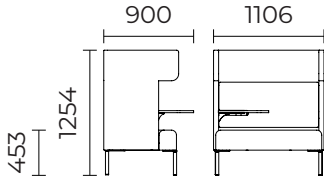

For product information visit oceefour.com ↗

For electrical accessories [go to page 228](#) ↗



For full band and colour details [go to page 238](#) ↗

| Product | Description (Item nr) | Weight (Kg) | Dimensions (mm) | Band | Same colour (SEK) | Different colour (SEK) |
|------------------------------------------------------------------------------------|-----------------------------------------------------------|-------------|-------------------------------------------------------------------------------------|----------------------------|----------------------------------------------------------|----------------------------------------------------|
|  | 80016 FourUs® Solo with black tablet, | 64 kg |  | 1 2 3 4 5 8 | 25.783 27.601 29.203 31.004 36.139 65.571 | |
|  | 80016-S FourUs® Solo with black tablet, Seat | | | 1 2 3 4 5 8 | | 2.512 2.923 2.975 3.218 3.451 6.683 |
|  | 80016-C FourUs® Solo with black tablet, Cushion | | | 1 2 3 4 5 8 | | 2.512 2.923 2.975 3.218 3.451 6.683 |
|  | 80016-T FourUs® Solo with black tablet, Top | | | 1 2 3 4 5 8 | | 2.337 3.093 3.786 4.564 5.269 7.450 |

FourUs® Solo

Design by Nørgaard Design

[Content ↗](#)

| ACCESSORIES | Description | Weight (Kg) | Dimensions (mm) | Price (SEK) |
|-----------------------------------------------------------------------------------|----------------------------------|-------------|-----------------|-------------|
|  | FOURUS LEGS Castors | | | 3.960 |
|  | FOURUS LEGS Skid frame | | | 3.742 |

FourUs® 3-Seater

Design by Nørgaard Design

[Content ↗](#)



FEATURES







- Acoustic and visual privacy. Uni- or Multicoloured.
- Facility friendly; designed for optimal cleaning.
- Optional: Skid frame, InnoTab tablet, Magazine holder, Shelf (height 95 cm).
- Electrical units are optional and will be positioned on the left or right side of sofas as standard.

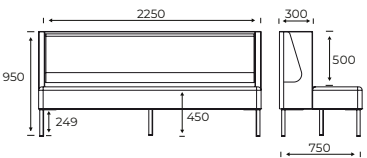

For product information visit oceefour.com ↗

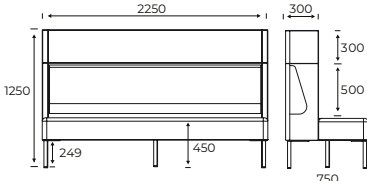
For electrical accessories [go to page 228](#) ↗

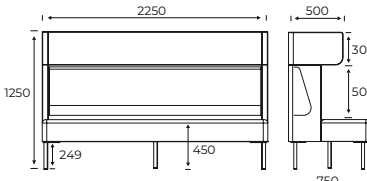

For full band and colour details [go to page 238](#) ↗

| Product | Description (Item nr) | Weight (Kg) | Dimensions (mm) | Band | Same colour (SEK) | Different colour (SEK) |
|------------------------------------------------------------------------------------|-------------------------------------------------|-------------|-------------------------------------------------------------------------------------|----------------------------|----------------------------------------------------------|----------------------------------------------------|
|  | 80030 FourUs® 3-Seater, Bench | - |  | 1 2 3 4 5 8 | 29.253 31.129 32.817 34.692 38.441 55.882 | |
|  | 80031 FourUs® 3-Seater, Extension | - |  | 1 2 3 4 5 8 | 34.562 36.567 38.253 39.849 44.536 66.478 | |
|  | 80032 FourUs® 3-Seater, Ear | 62 Kg |  | 1 2 3 4 5 8 | 35.817 37.878 39.567 41.289 45.849 67.788 | |
|  | 80030-S FourUs® 3-Seater, Bench, Seat | | | 1 2 3 4 5 8 | | 3.095 4.078 4.855 5.822 6.778 9.901 |

FourUs® 3-Seater

Design by Nørgaard Design

[Content ↗](#)

| Product | Description (Item nr) | Weight (Kg) | Dimensions (mm) | Band | Same colour (SEK) | Different colour (SEK) |
|-----------------------------------------------------------------------------------|----------------------------------------------------|-------------|-----------------|------|-------------------|------------------------|
|  | 80030-C FourUs® 3-Seater, Bench, Cushion | | | 1 | | 2.774 |
| | | | | 2 | | 2.993 |
| | | | | 3 | | 3.121 |
| | | | | 4 | | 3.392 |
| | | | | 5 | | 3.562 |
| | | | | 8 | | 6.315 |
|  | 80031-T FourUs® 3-Seater, Extension, Top | | | 1 | | 2.776 |
| | | | | 2 | | 2.993 |
| | | | | 3 | | 3.544 |
| | | | | 4 | | 4.339 |
| | | | | 5 | | 5.138 |
| | | | | 8 | | 7.502 |
|  | 80032-T FourUs® 3-Seater, Ear, Top | | | 1 | | 2.776 |
| | | | | 2 | | 2.993 |
| | | | | 3 | | 3.544 |
| | | | | 4 | | 4.339 |
| | | | | 5 | | 5.138 |
| | | | | 8 | | 7.502 |

| ACCESSORIES | Description | Weight (Kg) | Dimensions (mm) | Price (SEK) |
|-------------------------------------------------------------------------------------|------------------------------------------------------------------------|-------------|-----------------|-------------|
|  | FOURUS LEGS Skid frame | | | 3.742 |
|  | 160800L InnoTab, FourUs, Left | | | 3.872 |
|  | 160800R InnoTab, FourUs, Right | | | 3.872 |
|  | 899010 FourUs® Optional Extras, Magazine holder black, 30 cm | 4,9 Kg | 300 x 352 mm | 1.089 |
|  | 899020 FourUs® Optional Extras, Magazine holder black, 70 cm | 5,6 Kg | 700 x 325 mm | 1.484 |



FEATURES

- Acoustic and visual privacy
- Touch-Down-workspace (1 Person)
- Table top in: Black, warm grey or anthracite Nano laminate (138x50 cm)
- Matching ABS edges



For product information visit oceefour.com ↗

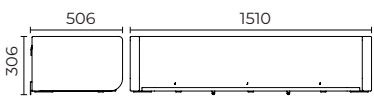

TABLE TOP

Fenix laminate



07 08 09

For full band and colour details [go to page 238](#) ↗

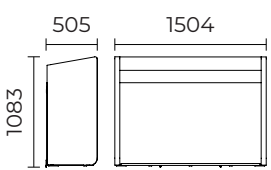
| Product | Description (Item nr) | Weight (Kg) | Dimensions (mm) | Band | Same colour (SEK) | | | | | | | | | | | | |
|------------------------------------------------------------------------------------|-----------------------------------------------|-------------|--------------------------------------------------------------------------------------|-----------------------------------------------------------------------------------------------------------------------------------------------------------------------------------------------------------------------------------------------|-------------------|--------|---|--------|---|--------|---|--------|---|--------|---|--------|--|
|  | 8200E FourUs® Wallpod, Wallpod Ear | 29 kg |  | <table border="1"> <tr><td>1</td><td>9.656</td></tr> <tr><td>2</td><td>10.198</td></tr> <tr><td>3</td><td>10.667</td></tr> <tr><td>4</td><td>11.182</td></tr> <tr><td>5</td><td>11.675</td></tr> <tr><td>8</td><td>16.518</td></tr> </table> | 1 | 9.656 | 2 | 10.198 | 3 | 10.667 | 4 | 11.182 | 5 | 11.675 | 8 | 16.518 | |
| 1 | 9.656 | | | | | | | | | | | | | | | | |
| 2 | 10.198 | | | | | | | | | | | | | | | | |
| 3 | 10.667 | | | | | | | | | | | | | | | | |
| 4 | 11.182 | | | | | | | | | | | | | | | | |
| 5 | 11.675 | | | | | | | | | | | | | | | | |
| 8 | 16.518 | | | | | | | | | | | | | | | | |
|  | 8200F FourUs® Wallpod, Wallpod Cave | 35 kg |  | <table border="1"> <tr><td>1</td><td>17.477</td></tr> <tr><td>2</td><td>19.096</td></tr> <tr><td>3</td><td>20.571</td></tr> <tr><td>4</td><td>22.193</td></tr> <tr><td>5</td><td>23.741</td></tr> <tr><td>8</td><td>41.609</td></tr> </table> | 1 | 17.477 | 2 | 19.096 | 3 | 20.571 | 4 | 22.193 | 5 | 23.741 | 8 | 41.609 | |
| 1 | 17.477 | | | | | | | | | | | | | | | | |
| 2 | 19.096 | | | | | | | | | | | | | | | | |
| 3 | 20.571 | | | | | | | | | | | | | | | | |
| 4 | 22.193 | | | | | | | | | | | | | | | | |
| 5 | 23.741 | | | | | | | | | | | | | | | | |
| 8 | 41.609 | | | | | | | | | | | | | | | | |



FEATURES

- Table height 74 cm – integrated castors on two legs.
- Foldable by one person without the use of tools.
- Tabletop 98 x 65 cm.
- Table top in: Black, warm gray or anthracite Nano laminate.
- Matching ABS edges.
- Electrical units are optional in tabletop.

For product information visit oceefour.com ↗

TABLE TOP

Fenix laminate



07 08 09

FRAME COLOURS

Standard



6 B C K

For electrical accessories [go to page 228](#) ↗

For full colour details [go to page 236](#) ↗

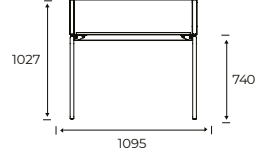
| Product | Description (Item nr) | Weight (Kg) | Dimensions (mm) | Top/Band | Price (SEK) |
|------------------------------------------------------------------------------------|----------------------------------------|-------------|--------------------------------------------------------------------------------------|----------|-------------|
|  | 83022 FourUs® Worx, FourWorx | 28.4 |  | 1 | 17.562 |
| | | | | 2 | 18.228 |
| | | | | 3 | 18.776 |
| | | | | 4 | 19.436 |
| | | | | 5 | 20.071 |
| | | | | 8 | 26.571 |

For tabletop cutout placements go to: [Oceedesign.com/Cutout.pdf](https://oceedesign.com/Cutout.pdf)





Harc Tub



Harc Tub Meeting

Harc Tub

Design Roger Webb Associates

[Content ↗](#)



For data information, certificates and product description please refer to our website www.fourdesign.dk









- Two-tone fabric option
- 5 star base is available on request

| | | Dimensions (cm) | | Band | Price |
|-------------------------------------------------------------------------------------|------------------------------------------------------------------------------------------------|-------------------------------------------------------------------------------------|-------------------------------------------------------------------------------------|---------------------------------|--------------------------------------------------------------------|
|  | HARCTUBLB1 Low Back Lounge Chair Skid Frame |  |  | 1 2 3 4 5 6 7 | 11.186 11.573 12.151 12.922 14.277 15.818 17.366 |
|  | HARCTUBLB2 Low Back Lounge Chair 4-star Polished Aluminium Swivel & Tilt Base |  |  | 1 2 3 4 5 6 7 | 12.151 12.538 13.115 13.887 15.242 16.783 18.331 |
|  | HARCTUBLB3 18 Kg Low Back Lounge Chair Wooden Frame |  |  | 1 2 3 4 5 6 7 | 16.012 16.399 16.977 17.749 19.103 20.645 22.192 |
|  | HARCTUBHB1 High Back Lounge Chair Skid Frame |  |  | 1 2 3 4 5 6 7 | 14.371 14.949 15.723 16.688 18.426 20.547 23.057 |
|  | HARCTUBHB2 High Back Lounge Chair 4-star Polished Aluminium Swivel & tilt Base |  |  | 1 2 3 4 5 6 7 | 15.336 15.914 16.688 17.652 19.391 21.512 24.022 |
|  | HARCTUBHB3 High Back Lounge Chair Wooden Frame |  |  | 1 2 3 4 5 6 7 | 19.198 19.775 20.549 21.514 23.252 25.373 27.883 |

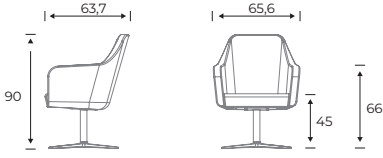

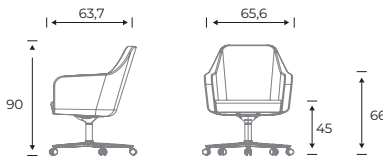

Harc Tub Meeting

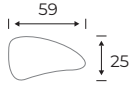
Design Roger Webb Associates

[Content ↗](#)

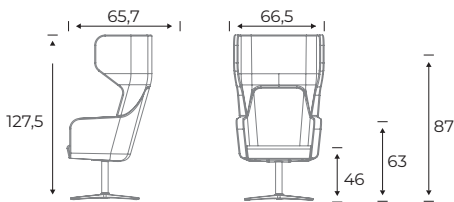
| | | Dimensions (cm) | Band | Price |
|------------------------------------------------------------------------------------|-------------------------------------------------------------------------------------------------------------------------------|-------------------------------------------------------------------------------------|---------------------------------|--------------------------------------------------------------------|
|  | HARCTUBMB2 Low Back Meeting Chair 4-star Polished Aluminium Swivel & Tilt Base |  | 1 2 3 4 5 6 7 | 12.151 12.538 13.115 13.887 15.242 16.783 18.331 |
|  | HARCTUBMB6 Low back meeting chair 5 star polished aluminium base with castors |  | 1 2 3 4 5 6 7 | 11.186 11.573 12.151 12.922 14.277 15.818 17.366 |
|  | HARCTUHR Headrest option for all Harc Low Back Tub Chairs and Meeting Chairs |  | 1 2 3 4 5 6 7 | 2.562 2.688 2.811 2.965 3.273 3.616 4.015 |
|  | TABLET Tablet option for Harc meeting with a 4 star base and Harc meeting with 5 star base and castors* |  | | 4.055 |

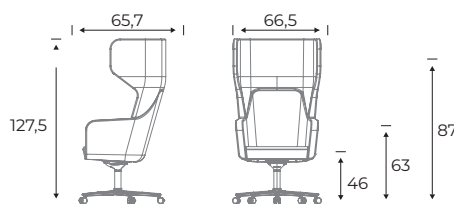
*Tablet not available on 4 and 5 star base with swivel return option

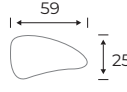
| | | | | |
|-------------------------------------------------------------------------------------|-------------------------------------------------------------------------------------------------|-------------------------------------------------------------------------------------|---------------------------------|--------------------------------------------------------------------|
|  | HARCTUBMH2 High back meeting chair 4-star polished aluminium swivel & tilt base |  | 1 2 3 4 5 6 7 | 15.336 15.914 16.688 17.652 19.391 21.512 24.022 |
|  | HARCTUBMH6 High back meeting chair 5-star polished aluminium base with castors |  | 1 2 3 4 5 6 7 | 14.371 14.949 15.723 16.688 18.426 20.547 23.057 |
|  | TABLET Tablet option for Harc meeting with a 5 star base and castors* |  | | 4.055 |

*Tablet not available on 4 and 5 star base with swivel return option

Specifications & Options

- Low and high back option on all models
- Two-tone fabric option
- Moulded foam for additional comfort and durability
- Headrest option for all Harc Low Back tub chairs and Meeting chairs

Frame options





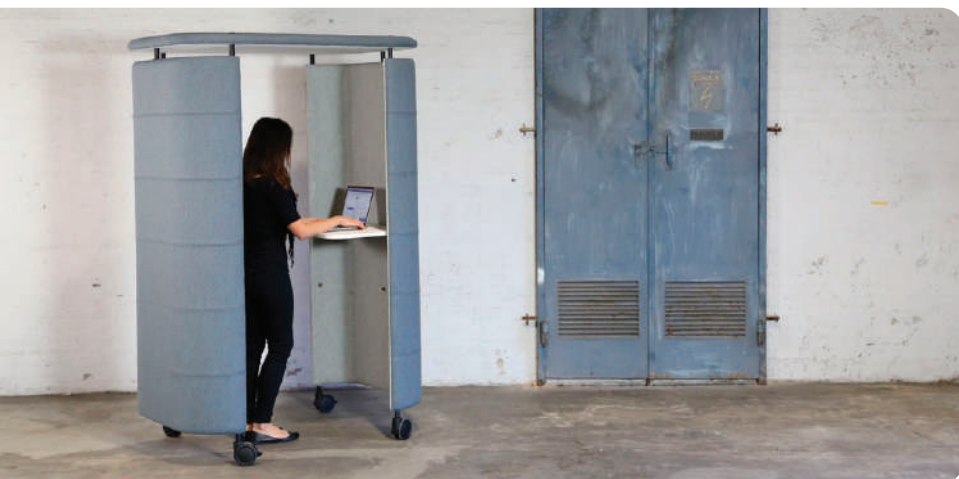

Black, White, Warm Grey, chrome, oak oiled, oak stained black, aluminium (chairs with swivel base only)



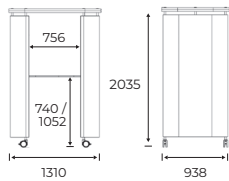

För datainformation, certifikat och produktbeskrivning, se vår webbplats www.oceefour.com

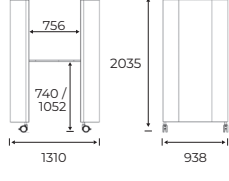

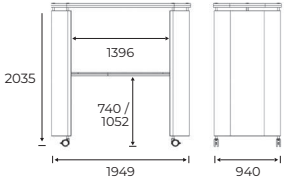
- Tillgänglig i två storlekar
- Två olika bordshöjder

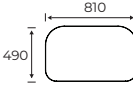
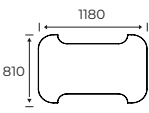
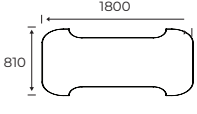
| | | Mått (mm) | Grupp | Pris |
|-------------------------------------------------------------------------------------|------------------------------------------------------------------------|-------------------------------------------------------------------------------------|-------|--------|
|  | 62000 Inno Pod Inkl. bordsskiva 81 x 49 cm 110 kg |  | 1 | 27.037 |
| | | | 2 | 28.584 |
|  | 62001 Inno Pod Inkl. bordsskiva 81 x 118 cm 114 kg |  | 1 | 28.485 |
| | | | 2 | 30.032 |
|  | 62003 Inno Pod Big Inkl. bordsskiva 81 x 180 cm 126 kg |  | 1 | 35.504 |
| | | | 2 | 37.279 |

| Tillbehör | | Mått (mm) | Bordsskiva | Pris |
|-------------------------------------------------------------------------------------|---------------------------------------------------------------------------------------------------------------------------------------------------------------------------------|-------------------------------------------------------------------------------------|------------|-------|
|  | 62100 Bordsskiva (1 stolupphängning kan monteras) |  | 07 ● | 2.593 |
| | | | 08 ● | |
| | | | 09 ● | |
| 62101 Bordsskiva (1 stolupphängning kan monteras) |  | 07 ● | 5.985 | |
| | | 08 ● | | |
| | | 09 ● | | |
| 62103 Bordsskiva (Stolupphängning kan inte monteras) |  | 07 ● | 9.651 | |
| | | 08 ● | | |
| | | 09 ● | | |
|  | CS1 Stolupphängning till FourCast2 Four, FourCast2 Line, FourSure 44, FourSure 88, FourSure 11, FourSure 99, Four Stools, Four Seating Benches 0,288kg | | | 255 |
| | CS2 Stolupphängning till Four Cast Wheeler, Four Sure 66 0,288kg | | | 255 |



Let's furnish the world *better*

When we design a product, we consider every stage of the products lifecycle to ensure we are making responsible choices throughout all areas of the company. Each stage has the possibility to effect the next and so the whole picture is considered. Responsible manufacturing not only looks at the materials and where they are sourced, but also the manufacturing site and resources consumed; the use and durability of the product; the packaging and delivery service; as well as the product's end-of-life.

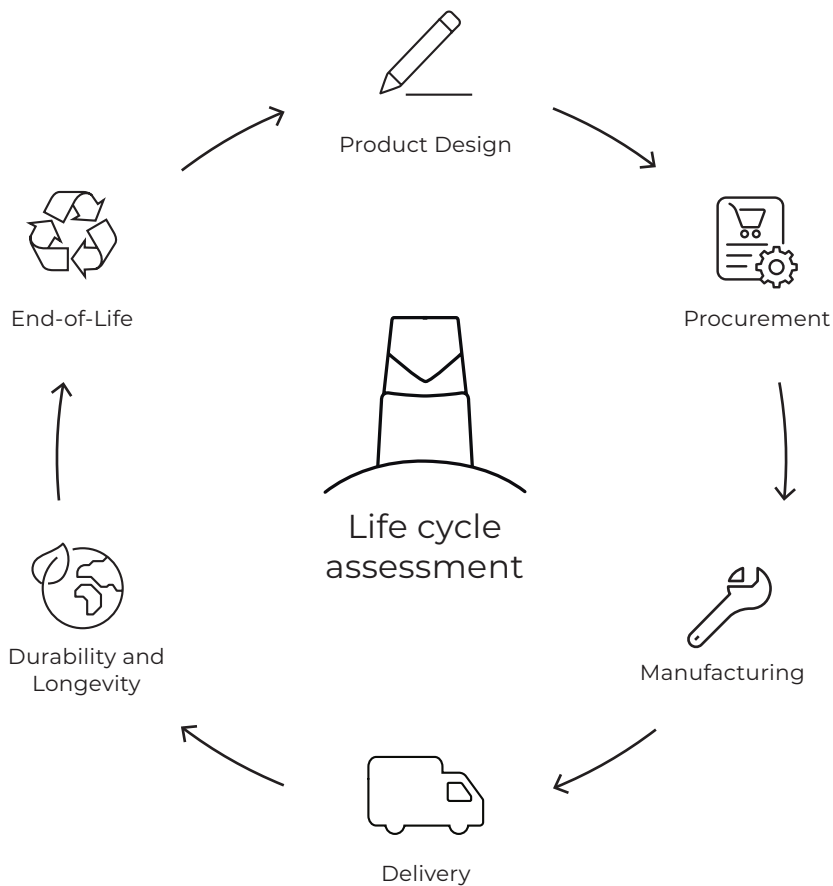

Our furniture are
tested for Globally use





The following images are for illustrative purposes only. The finished product will contain standardised sockets based on the country of your choice. Please note prices include our team supplying products with prepared hole for unit installation. Please note, for tables, the electrical unit will be delivered separately, please follow the assembly instructions provided with your order to install the unit. For soft seating, the electrical unit will be preinstalled.

| EVOLINE | | PRICE (SEK) |
|-------------------------------------------------------------------------------------|------------------------------------------------------------------------------------------------------------------------------------------------------------------------------------------------------------------------------------------------------------------------------------------------------------------------------------------------------------------------------------------------------------|--------------------------------------------------------------------------------------------------------------------------------------------------------------------------------------------------------------------------------------------------------------------------------------------------------------------------|
|  | <p>EVOLINE ONE BLACK (APO00101)</p> <p>Ø60 Socket, 13 A, contactprotected. Power supply module with cable and connector, plug, cable length 3.0 m, black with lock. Power supply module with cable and connector, socket, cable length 3.0 m, black without lock.</p> | <p>FourReal® FourReal® A Four®Learning Four®Eating Four®Meeting Four®Mat FourLikes® T FourLikes® FourLikes® Meet FourLikes® Scooter (1400/2100)</p> <p>FourUs® Work/Booth (tabletop) Harc Sofa/Modular Harc Booth tabletop FourPeople Sofas/Booths/Huts</p> <p>1.865</p> |
|  | <p>EVOLINE ONE WHITE (APO00102)</p> <p>Ø60 Socket, 13 A, contactprotected. Power supply module with cable and connector, plug, cable length 3.0 m, black with lock. Power supply module with cable and connector, socket, cable length 3.0 m, black without lock.</p> | <p>FourReal® FourReal® A Four®Learning Four®Eating Four®Meeting Four®Mat FourLikes® T FourLikes® FourLikes® Meet FourLikes® Scooter (1400/2100)</p> <p>FourUs® Work/Booth (tabletop) Harc Sofa/Modular Harc Booth tabletop FourPeople Sofas/Booths/Huts</p> <p>1.865</p> |
|  | <p>EVOLINE ONE USB BLACK (APO00201)</p> <p>USB socket, charging function only. Rated output current: 2100 mA; Type A + C. Power supply module with cable and connector, plug, cable length 3.0 m, black with lock. Power supply module with cable and connector, socket, cable length 3.0 m, black without lock.</p> | <p>FourReal® FourReal® A Four®Learning Four®Eating Four®Meeting Four®Mat FourLikes® T FourLikes® FourLikes® Meet FourLikes® Scooter (1400/2100)</p> <p>FourUs® Work/Booth (tabletop) Harc Sofa/Modular Harc Booth tabletop FourPeople Sofas/Booths/Huts</p> <p>2.566</p> |
|  | <p>EVOLINE ONE USB WHITE (APO00202)</p> <p>USB socket, charging function only. Rated output current: 2100 mA; Type A + C. Power supply module with cable and connector, plug, cable length 3.0 m, black with lock. Power supply module with cable and connector, socket, cable length 3.0 m, black without lock.</p> | <p>FourReal® FourReal® A Four®Learning Four®Eating Four®Meeting Four®Mat FourLikes® T FourLikes® FourLikes® Meet FourLikes® Scooter (1400/2100)</p> <p>FourUs® Work/Booth (tabletop) Harc Sofa/Modular Harc Booth tabletop FourPeople Sofas/Booths/Huts</p> <p>2.566</p> |
|  | <p>EVOLINE FRAMEDOCK BLACK (APF3010102)</p> <p>2 x Socket Modules, 13 A, contactprotected. 1 x Socket Modules, USB socket, charging function only. Rated output current: 2100 mA; Type A + C. Power supply module with cable and connector, plug, cable length 3.0 m, black with lock. Power supply module with cable and connector, socket, cable length 3.0 m, black with lock.</p> | <p>FourReal® FourReal® A Four®Learning Four®Eating Four®Meeting Four®Mat</p> <p>3.370</p> |
|  | <p>EVOLINE FRAMEDOCK SILVER ANODISED (APF3030102)</p> <p>2 x Socket Modules, 13 A, contactprotected. 1 x Socket Modules, USB socket, charging function only. Rated output current: 2100 mA; Type A + C. Power supply module with cable and connector, plug, cable length 3.0 m, black with lock. Power supply module with cable and connector, socket, cable length 3.0 m, black with lock.</p> | <p>FourReal® FourReal® A Four®Learning Four®Eating Four®Meeting Four®Mat</p> <p>3.370</p> |

EVOLINE

PRICE (SEK)



EVOLINE DOCKFIX BLACK (APD3010102)

2 x Socket Modules, 13 A, contactprotected. 1 x Socket Modules, USB socket, charging function only. Rated output current: 2100 mA; Type A + C.
Power supply module with cable and connector, plug, cable length 3.0 m, black with lock.
Power supply module with cable and connector, socket, cable length 3.0 m, black with lock.
With sidebrackets for sub-mounting.

FourUs®
FourUs® Booth
FourUs® Work Booth
FourUs® Solo
FourUs® 3 Seater
FourUs® Corner

3,668



CHAIRS

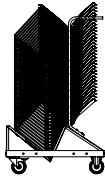

CHAIR TROLLEY - 200X0

Chair trolley for:

FourSure® 44
 FourSure® 44 Armrest
 FourSure® 88
 FourSure® 88 Armrest
 FourCast® 2 Four
 FourCast® 2 Four Armrest
 FourCast® 2 Line
 FourCast® 2 Line Armrest

200A0
 200C0
 200F0
 200I0

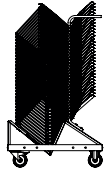

CHAIR TROLLEY - 200X0

Chair trolley for:

FourCast® 2 Four Seat/Fully
 FourCast® 2 Four Seat/Fully Arm
 FourCast® 2 Line Seat/Fully
 FourCast® 2 Line Seat/Fully Arm
 FourCast® 2 Line Veneer
 FourSure® 44 Inside/Seat/Fully
 FourSure® 44 Seat/Arm
 FourSure® 44 Inside/Arm
 FourSure® 88 Seat
 FourSure® 88 Inside
 FourSure® 88 Seat/Inside Arm
 Share Basic without / seat upholstery

20020
 20030
 20060
 20090
 20070
 200B0
 200E0
 200D0
 200G0
 200H0
 200J0
 20060



SACK TROLLEY - 200X1

Chair trolley for:

FourCast® 2 Four
 FourCast® 2 Line
 FourSure® 44
 FourSure® 88

20011
 20051
 200A1
 200F1

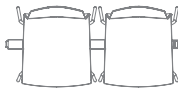

LINKING DEVICE

Chair linking under seat

FourCast® 2 Four/Seat
 FourCast® 2 Line/Seat
 FourSure® 44
 FourSure® 88
 FourCast® 2 Four/Fully
 FourCast® 2 Line/Fully
 FourSure® 44 Seat/Inside
 FourSure® 88 Seat/Inside



LINKING DEVICE

Chair linking on frame

FourCast® 2 Line
 FourSure® 88

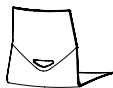

GRIP HOLE

Grip hole is available for chairs without inside – and full upholstery.

GRIP

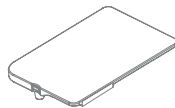

INNO

Inno® Note – A slim writing tablet matches a 13" laptop and has integrated cupholder. 225 x 325 x 10 mm (1,4 kg)

FourCast® 2 Four
 FourCast® 2 Line
 FourSure® 44
 FourSure® 88

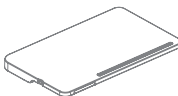

INNO

Inno® Tab - Writing tablet with integrated with integrated cup holder and dashboard for tablet and phone. 520 x 320 x 23 mm (2,7 kg)

FourCast® 2 Wheeler
 FourSure® 66
 FourMe® 66
 FourCast® 2 Audi
 FourSure® Audi

CHAIRS

| | | | |
|--|---------------------------------------------------------------------------------------------------------------------------------------|----------------------------------------------------------------------------------------------------------------------------------------------------------------------------------------------------------------------------------------------------------------------------------------------------------------------------------------------------------------------------------------------------------------|----------------------------------------|
| | <p>INNO®NOTE TROLLEY - 20100007 Trolley for Inno®Note. Room for 51 Inno®Notes</p> | <p>FourCast® 2 Four FourCast® 2 Line FourSure® 44 FourSure® 88</p> | <p>20100007</p> |
| | <p>INNO Inno® Tab B – Writing tablet and powder coated frame with integral cup holder and coat hook. 585 x 308 mm.</p> | <p>White Antchracite</p> | |
| | <p>INNO Inno® Tab C – Writing tablet and powder coated frame with integral cup holder and coat hook. 475 x 278 mm.</p> | <p>White Antchracite</p> | |
| | <p>HOOK</p> | <p>FourCast2® Wheeler FourSure® 66</p> | |
| | <p>GASFOOT Incl. foot ring</p> | <p>FourCast® 2 Wheeler FourSure® 66 FourMe® 66</p> | <p>GASFOOT GASFOOT GASFOOT</p> |
| | <p>WHEELS</p> | <p>FourCast® 2 Evo FourCast® 2 XL/XL Plus FourSure® 99 FourMe® 99</p> | |
| | <p>STANDARD POLYIMIDE GLIDES Chair height + 0,2 cm</p> | <p>FourCast® 2 Wheeler FourSure® 66 FourMe® 66</p> | |
| | <p>TEFLON GLIDERS Set of 4 pcs. Chair height + 0,2 cm</p> | <p>FourCast® 2 Four / Eco FourCast® 2 Line / Eco FourCast® 2 Counter/High / Eco FourCast® 2 Counter/High Four / Eco FourCast® 2 One FourSure® 44 / Eco FourSure® 88 / Eco FourSure® 90/105/Eco FourSure® 11 + FourSure® 99 FourMe® 44 + FourMe® 88 FourMe® 11 + FourMe® 99 Four® Stools Four® Seating Benches</p> | |
| | <p>FELT GLIDES Set of 4 pcs. Chair height + 0,2 cm</p> | <p>FourCast® 2 Four / Eco FourCast® 2 Line / Eco FourCast® 2 Counter/High / Eco FourCast® 2 Counter/High Four / Eco FourCast® 2 One FourCast® 2 Evo FourCast® 2 XL/Plus FourCast® 2 Lounge FourSure® 44 / Eco FourSure® 88 / Eco FourSure® 90/105 / Eco FourSure® 11 + FourSure® 99 FourMe® 44 + FourMe® 88 FourMe® 11 + FourMe® 99 FourMe® Lounge</p> | |
| | <p>FELT GLIDES FOR WOODEN LEGS Set of 4 pcs. Chair height + 0,2 cm.</p> | <p>FourCast® 2 Four FourSure® 44 FourMe® 44</p> | |

CHAIRS

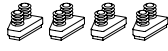

**FELT GLIDES
STOOLS & BENCHES
WOODEN LEGS**
4-pack. Sitthöjd + 0,2 cm

Four® Stools wooden legs
Four® Seating Benches wooden legs



FEET/GLIDERS/CASTORS
Noise reducing ferrule with felt.
Set of 4 pcs. Chair height + 1 cm

FourCast® 2 Four
FourCast® 2 One
FourSure® 44
FourSure® 11
FourMe® 44
FourMe® 11

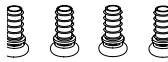

FEET/GLIDERS/CASTORS
Noise reducing ferrule with big
diameter (reduces pressure marks).
Set of 4 pcs. Chair height + 0,8 cm

FourCast® 2 Four
FourCast® 2 One
FourSure® 44
FourSure® 11
FourMe® 44
FourMe® 11



**CHAIR SEAT-ROW -
ACSR0201**
11 mm - no. 1 - 25

FourCast® 2 Line
Eco Label FourCast® 2 Line
Fire Retardent FourCast® 2 Line
FourSure® 88
Eco Label FourSure® 88

ACSR0201



**CHAIR SEAT-ROW -
ACSR0202**
11 mm - no. 26 - 50

FourCast® 2 Line
Eco Label FourCast® 2 Line
Fire Retardent FourCast® 2 Line
FourSure® 88
Eco Label FourSure® 88

ACSR0202



**CHAIR SEAT-ROW -
ACSR0101**
16 mm - no. 1 - 25

FourCast® 2 Four
Eco Label FourCast® 2 Four
Fire Retardent FourCast® 2 Four
FourSure® 44
Eco Label FourSure® 44

ACSR0101















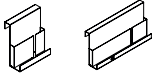

**CHAIR SEAT-ROW -
ACSR0102**
16 mm - no. 26 - 50

FourCast® 2 Four
Eco Label FourCast® 2 Four
Fire Retardent FourCast® 2 Four
FourSure® 44
Eco Label FourSure® 44

ACSR0102

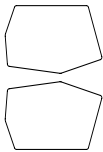
| TABLES | | | |
|--------------------------------------------------------|-------------------------------------------------------------------------------------------------------------------------------------------------------------------------------|--------------------------------------------------------------------------------------------------------------------------------------|----------------------------------------------------------------------------------|
| | <p>TABLE TROLLEY - 20100001 Trolley for 10 folded tables or 7 round tables, including strap. 20 Kg. L: 172 x W: 55 x H: 98 cm Folded Table: 15 cm</p> | <p>Four® Learning Four® Eating FourReal® 74 FourReal® 90 FourReal® 105 FourReal® 741 Flake</p> | <p>20100001 20100001 20100001 20100001 20100001 20100001</p> |
| | <p>CHAIR SUSPENSION Chair suspension for FourCast2 Four, FourCast2 Line, FourSure 44, FourSure 88, FourSure 11, FourSure 99, Four Stools, Four Seating Benches</p> | <p>Four® Learning Four® Eating Four® Meeting FourReal® 74 FourReal® 90 FourReal® 105 FourReal® 741 Flake</p> | <p>CS1</p> |
| | <p>CHAIR SUSPENSION Chair suspension for FourCast2 Wheeler, FourSure 66</p> | <p>Four® Learning Four® Eating Four® Meeting FourReal® 74 FourReal® 90 FourReal® 105 FourReal® 741 Flake</p> | <p>CS2</p> |
| | <p>CABLE CUT OUT Cable duct, aluminum. Cable duct placed in apron</p> | <p>Four® Learning Four® Eating Four® Meeting FourReal®</p> | <p>CD</p> |
| | <p>CD Cable duct, single, incl., hole in table top. Aluminium.</p> | <p>Four® Mat</p> | <p>CD1</p> |
| | <p>CD Cable duct, double, incl., hole in table top. Aluminium.</p> | <p>Four® Mat</p> | <p>CD2</p> |
| | <p>FRLINK Linking Device, set of 4 pcs - 2 x he, 2 x she per table</p> | <p>Four® Learning Four® Eating Four® Meeting FourReal®</p> | |
| | <p>CASTORS Castors height adjustable wheel in black with brakes. Set of 4 pieces</p> | <p>FourFold®</p> | <p>CF</p> |
| | <p>CASTORS</p> | <p>Four® Resting</p> | |
| | <p>HOLE Pre-drilled hole for power</p> | <p>All tables</p> | |
| <p>60 cm x 13 cm x 15 cm 80 cm x 13 cm x 15 cm</p> | <p>FLOWER BOX FourReal A 74 + 90 FourReal A.XL 74 + 90 FourReal AV</p> | <p>Black 600 mm Black 800 mm</p> | <p>699000008 699000005</p> |
| | <p>TOP-SHELF FourReal A 74 + 90 FourReal A.XL 74 + 90 FourReal AV</p> | <p>White 600 mm x 205 mm Black 600 mm x 205 mm Grey 600 mm x 205 mm</p> | <p>699000001 699000002 699000003</p> |

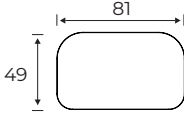
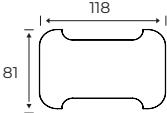
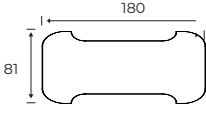
| SOFT SEATING | | | |
|-------------------------------------------------------------------------------------|---------------------------------------------------------------------------------------------------------|---------------------------------------------------------------------------------------------------------|--------------------------------|
|  | LINKING DEVICE 2 her x 2 him | FourLikes® | |
|  | LINKING DEVICE Linking Device | FourLikes® Scooter | |
| | FEET Feet for FourLikes Scooter | FourLikes® Scooter | |
|  | WHEELS | FourLikes® Scooter | |
|  | INNO® TAB LEFT Black Fenix-Laminate <i>*Only with standard legs</i> L: 480 x W: 300 mm | FourUs® FourUs® 3-seater FourUs® Booth 2 FourUs® Booth | 16082-1A1-92 |
|  | INNO® TAB RIGHT Black Fenix-Laminate <i>*Only with standard legs</i> L: 480 x W: 300 mm | FourUs® FourUs® 3-seater FourUs® Booth 2 FourUs® Booth | 16072-1A1-92 |
|  | SHELF Black Fenix-Laminate L: 1500 x W: 300 mm Heigh from floor: 905 mm | FourUs® FourUs® Booth FourUs® Work Booth | 8990J-101-13 |
|  | CASTORS | FourUs® FourUs® Solo | 8990K-100-00 |
|  | SKID FRAME | FourUs® FourUs® 3-seater FourUs® Booth 2 FourUs® Booth FourUs® Corner FourUs® Solo | 8990M-500-00 |
|  | MAGAZINE HOLDER W: 300 mm / 700 mm | FourUs® FourUs® 3-seater FourUs® Booth 2 FourUs® Booth FourUs® Corner FourUs® Work Booth | 8990T-000-99 / 8990T-001-99 |
|  | MAGAZINE HOLDER, BLACK B: 225 x D: 95 x H: 970 mm | FourUs® Booth FourUs® Booth 2 FourUs® Work Booth | 8990T-B00-99 |
| | MAGAZINE HOLDER, WHITE B: 225 x D: 95 x H: 970 mm | | 8990T-C00-99 |
| | MAGAZINE HOLDER, GREY B: 225 x D: 95 x H: 970 mm | | 8990T-K00-99 |
|  | PIVOT TABLE Black Fenix-laminate | FourUs® Booth 2 FourUs® Booth | 85045 |

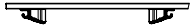
| SOFT SEATING | | | | | |
|-------------------------------------------------------------------------------------|-------------------------------------------------------------------------------------------------------------------------------------------------------------------|--------------------------------------------------------|----------------------|--|--------------|
|  | PIVOT TABLE, RIGHT L: 1380 x B: 750 x H: 720 mm | FourUs® Work Booth | | | 870GS-106 |
| | PIVOT TABLE, LEFT L: 1380 x B: 750 x H: 720 mm | | | | 870GS-107 |
|  | TV BRACKET Option hidden cable | FourUs® Booth 2 FourUs® Booth FourUs® Work Booth | | | 8100T-100-00 |
| | CABLE MANAGEMENT TV Pre-drilled hole in wall for cables | FourUs® Booth 2 FourUs® Booth FourUs® Work Booth | | | |
| | CABLE MANAGEMENT STANDARD Fabric with velcro for concealing cable underneath the table | FourUs® Booth 2 FourUs® Booth FourUs® Work Booth | | | |
| ACOUSTIC | | | | | |
|  | TABLE TOP (1 pcs. chair suspension) Colours: 08 Warm grey, 38 Antracit, 10 Black | InnoPod® | 08 ● 38 ● 10 ● | | 62100 |
|  | TABLE TOP (1 pcs. chair suspension) Colours: 08 Warm grey, 38 Antracit, 10 Black | InnoPod® | 08 ● 38 ● 10 ● | | 62101 |
|  | TABLE TOP (No chair suspension) Colours: 08 Warm grey, 38 Antracit, 10 Black | InnoPod® | 08 ● 38 ● 10 ● | | 62103 |
|  | CS1 Chair suspension for FourCast2 Four, FourCast2 Line, FourSure 44, FourSure 88, FourSure 11, FourSure 99, Four Stools, Four Seating Benches | InnoPod® | | | 23099-002-99 |
|  | CS2 Chair suspension for FourCast2 Wheeler, FourSure 66 | InnoPod® | | | 23099-003-99 |

Chair shell colours





| | | | |
|----------------------------------------------------------------------------------------------------------------------------|-----------------------------------------------------------------------------------------------------------------------------------|---------------------------------------------------------------------------------------------------------------------------|-------------------------------------------------------------------------------------------------------------------------------|
|  01 / SNOW RAL 9010 |  14 / WHITE Fire Retardant RAL 9010 |  02 / EBONY BLACK NCS S 9000-N |  03 / ANTHRACITE RAL 7015 |
|  05 / AQUA NCS S 4020-B |  17 / PINE NCS S 5005-B80G |  18 / MOSS NCS S 5010-G70Y |  12 / TERRACOTTA NCS S 4510-Y60R |
|  13 / CLAY NCS S 6005-Y20R |  10 / BEACH NCS S 2502-Y |  09 / OLIVE NCS S 2040-G80Y |  08 / ORANGE NCS S 2070-Y70R |
|  07 / ORIENTAL RED NCS S 1580-R |  06 / JUNGLE GREEN NCS 4050-G40Y |  31 (03) / OAK |  32 (04) / OAK BLACK |

Chair frame colours

| | | | |
|-----------------------------------------------------------------------------------------------------------------------------------|----------------------------------------------------------------------------------------------------------------------------------------|--------------------------------------------------------------------------------------------------------------------------------------|------------------------------------------------------------------------------------------------------------------------------|
|  C (02) / MATT WHITE RAL 9010 |  B (01) / MATT BLACK RAL 7021 |  K (03) / STONE GREY RAL 7039 |  9 / BLACK |
|  E / ANTHRACITE RAL 7024 gl.5 |  M / AQUA S4020-B IGP 581 TA 52240 A 00 |  D / PINE IGP 591 TA 79407 R10 |  F / MOSS IGP 591 TA 64445 R10 |
|  7 / TERRACOTTA IGP 591 TA 83991 R10 |  A / CLAY IGP 591 TA 79406 R10 |  T / BEACH IGP 681 TA 77644 A 00 |  S / OLIVE RAL 7042 gl. 5 |
|  N / ORANGE IGP 681 TA 21349 A 00 |  Q / ORIENTAL RED IGP 581 TA 33080 A 00 |  O / JUNGLE GREEN IGP 681 TA 64014 A 00 | |
|  4 / ALUMINIUM |  5 / MAT CHROME |  6 / CHROME | |
|  P / OAK BLACK OILED |  V / OAK LACQUERED BLACK |  L / OAK OILED |  U / OAK CLEAR MATT LACQUERED |

Share colours



SHARE SEAT/BACK COLOURS

| | |
|-----------------------------------------------------------------------------------------------------------------------------|---------------------------------------------------------------------------------------------------------------------------|
|  19 / DENIM NCS S 6020-B10G |  20 / CLARET NCS S 7010-R10B |
|  02 / EBONY BLACK NCS S 9000-N |  13 / CLAY NCS S 6005-Y20R |
| |  10 / BEACH NCS S 2502-Y |

SHARE BACK COVER COLOURS



| | | | |
|-----------------------------------------------------------------------------------------------------------------------------|---------------------------------------------------------------------------------------------------------------------------|-------------------------------------------------------------------------------------------------------------------------|---------------------------------------------------------------------------------------------------------------------------|
|  19 / DENIM NCS S 6020-B10G |  20 / CLARET NCS S 7010-R10B |  21 / TEAL NCS S 5030-B10G |  22 / ROSE NCS S 2040-R20B |
|  02 / EBONY BLACK NCS S 9000-N |  13 / CLAY NCS S 6005-Y20R |  10 / BEACH NCS S 2502-Y | |

Tabletops



| | | |
|------------------------------------------------------------------------------------------------------------------------------|------------------------------------------------------------------------------------------------------------------------------|--------------------------------------------------------------------------------------------------------------------------|
|  01 / WHITE W980 LAMINATE |  02 / LIGHT GREY EGGER U763 LAMINATE |  03 / GREY EGGER U732 LAMINATE |
|  04 / WHITE W980 DECOR |  05 / LIGHT GREY EGGER U763 DECOR |  06 / GREY EGGER U732 DECOR |
|  07 / WARM GREY ARPA FENIX NANO 0718 |  08 / ANTRACIT ARPA FENIX NANO 0724 |  09 / BLACK ARPA FENIX NANO 0720 |
|  10 / BLACK 4023 LINOLEUM |  20 / WHITE COMPACT LAMINATE F2255 | |

FOUR MAT TABLE

| |
|------------------------------------------------------------------------------------------------------------|
|  71 / MAPLE VENEER |
|  70 / BEECH VENEER |

| |
|-------------------------------------------------------------------------------------------------------------|
|  72 / WALNUT VENEER |
|  79 / OAK VENEER |

HARC TUB TABLE

| |
|--------------------------------------------------------------------------------------------------------------|
|  68 / BLACK LAMINATE |
|  43 / OAK LAMINATE |





OUTDOOR TABLETOPS

| | |
|------------------------------------------------------------------------------------------------------------------------------|-----------------------------------------------------------------------------------------------------------------------------------|
|  20 / WHITE COMPACT LAMINATE F2255 |  57 / LIGHT GREY COMPACT LAMINATE F7927 |
|------------------------------------------------------------------------------------------------------------------------------|-----------------------------------------------------------------------------------------------------------------------------------|

Table frames

| | | |
|-------------------------------------------------------------------------------------------------------------------------|-------------------------------------------------------------------------------------------------------------------------|--------------------------------------------------------------------------------------------------------------------|
|  C / MATT WHITE RAL 9010 |  B / MATT BLACK RAL 7021 |  K / STONE GREY RAL 7039 |
|  E / ANTHRACITE RAL 7024 gl.5 |  6 / CHROME |  4 / ALUMINIUM |
|  V / OAK LACQUERED BLACK |  U / OAK CLEAR MATT LACQUERED | |

OUTDOOR FRAMES

| | | | |
|-------------------------------------------------------------------------------------------------------------|------------------------------------------------------------------------------------------------------------|-------------------------------------------------------------------------------------------------------------|--------------------------------------------------------------------------------------------------------------|
|  H / WHITE SMOOTH |  J / WHITE ROUGH |  G / BLACK SMOOTH |  I / BLACK ROUGH |
|-------------------------------------------------------------------------------------------------------------|------------------------------------------------------------------------------------------------------------|-------------------------------------------------------------------------------------------------------------|--------------------------------------------------------------------------------------------------------------|

This is just a selection of the cover options available. We are able to source alternative fabrics. Please contact info@fourdesign.dk for details.

Disclaimer – This fabric can be used on the listed products, but we believe that a better finish can be achieved from other fabric selections.

Shade – Only certain shades of the fabric are appropriate for use on these products. Please contact us for details.

Sample – Our upholstery experts will sample the suitability of this material range upon request.

FABRIC SUPPLIERS:

www.camirafabrics.com, www.gabriel.dk, www.kvadrat.dk

InnoPod®

Band 1

Go Check, Main Line Flax, Main Line Plus, Patina, Step Melange

Band 2

Crisp, Europost2, Fame, Select, Chili, Nejma, Passion

Fabricks™

Band 3

Blazer Lite, *Blazer

























































































Tessellate





Band 1: Tempt

Band 3: Blazer Lite

Band 5: Canvas

| | Sustainability factor | Soft Seating/ RoomInRoom | Harc Tub High Back/FourLikes Meet 1400+700 | Fully Upholstered FourCast/FourSure | FourMe | Seat & Inner Upholstered FourCast/FourSure |
|-------------------|-----------------------|--------------------------|--------------------------------------------|-------------------------------------|------------|--------------------------------------------|
| Band 1 | | | | | | |
| Aspect | Camira ♥ ♻️ ↓ | Yes | Yes | Yes | Yes | Yes |
| Advantage | Camira ♥ ♻️ ↓ | Yes | Yes | Yes | Yes | Yes |
| Atlas | Kvadrat ♥ ♻️ ↓ | Yes | Shade | Shade | Shade | Shade |
| Canopy | Camira ♥ ♻️ ↓ | Yes | FLM 700+1400 only | Yes | Yes | Yes |
| Clara 2 | Kvadrat ♥ ♻️ ↓ | Yes | Shade | Yes | Yes | Yes |
| Connect | Gabriel ♥ ♻️ ♻️ ↓ | Yes | Yes | Yes | Yes | Sample |
| Cura | Gabriel ♥ ♻️ ♻️ ↓ | Yes | SHADE | Yes | Yes | Yes |
| Era | Camira ♥ ♻️ ↓ | Yes | Yes | Yes | Yes | Yes |
| Event | Gabriel ♥ ♻️ ↓ | No | No | Yes | Yes | Sample |
| Felicity | Gabriel ♥ ♻️ ♻️ ↓ | Yes | SHADE | Yes | Yes | No |
| Field 2 | Kvadrat ♥ ♻️ ♻️ ↓ | Disclaimer | No | Disclaimer | Disclaimer | Yes |
| Go Check | Gabriel ♥ ♻️ ↓ | Yes | SHADE | Yes | Yes | Yes |
| Go Couture | Gabriel ♥ ♻️ ↓ | Yes | SHADE | Yes | Yes | Yes |
| Go Uni | Gabriel ♥ ♻️ ↓ | Yes | SHADE | Yes | Yes | No |
| Gravity | Camira ♥ ♻️ ↓ | No | No | Disclaimer | Disclaimer | Disclaimer |
| Halcyon Aspen | Camira ♥ ↓ | Yes | No | Yes | No | No |
| Halcyon Blossom | Camira ♥ ↓ | Yes | No | Yes | No | No |
| Halcyon Cedar | Camira ♥ ↓ | Yes | No | Yes | No | No |
| Main Line Plus | Camira ♥ ↓ | Yes | Yes | Yes | Yes | Yes |
| Main Line Flax | Camira ♥ ♻️ ↓ | Yes | Yes | Yes | Yes | Yes |
| Manila | Camira ♥ ↓ | Yes | No | Yes | No | No |
| Manhattan | Camira ♥ ♻️ ♻️ ↓ | Yes | No | Yes | Yes | No |
| Patina | Camira ♥ ♻️ ↓ | Yes | Yes | Yes | Yes | Yes |
| Phoenix | Camira ♥ ♻️ ↓ | No | No | Disclaimer | Disclaimer | Disclaimer |
| Quest | Camira ♥ ♻️ ♻️ ↓ | Yes | Yes | Yes | Yes | Yes |
| Repetto | Gabriel ♥ ♻️ ♻️ ↓ | Yes | SHADE | Yes | Yes | No |
| Rivet | Camira ♥ ♻️ ♻️ ↓ | No | No | Disclaimer | Disclaimer | Disclaimer |
| Step | Gabriel ♥ ♻️ ↓ | Yes | Yes | Yes | Yes | Yes |
| Step Melange | Gabriel ♥ ♻️ ↓ | Yes | Yes | Yes | Yes | Yes |
| Tempt | Gabriel ♥ ♻️ ↓ | Yes | shade | Yes | Yes | No |
| Tonal | Gabriel ♥ ♻️ ♻️ ↓ | Sample | Sample | Yes | Yes | Sample |
| Urban | Camira ♥ ♻️ ♻️ ↓ | No | No | No | No | No |
| Vita Vinyl | Camira ♥ ↓ | Yes | Sample | Yes | No | Yes |
| Valencia | Spradling ♥ ↓ | Yes | Harc Tub only | Yes | No | Yes |
| Xtreme | Camira ♥ ♻️ ♻️ ↓ | Yes | Yes | Yes | Yes | Yes |
| Band 2 | | | | | | |
| Aquarius | Camira ♥ ♻️ ↓ | Yes | Yes | Yes | Yes | No |
| Blazer* | Camira ♥ ♻️ ↓ | Yes | Yes | Yes | Yes | Yes |
| Chili | Gabriel ♥ ♻️ ♻️ ↓ | Yes | Yes | Yes | Yes | Yes |
| Contour | Gabriel ♥ ♻️ ↓ | Sample | Sample | Sample | Sample | No |
| Crisp | Gabriel ♥ ♻️ ↓ | Yes | Yes | Yes | Yes | Yes |
| Deca | Camira ♥ ↓ | Yes | No | Sample | No | No |
| Europost 2 | Gabriel ♥ ♻️ ♻️ ↓ | Yes | No | Yes | Yes | Yes |
| Fame | Gabriel ♥ ♻️ ↓ | Yes | Yes | Yes | Yes | Yes |
| Fame Hybrid | Gabriel ♥ ♻️ ↓ | Yes | Yes | Yes | Yes | Yes |
| Harmony | Gabriel ♥ ♻️ ↓ | Yes | Yes | Yes | Yes | Yes |
| Hi-Tech | Camira ♥ ↓ | No | No | Sample | Sample | Sample |
| Honeycomb | Camira ♥ ♻️ ♻️ ↓ | Yes | No | No | No | No |
| Hemp | Camira ♥ ♻️ ♻️ ↓ | Yes | Yes | Yes | Yes | No |
| Intervene Plain | Camira ♥ ♻️ ♻️ ↓ | Yes | No | Yes | No | No |
| Intervene Texture | Camira ♥ ♻️ ♻️ ↓ | Yes | No | Yes | No | No |
| Just | Gabriel ♥ ♻️ ♻️ ↓ | Sample | Sample | Yes | Yes | Sample |
| Kyoto | Camira ♥ ♻️ ↓ | Square units | No | No | No | No |
| Landscape Balance | Camira ♥ ↓ | Yes | Sample | Yes | Yes | No |
| Landscape Contact | Camira ♥ ↓ | Yes | Sample | Yes | Yes | No |
| Medley | Gabriel ♥ ↓ | Yes | Yes | Yes | Yes | Yes |
| Noma | Gabriel ♥ ♻️ ↓ | Yes | Yes | Yes | Yes | Yes |
| Oxygen (MOQ) | Camira ♥ ♻️ ↓ | Yes | Yes | Yes | Yes | No |
| Oceanic | Camira ♥ ♻️ ♻️ ↓ | Yes | Sample | Yes | Yes | Sample |
| Passion | Gabriel ♥ ♻️ ↓ | Yes | Yes | Yes | Yes | Yes |
| Regent (MOQ) | Camira ♥ ↓ | Yes | No | No | No | No |

| | Sustainability factor | Soft Seating/ RoomInRoom | Harc Tub High Back/FourLikes Meet 1400+700 | Fully Upholstered FourCast/FourSure | FourMe | Seat & Inner Upholstered FourCast/FourSure |
|----------------------|-----------------------------------------------------------------------------------------------------------------------------------------------------------------------------------------------------------------------------------------------------------------------|-----------------------------|--------------------------------------------------|----------------------------------------|--------|--------------------------------------------------|
| Band 2 (cont) | | | | | | |
| Remix | Kvadrat   | Yes | Yes | Yes | Yes | Yes |
| Rhythm | Gabriel  | No | No | No | No | No |
| Runner | Gabriel   ↓ | No | No | No | No | Yes |
| Select | Gabriel   | Yes | Yes | Yes | Yes | Yes |
| Savoy | Gabriel   ↓ | Yes | No | No | No | No |
| Silk | Camira    ↓ | Yes | Yes | Yes | Yes | Yes |
| Sumi | Camira   | Yes | Yes | Yes | Yes | Yes |
| Synergy | Camira    | Yes | Yes | Yes | Yes | Yes |
| Track | Camira   ↓ | Yes | No | No | No | No |
| X2 | Camira    ↓ | Yes | Yes | Yes | Yes | Yes |
| Yoredale | Camira  | Yes | Yes | Yes | Yes | Yes |
| 24/7 + | Camira | Sample | Sample | Yes | Yes | Sample |
| 24/7 Flax | Camira   | Yes | Yes | Yes | Yes | Yes |
| Band 3 | | | | | | |
| Armadillo | Camira   | Yes | Yes | Yes | Yes | No |
| Atlantic | Gabriel   | Yes | Shade | Yes | Yes | Yes |
| Bond | Gabriel    ↓ | Yes | Yes | Yes | Yes | Sample |
| Breeze & Breeze Fus. | Gabriel   | Yes | Yes | Yes | Yes | Yes |
| Hebden (MOQ) | Camira    | Yes | Yes | Yes | Yes | No |
| Illusion | Nevotex  | Yes | Sample | Yes | Yes | Yes |
| Individuo | Camira   | Yes | Yes | Yes | Yes | No |
| Mainline Flax Stripe | Camira    | Yes | Sample | Yes | Yes | No |
| Gaja Classic | Gabriel   | Yes | Yes | Yes | Yes | Yes |
| Rondo | Gabriel    ↓ | Yes | Shade | Yes | Yes | Sample |
| Melange Nap | Kvadrat   | Yes | Shade | Yes | Yes | Shade |
| Re-wool | Kvadrat    ↓ | Yes | Yes | Yes | Yes | Yes |
| Zap | Camira   | Yes | Yes | Yes | Yes | No |
| Band 4 | | | | | | |
| Capture | Gabriel   | Yes | Yes | Yes | Yes | Yes |
| Craggan Flax | Camira   | Yes | Harc Tub only | Yes | Yes | No |
| Divina Melange 2 | Kvadrat    | Yes | Yes | Yes | Yes | Yes |
| Mood | Gabriel   | Yes | Harc Tub only | Sample | Sample | Sample |
| Nettle- Aztec | Camira   | Yes | Harc Tub only | Yes | Yes | No |
| Silvertex | Camira | Yes | Yes | Yes | Yes | Yes |
| Band 5 | | | | | | |
| Canvas 2 | Kvadrat   | Yes | Shade | Shade | Shade | Shade |
| Criss Cross | Gabriel   | Yes | Sample | Yes | Yes | No |
| Fiord | Kvadrat   | Yes | Yes | Yes | Yes | Yes |
| Morph | Gabriel   | Sample | Sample | Sample | Sample | Sample |
| Revive 1 | Kvadrat    ↓ | Yes | Yes | Yes | Yes | Yes |
| Steelcut 2 | Kvadrat   | Yes | Yes | Yes | Yes | Yes |
| Steelcut Trio 3 | Kvadrat   | Yes | Yes | Yes | Yes | Yes |
| Band 6 | | | | | | |
| Hallingdal 65 | Kvadrat   | Yes | Yes | Yes | Yes | Yes |
| Band 7 | | | | | | |
| Luna 2 | Gabriel   | Yes | Yes | Yes | Yes | No |
| Revolution | Camira | Yes | Yes | Yes | Yes | Yes |
| Vintage L | Camira | Yes | Harc Tub only | Yes | No | Yes |
| Divina 3 | Kvadrat    | Yes | Yes | Yes | Yes | Yes |
| Band 8 | | | | | | |
| Black leather | | Yes | Yes | Yes | Yes | Yes |
| Band 10 | | | | | | |
| Leather, coloured | | Yes | Yes | Yes | Yes | Yes |

| | | |
|-------------------------------------------------------------------------------------|--------------------------------|---------------------------------------------------------------------------------------------------------------------------------------------|
|  | People Certification | Certified for low VOC i.e. Oeko-tex, Greenguard Gold, Indoor Air Quality etc. |
|  | Planet Certification | Certified for low environmental impact i.e. Ecolabel, Cradle-to-cradle etc. |
|  | Recycled materials | Using either post-industrial or post-consumer recycled fibres. Using less energy and resources whilst resolving a potential waste issue. |
|  | 100% Natural material | Natural fibres like wool and hemp are naturally fire retardant and therefore may not need added FR chemicals (depending on requirements). |
|  | Less resource intensive | Materials that use less water, energy or chemicals within production. |

§ 1 Conclusion of Agreement

These general Terms of Sale and Delivery apply unless specifically derogated from by other written agreement.

§ 2 Prices and Payment – Retention of Title

All sales are made at prices in SEK applicable at the date of delivery. All prices are excl. VAT, public dues of any nature, packaging etc., unless otherwise specifically agreed and confirmed in writing by Vendor. Price stipulations in price charts are without obligation and may at any time be changed without prior notice. Current prices are listed in the newest updated price list. For goods not yet delivered, Vendor is entitled to increase the price equivalent to any price increase made by Vendor's subcontractors.

Payment is made cash with 30% before the production is started and the remaining 70% no later than 14 days before delivery, unless otherwise specifically agreed and confirmed in writing by Vendor.

Credit can be agreed if the Vendor can obtain satisfactory credit insurance from the Buyer. If the Vendor's insurance company revokes the credit insurance, the Vendor has the right to demand full payment immediately and without further notice.

On late payment default interest is charged with addition of interest at a rate of 2% per month started. If payment is not made on time the Vendor is entitled immediately and without further notice to cancel the sale.

The property right of the goods sold remains with Vendor in all respects until Buyer effectively has paid the purchase price and all other costs attached to the purchase.

§ 3 Time and Place of Delivery of Vendor's Goods

Times of delivery are approximate and not binding, unless otherwise specifically agreed and confirmed in writing by Vendor. Vendor cannot be held accountable for any costs due to delay.

All deliveries to the countries below* are made 'CIP' (INCOTERMS 2020) to the Buyer's place of business or warehouse within normal working hours and via truck without a lift. However, only for bridged islands. Deliveries to all other countries and non-bridged islands are made 'EX WORKS' (INCOTERMS 2020).

Deliveries with a total order value of less than SEK 11.000 incur a shipping fee of SEK 1.600. Orders that only contain spare parts are exempt from shipping fees.

The risk of the goods purchased passes to Buyer on delivery. In cases where Buyer is committed to collect the goods and Vendor keeps them ready, the risk passes to Buyer already at that time.

For deliveries that deviate from the above, a shipping fee is calculated. This includes e.g. delivery directly to the end customer, delivery by lift, delivery by small truck, etc., as well as if there are special requirements for the time of delivery, e.g. delivery on a specific day of the week or within a specific period of the day.

Contact (name, e-mail address and telephone number) and opening hours for receiving goods as well as any special requirements for trucks and delivery equipment.

In the event of unsuccessful delivery due to missing or incorrect information from Buyer, the Vendor reserves the right to invoice the additional costs incurred.

*The following countries are covered: Denmark, Norway (with zip code lower than 7995), Sweden, Finland, Germany, Benelux, France, Switzerland, Austria, Poland, Estonia, Latvia, and Lithuania.

§ 4 Delays by Vendor

If the Vendor becomes aware that he will be unable to meet the stipulated time of delivery, or that a delay on his part is likely to occur, he shall without undue delay notify the Buyer in writing stating the cause of the delay, and wherever possible, the time when delivery is likely to be made. Where a delay in delivery is due to any of the circumstances set forth in article 10 hereof (force majeure) or to acts or omissions on the part of the Buyer, the time of delivery shall be postponed for a period corresponding to the period in which the Vendor has been unable to deliver due to Buyer's conditions or conditions covered by article 10. This provision shall apply whether the cause of delay occurs before or after the end of the stipulated time of delivery. The Buyer shall not be entitled to cancel the agreement owing to delays in delivery attributable to the Vendor except where such delay exceeds three months.

The Buyer shall not be able to claim compensation owing to delays on the part of Vendor.

§ 5 Delays by Buyer

If the Buyer becomes aware that he will not be able to take delivery of/collect the goods by the stipulated date – or if a delay on his part is likely to occur – he shall forthwith notify the Vendor in writing, stating the cause of delay and, wherever possible, the time when taking delivery/collection of the goods shall be possible. In such cases the Buyer shall pay the purchase price and all other costs to the Vendor as if delivery of the relevant goods had taken place.

Should the Vendor not be able to deliver owing to conditions on the part of the Buyer, the Vendor shall make sure that the goods are properly stored for the Buyer's account and at the Buyer's risk. The Vendor shall at the Buyer's request insure the goods for the Buyer's account. The Vendor shall have the right to call upon the Buyer in writing to take delivery of the goods within a time limit of 15 days. Where the Buyer fails to do so within the same time limit for reasons that are not attributable to the Vendor, the Vendor shall be entitled to cancel the agreement by written notice to the Buyer. In such case, the Vendor shall have the right to demand compensation for any loss he has incurred from the Buyer's non-performance.

If the Buyer unjustifiably allows remediation to be carried out by a third party, the Buyer cannot demand his costs covered by the Vendor.

§ 6 Nonconformity

If it becomes apparent that the goods do not conform with the agreement, Vendor has the option to effect repairs or otherwise to redress. The Vendor is under no circumstances responsible for operating-, time-, profit-, or other indirect losses of the Buyer or the Buyer's customers or other users of the delivery. The Buyer cannot claim compensation to cover the costs that may be incurred during removal or reassembly.

Only if within a reasonable time and on a reasonable number of repair attempts Vendor is not able to correct or make good the defect etc., Buyer may arrange for repair by third party or claim a reduction in the purchase

price. If Buyer unjustly arranges for third party to repair, Buyer may not in such cases claim cover of his costs in respect thereof from Vendor.

In cases of short deliveries (quantitative lack of conformity) Vendor may make subsequent deliveries within a reasonable time, in which case Buyer may not invoke breach.

The Buyer shall notify the Vendor in writing of any defects without undue delay after such defects have appeared. Minor knots, differences in shades as well as strong and weak annual rings are signs of genuineness and are not considered to be defects.

Damage to products must be noted on the waybill for goods to be replaced. "Goods received with reservations" is not sufficient. Buyer carries the full risk that Vendor's goods are suited for purposes particularly applicable for Buyer.

If the Buyer has not notified the Vendor within two years from the date of delivery, the Buyer is prevented from making claims in respect of defects, compensation, any warranty claims, or other remedies.

§ 7 Warranties

Vendor always uses first class materials, and our products continuously undergo strict quality control.

Information about testing and standards can be found on our website under the individual products: www.fourdesign.dk

5-year warranty

Vendor provides an extended warranty of 5 years on chairs and tables in our official price list. The warranty covers breakage of frames and damage occurred because of deficient craftsmanship performance under normal use.

The warranty shall lapse if the product shows signs of mishandling abuse or other physical damage. The warranty does not cover those parts of the product which are exposed to abrasion during use.

Spare parts

Spare parts for the furniture product will be available for a period of 5 years from the date of purchase of the product.

The parts will be available without charge during the guarantee period if the goods are found to be faulty during normal use.

A proportionate cost will be charged if the goods were damaged by misuse.

Surfaces

Vendor recommends the use of chrome on stacking chairs and foldable tables. There is no warranty for damage to other surfaces such as Satin chrome and powder coating.

Vendor do not recommend black lacquered veneer on seats or powder painted steel where the chair suspension system is being used.

When stacking upholstered chairs, you may get pressure marks on the fabric. These are temporary and will disappear once the chairs are unstacked.

We rely on the fabric supplier's guarantee, as far as wear, peeling, etc.

§ 8 Limitation of Liability

Vendor is only liable for defects in Vendor's goods if Buyer has used the goods as prescribed and in a sound manner, and according to Vendor's directions, if any. Vendor's liability is limited to defects in Vendor's own goods and not to defects or faults that arise in connection with Vendors.

goods being incorporated in or to those of others. In no circumstances is Vendor liable for any loss on operations, time, profit margin or other indirect losses suffered by Buyer or Buyer's customers or other users of Vendor's goods. Buyer may not claim compensation to cover the costs incidental to dismounting and remounting the objects or installations, in which the goods might be incorporated.

To the extent that Vendor is held liable towards third parties, Buyer must hold Vendor harmless to the extent such liability exceeds the limits set out in these terms. In no event may Vendor's liability for the goods supplied exceed the total price hereof.

§ 9 Product Liability

In the mutual relations between Vendor and Buyer, Vendor excludes any liability for commercial property damage that may be attached to Vendor's goods. If Vendor is met with claims for damages for commercial property damage from Buyer's customers, their customers or other later users of Vendor's goods, Buyer in the relations between Vendor and Buyer is committed to indemnify Vendor for any such claim and to cover Vendor's reasonable costs to any defence against that.

§ 10 Force majeure

The following circumstances shall give rise to exemption from liability if they prevent the performance of the agreement or render such performance unreasonably onerous: Labour conflicts and any other circumstance beyond the control of the Vendor, such as but not limited to fire, war, mobilisation or unforeseen military callups of a corresponding scale, requisitioning, seizure, foreign exchange restrictions, insurrection and civil unrest, lack of transportation, general scarcity of goods, and defects in or delays of deliveries from sub suppliers due to any of the factors set forth in this paragraph.

Circumstances of the type mentioned above, which had occurred prior to the conclusion of this agreement, shall exempt the Vendor from liability only where their influence on the performance of the agreement could not be foreseen by the Vendor at the time when the agreement was entered into. Where the Vendor intends to invoke any exemption from liability grounds set forth in this article, he shall without undue delay notify the Buyer in writing of such grounds.

Notwithstanding any stipulation in these conditions of sale and terms of delivery, either of the parties may cancel the agreement by written notice to the other party where the performance of the agreement is prevented for more than six months by one of the events set forth in this article.

§ 11 In general

Any disputes arising out of or in connection with agreements between Vendor and Buyer are to be settled pursuant to Danish law.

Vendor reserves the right for printing errors. Vendor's liability for the goods supplied exceed the total price hereof.

Last update: January 2024



You are Always Welcome in our Showrooms

Aarhus
+45 4016 6565
Balticagade 15
DK-8000 Aarhus C
Denmark

Copenhagen
+45 2030 7122
Carl Jacobsensvej 16
DK-2500 Valby
Denmark

Odense
+45 6229 1132
Lucernemarken 17-19
DK-5260 Odense S.
Denmark

Oslo
+47 9953 0223
Drammensveien 130
0277 Oslo
Norway

Düsseldorf
+49 1722 8042 42
Düsseldorfer Str 16
DE-40699 Erkrath
Germany

London
20 Old Street
Clerkenwell
London, EC1V 9AB
United Kingdom

Northampton
Caswell Road
Brackmills Industrial Est.
Northampton, NN4 7PW
United Kingdom

Ocee & Four Design products are available worldwide

North America
hightoweraccess.com

Hightower

Oceania
fusefurniture.com.au



China
Novah.cn





We turn good
spaces into great
experiences

OCEEFOUR.COM