

SWEDISH

Price List

2024



ocee & four
DESIGN



Hello, we are Ocee & Four Design!

We are on a mission to turn every good space into a great experience. Experience is about connecting with people, and that is why our furniture is designed with people in mind: How do they connect with others? What inspires and engages them? Where do they feel most comfortable? Who do they spend their time with? Why do they work in the way they do? These questions form the basis of the creative, comfortable, and productive spaces we work with our partners to create.

Our furniture solutions and products are highly curated to suit a variety of needs and spaces. We believe nothing beats family, and our products reflect that. You will find solutions that work together in perfect harmony to create beautiful spaces, while also maintaining their individual characteristics as standalone designs.

Ingenious design, unrivalled functionality, a focus on people, and a healthy dose of wonder – this is how we turn good spaces into great experiences.

FourSure® Family ↗



EU Ecolabel
FourSure®



FourSure® 44



FourSure® 88



FourSure® 90/105



FourSure® 66



FourSure® 77



FourSure® 11



FourSure® 99

FourCast® 2 Family ↗



EU Ecolabel
FourCast® 2



FourCast® 2 Four



FourCast® 2 Line



FourCast® 2 Counter /
High



FourCast® 2 Counter
Four / High Four



FourCast® 2 Wheeler



FourCast® 2 77



FourCast® 2 One



FourCast® 2 Fire
Retardant

FourMe® Family ↗



FourMe® 44



FourMe® 88



FourMe® 66

Share Family ↗



Share Basic



Share Stool



Share Bench

Upholstered Stools ↗



Casino

FourReal® Table Family ↗



FourReal® 74



FourReal® 741 Flake



FourReal® Flex



FourReal® 90



FourReal® 105



FourReal® A 74 /
A XL 74



FourReal® A Flex



FourReal® A 90 /
A XL 90



FourFold®



Acoustic Panels



Tray



Power Cube

Four® Tables ↗



Four® Learning



Four® Eating



Four® Meeting



Four® Standing
90 / 103



Four® Resting
H 51 / 64 / 72,5 / 103



Y-Table

Soft seating ↗



FourPeople®
Family



FourLikes®
Family



FourUs®
Family



Harc
Family

Acoustic ↗



InnoPod®

Links

[Sustainability ↗](#)

[Certificates ↗](#)

[Electrical accessories ↗](#)

[Accessories ↗](#)

[Colour codes ↗](#)

[Fabric bands ↗](#)

[Terms & Conditions ↗](#)

[Contact ↗](#)

Environmental Symbols



Eco-labelled product



Sustainability-marked product or component



Climate calculated product



Product that contains recycled or renewable material



Disassembled product



FEATURES



- The chair consists of 50 % recycled plastic
- Limitation of substances that are harmful to health and the environment
- Linking device optional on frames or under seat
- Matches table height 74 cm, 90 cm & 105 cm
- Polyamide glides as standard
- Stackable on matching trolley

For product information visit oceefour.com ↗

SHELL COLOURS

Standard Polypropylene











FRAME COLOURS

Standard

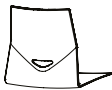

For full colour details [go to page 250](#) ↗

Product	Description (Item nr)	Weight (Kg)	Stacking on floor	Dimensions (mm)	Band	Standard PP (SEK)
	22500 FourSure® 44, Polypropylene shell	5	-		-	2.020
	23200 FourSure® 88, Polypropylene shell	6	-		-	2.479
	23800 FourSure® 90, Polypropylene shell	6.9	-		-	3.409
	23900 FourSure® 105, Polypropylene shell	7.7	-		-	3.492

ACCESSORIES	Description	Weight (Kg)	Dimensions (mm)	Price (SEK)
	CHAIR FEET Felt glides, set of 4 pcs. height + 0,2 cm	1,82 g x 4		208
	CHAIR FEET Teflon glides, set of 4 pcs. Chair height + 0,2 cm	2,75 g x 4		208
	LINKING DEVICE Chair linking	0,4 KG	C/C 535 mm C/C with armrest 585 mm C/C with Loop armrest 625 mm	417
	LINKING DEVICE Chair linking		C/C 540 mm C/C with armrest 540 mm	390
	GRIP HOLE Available for chairs without inside – and full upholstery			189
	SEAT ROW NUMBER - ACSR0201 11 mm - no. 1 -25	29 g		1.579
	SEAT ROW NUMBER - ACSR0202 11 mm - no. 26 -50	29 g		1.579
	SEAT ROW NUMBER - ACSR0101 16 mm - no. 1 -25	29 g		1.579
	SEAT ROW NUMBER - ACSR0102 16 mm - no. 26 -50	29 g		1.579
	CHAIR TROLLEY - 200X0 28 chairs without upholstery	33,5 Kg	1100 x 560 x 1970 mm	8.859



FEATURES

- Armrest options and wooden legs options*
- Linking device under seat options
- Monochrome powder coating on frames options
- Polyamide glides as standard
- Inno® Note tablet options
- Stackable on matching trolley
- Outdoor options
- We do not recommend suspensions for fully upholstered version



For product information visit oceefour.com ↗

SHELL COLOURS

Standard Polypropylene



FRAME COLOURS

Standard





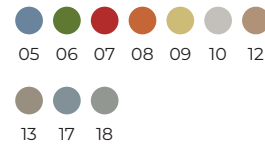



Optional Polypropylene



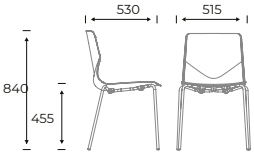

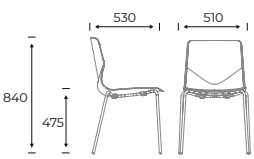

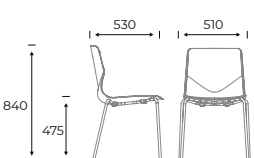

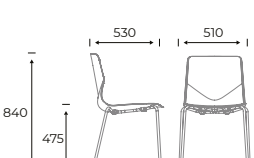
Frame optional*



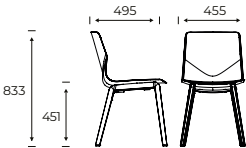

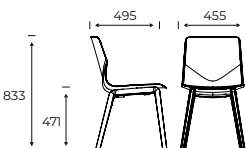

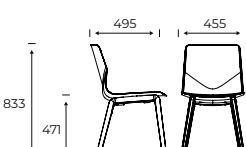

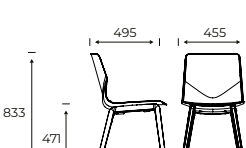

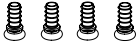

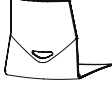
For full colour details [go to page 250](#) ↗

Product	Description (Item nr)	Weight (Kg)	Stacking on floor	Dimensions (mm)	Band	Standard PP (SEK)	Optional PP (SEK)
	22500 FourSure® 44, Polypropylene shell	5	12		-	2.020	2.211
	22510 FourSure® 44, Seat pad	5.9	10		1 2 3 4 5 6 7 8 10	3.282 3.377 3.472 3.566 3.658 3.754 3.849 3.943 4.161	3.473 3.568 3.663 3.757 3.849 3.945 4.040 4.134 4.352
	22520 FourSure® 44, Inside upholstery	6.3	8		1 2 3 4 5 6 7 8 10	4.438 4.629 4.821 5.010 5.202 5.393 5.584 5.774 6.158	4.629 4.820 5.012 5.201 5.393 5.584 5.775 5.965 6.349
	22530 FourSure® 44, Fully upholstered	5.7	6		1 2 3 4 5 6 7 8 10	4.719 4.940 5.161 5.382 5.601 5.824 6.044 6.265 6.748	

Product	Description (Item nr)	Weight (Kg)	Stacking on floor	Dimensions (mm)	Band	Standard PP (SEK)	Optional PP (SEK)
	22600 FourSure® 44 with Armrests, Polypropylene shell	5.6	12		-	3.174	3.365
	22610 FourSure® 44 with Armrests, Seat pad	6.4	10		1 2 3 4 5 6 7 8 10	4.436 4.531 4.626 4.720 4.812 4.908 5.003 5.097 5.315	4.627 4.722 4.817 4.911 5.003 5.099 5.194 5.288 5.506
	22620 FourSure® 44 with Armrests, Inside upholstery	6.8	8		1 2 3 4 5 6 7 8 10	5.592 5.783 5.975 6.164 6.356 6.547 6.738 6.928 7.312	5.783 5.974 6.166 6.355 6.547 6.738 6.929 7.119 7.503
	22630 FourSure® 44 with Armrests, Fully upholstered	6.2	6		1 2 3 4 5 6 7 8 10	5.873 6.094 6.315 6.536 6.755 6.978 7.198 7.419 7.902	
	22700 FourSure® 44 with Loop Armrests, Polypropylene shell	6.1	12		-	3.174	3.365
	22710 FourSure® 44 with Loop Armrests, Seat pad	6.9	10		1 2 3 4 5 6 7 8 10	4.436 4.531 4.626 4.720 4.812 4.908 5.003 5.097 5.315	4.627 4.722 4.817 4.911 5.003 5.099 5.194 5.288 5.506
	22720 FourSure® 44 with Loop Armrests, Inside upholstery	7.3	8		1 2 3 4 5 6 7 8 10	5.592 5.783 5.975 6.164 6.356 6.547 6.738 6.928 7.312	5.783 5.974 6.166 6.355 6.547 6.738 6.929 7.119 7.503
	22730 FourSure® 44 with Loop Armrests, Fully upholstered	6.8	6		1 2 3 4 5 6 7 8 10	5.873 6.094 6.315 6.536 6.755 6.978 7.198 7.419 7.902	



Product	Description (Item nr)	Weight (Kg)	Stacking on floor	Dimensions (mm)	Band	Standard PP (SEK)	Optional PP (SEK)
	22500 FourSure® 44, Polypropylene shell, Oak lacquered	5	-		-	3.748	3.939
	22510 FourSure® 44, Seat pad, Oak lacquered	5.9	-		1 2 3 4 5 6 7 8 10	5.010 5.105 5.200 5.294 5.386 5.482 5.577 5.671 5.889	5.201 5.296 5.391 5.485 5.577 5.673 5.768 5.862 6.080
	22520 FourSure® 44, Inside upholstery, Oak lacquered	6.3	-		1 2 3 4 5 6 7 8 10	6.166 6.357 6.549 6.738 6.930 7.121 7.312 7.502 7.886	6.357 6.548 6.740 6.929 7.121 7.312 7.503 7.693 8.077
	22530 FourSure® 44, Fully upholstered, Oak lacquered	5.7	-		1 2 3 4 5 6 7 8 10	6.447 6.668 6.889 7.110 7.329 7.552 7.772 7.993 8.476	

ACCESSORIES	Description	Weight (Kg)	Dimensions (mm)	Price (SEK)
	CHAIR FEET Felt glides, set of 4 pcs. height + 0,2 cm	1,82 g x 4		208
	CHAIR FEET Set of 4 pcs. Noise reducing ferrule with big diameter (reduces pressure marks) Chair height + 0,8 cm	4,8 g x 4		276
	CHAIR FEET Noise reducing ferrule with felt, set of 4 pcs. Chair height + 1 cm	6,6 g x 4		276
	CHAIR FEET Teflon glides, set of 4 pcs. Chair height + 0,2 cm	2,75 g x 4		208
	LINKING DEVICE Chair linking	0,4 KG	C/C 535 mm C/C with armrest 585 mm C/C with Loop armrest 625 mm	417
	GRIP HOLE Available for chairs without inside – and full upholstery			189
	INNO Inno® Note in black, removable and foldable. Not available for chairs with Loop armrest and chairs with wooden legs.	1,4 KG	225 x 325 x 10 mm	1.522
	SEAT ROW NUMBER - ACSR0101 16 mm - no. 1 -25	29 g		1.579
	SEAT ROW NUMBER - ACSR0102 16 mm - no. 26 -50	29 g		1.579
	INNO@NOTE TROLLEY - 20100007 Trolley for Inno® Note. Room for 51 Inno® Notes.	58,5 Kg	1532 x 662 x 1199 mm	19.942
	CHAIR TROLLEY - 200X0 28 chairs without upholstery	33,5 Kg	1100 x 560 x 1970 mm	8.859
	CHAIR TROLLEY - 200X0 20 chairs with seat pad / inside upholstery or 18 chairs with full upholstery	33,5 Kg	1100 x 560 x 1910 / 1980 mm	10.373
	SACK TROLLEY - 200X1 12 chairs without upholstery, 10 chairs with seat pad / inside upholstery or 6 chairs with full upholstery			4.918

FourSure® 44

Design by Strand+Hvass

[Content ↗](#)

SURCHARGE		Price (SEK)
FRAME OPTIONAL	 7 A D E F M N O Q S T	194
	 V	476



FEATURES

- Armrest options
- Linking device optional on frames or under seat
- Monochrome powder coating on frames options
- Polyamide glides as standard
- Inno® Note tablet options
- Stackable on matching trolley
- Outdoor options
- We do not recommend suspensions for fully upholstered version

For product information visit oceefour.com ↗

SHELL COLOURS

Standard Polypropylene



FRAME COLOURS

Standard





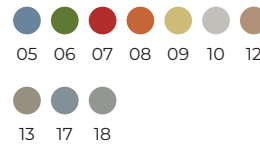



Optional Polypropylene



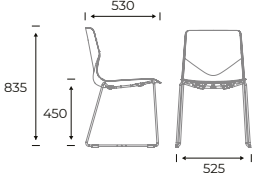

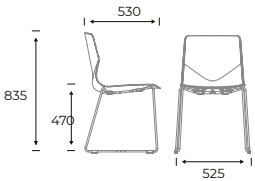

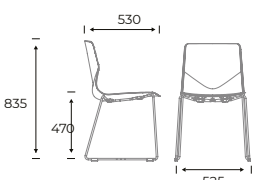

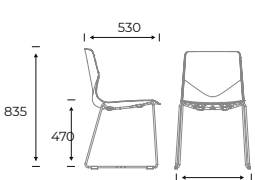

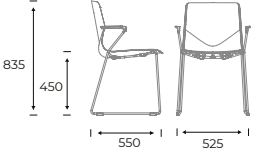

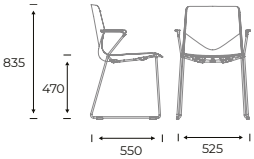

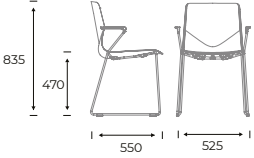

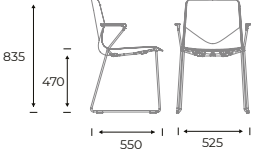

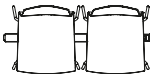
Frame optional*

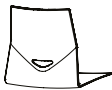

For full colour details [go to page 250](#) ↗

Product	Description (Item nr)	Weight (Kg)	Stacking on floor	Dimensions (mm)	Band	Standard PP (SEK)	Optional PP (SEK)
	23200 FourSure® 88, Polypropylene shell	6	12		-	2.479	2.670
	23210 FourSure® 88, Seat pad	6.8	10		1 2 3 4 5 6 7 8 10	3.741 3.836 3.931 4.025 4.117 4.213 4.308 4.402 4.620	3.932 4.027 4.122 4.216 4.308 4.404 4.499 4.593 4.811
	23220 FourSure® 88, Inside upholstery	7.2	10		1 2 3 4 5 6 7 8 10	4.897 5.088 5.280 5.469 5.661 5.852 6.043 6.233 6.617	5.088 5.279 5.471 5.660 5.852 6.043 6.234 6.424 6.808
	23230 FourSure® 88, Fully upholstered	6.6	8		1 2 3 4 5 6 7 8 10	5.178 5.399 5.620 5.841 6.060 6.283 6.503 6.724 7.207	

Product	Description (Item nr)	Weight (Kg)	Stacking on floor	Dimensions (mm)	Band	Standard PP (SEK)	Optional PP (SEK)
	23300 FourSure® 88 with Armrests, Polypropylene shell	6.7	12		-	3.609	3.800
	23310 FourSure® 88 with Armrests, Seat pad	7.5	10		1 2 3 4 5 6 7 8 10	4.871 4.966 5.061 5.155 5.247 5.343 5.438 5.532 5.750	5.062 5.157 5.252 5.346 5.438 5.534 5.629 5.723 5.941
	23320 FourSure® 88 with Armrests, Inside upholstery	7.9	10		1 2 3 4 5 6 7 8 10	6.027 6.218 6.410 6.599 6.791 6.982 7.173 7.363 7.747	6.218 6.409 6.601 6.790 6.982 7.173 7.364 7.554 7.938
	23330 FourSure® 88 with Armrests, Fully upholstered	7.4	8		1 2 3 4 5 6 7 8 10	6.308 6.529 6.750 6.971 7.190 7.413 7.633 7.854 8.337	

ACCESSORIES	Description	Weight (Kg)	Dimensions (mm)	Price (SEK)
	CHAIR FEET Felt glides, set of 4 pcs. height + 0,2 cm	1,82 g x 4		208
	CHAIR FEET Teflon glides, set of 4 pcs. Chair height + 0,2 cm	2,75 g x 4		208
	LINKING DEVICE Chair linking	0,4 KG	C/C 535 mm C/C with armrest 585 mm C/C with Loop armrest 625 mm	417
	LINKING DEVICE Chair linking		C/C 540 mm C/C with armrest 540 mm	390
	GRIP HOLE Available for chairs without inside – and full upholstery			189
	INNO Inno® Note in black, removable and foldable. Not available for chairs with Loop armrest and chairs with wooden legs.	1,4 KG	225 x 325 x 10 mm	1.522
	SEAT ROW NUMBER - ACSR0201 11 mm - no. 1 -25	29 g		1.579
	SEAT ROW NUMBER - ACSR0202 11 mm - no. 26 -50	29 g		1.579
	INNO@NOTE TROLLEY - 20100007 Trolley for Inno® Note. Room for 51 Inno® Notes.	58,5 Kg	1532 x 662 x 1199 mm	19.942
	CHAIR TROLLEY - 200X0 35 chairs without upholstery	33,5 Kg	1100 x 560 x 1970 mm	8.859
	CHAIR TROLLEY - 200X0 20 chairs with seat pad / inside upholstery or 18 chairs with full upholstery	33,5 Kg	1100 x 560 x 1910 / 1980 mm	10.373
	SACK TROLLEY - 200X1 12 chairs without upholstery, 10 with seat pad / inside upholstery or 8 chairs with full upholstery			4.918
SURCHARGE				Price (SEK)
FRAME OPTIONAL	 7 A D E F M N O Q S T			194



FEATURES

- Fits table height 90 cm
- Stackable on floor
- Polyamide glides as standard
- Monochrome powder coating on frames options
- Outdoor options
- We do not recommend suspensions to fully upholstered version



For product information visit oceefour.com ↗

SHELL COLOURS

Standard Polypropylene



FRAME COLOURS

Standard



Optional Polypropylene

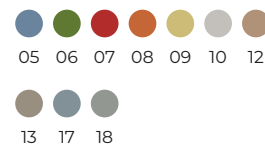







Frame optional*

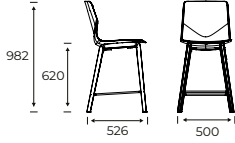

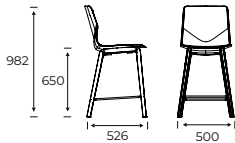
For full colour details [go to page 250](#) ↗

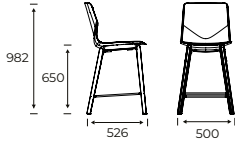
Product	Description (Item nr)	Weight (Kg)	Stacking on floor	Dimensions (mm)	Band	Standard PP (SEK)	Optional PP (SEK)
	23800 FourSure® 90, Polypropylene shell	6.9	4		-	3.409	3.600
	23810 FourSure® 90, Seat pad	7.8	4		1 2 3 4 5 6 7 8 10	4.671 4.766 4.861 4.955 5.047 5.143 5.238 5.332 5.550	4.862 4.957 5.052 5.146 5.238 5.334 5.429 5.523 5.741
	23820 FourSure® 90, Inside upholstery	8.1	4		1 2 3 4 5 6 7 8 10	5.827 6.018 6.210 6.399 6.591 6.782 6.973 7.163 7.547	6.018 6.209 6.401 6.590 6.782 6.973 7.164 7.354 7.738
	23830 FourSure® 90, Fully upholstered	7.6	4		1 2 3 4 5 6 7 8 10	6.108 6.329 6.550 6.771 6.990 7.213 7.433 7.654 8.137	

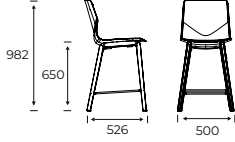
Product	Description (Item nr)	Weight (Kg)	Stacking on floor	Dimensions (mm)	Band	Standard PP (SEK)	Optional PP (SEK)
	23800 FourSure® 90, Polypropylene shell, Oak lacquered	6.9	-		-	5.170	5.361
	23810 FourSure® 90, Seat pad, Oak lacquered	7.8	-		1 2 3 4 5 6 7 8 10	6.432 6.527 6.622 6.716 6.808 6.904 6.999 7.093 7.311	6.623 6.718 6.813 6.907 6.999 7.095 7.190 7.284 7.502
	23820 FourSure® 90, Inside upholstery, Oak lacquered	8.1	-		1 2 3 4 5 6 7 8 10	7.588 7.779 7.971 8.160 8.352 8.543 8.734 8.924 9.308	7.779 7.970 8.162 8.351 8.543 8.734 8.925 9.115 9.499
	23830 FourSure® 90, Fully upholstered, Oak lacquered	7.6	-		1 2 3 4 5 6 7 8 10	7.869 8.090 8.311 8.532 8.751 8.974 9.194 9.415 9.898	

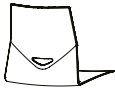
ACCESSORIES	Description	Weight (Kg)	Dimensions (mm)	Price (SEK)
	CHAIR FEET Felt glides, set of 4 pcs. height + 0,2 cm	1,82 g x 4		208
	CHAIR FEET Teflon glides, set of 4 pcs. Chair height + 0,2 cm	2,75 g x 4		208
	GRIP HOLE Available for chairs without inside – and full upholstery			189

SURCHARGE		Price (SEK)
FRAME OPTIONAL		194
	V	475



FEATURES

- Fits table height 105 cm
- Stackable on floor
- Polyamide glides as standard
- Monochrome powder coating on frames options
- Outdoor options
- We do not recommend suspensions to fully upholstered version



For product information visit oceefour.com ↗

SHELL COLOURS

Standard Polypropylene



FRAME COLOURS

Standard



Optional Polypropylene

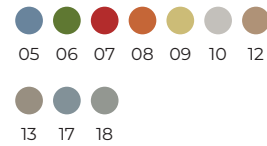







Frame optional*

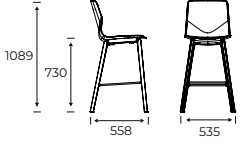

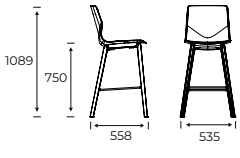
For full colour details [go to page 250](#) ↗

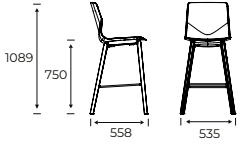
Product	Description (Item nr)	Weight (Kg)	Stacking on floor	Dimensions (mm)	Band	Standard PP (SEK)	Optional PP (SEK)
	23900 FourSure® 105, Polypropylene shell	7.7	4		-	3.492	3.683
	23910 FourSure® 105, Seat pad	8.5	4		1 2 3 4 5 6 7 8 10	4.754 4.849 4.944 5.038 5.130 5.226 5.321 5.415 5.633	4.945 5.040 5.135 5.229 5.321 5.417 5.512 5.606 5.824
	23920 FourSure® 105, Inside upholstery	8.9	4		1 2 3 4 5 6 7 8 10	5.910 6.101 6.293 6.482 6.674 6.865 7.056 7.246 7.630	6.101 6.292 6.484 6.673 6.865 7.056 7.247 7.437 7.821
	23930 FourSure® 105, Fully upholstered	8.4	4		1 2 3 4 5 6 7 8 10	6.191 6.412 6.633 6.854 7.073 7.296 7.516 7.737 8.220	

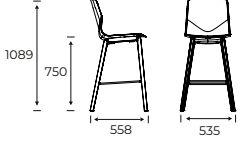
Product	Description (Item nr)	Weight (Kg)	Stacking on floor	Dimensions (mm)	Band	Standard PP (SEK)	Optional PP (SEK)
	23900 FourSure® 105, Polypropylene shell, Oak lacquered	7.7	-		-	5.366	5.557
	23910 FourSure® 105, Seat pad, Oak lacquered	8.5	-		1 2 3 4 5 6 7 8 10	6.628 6.723 6.818 6.912 7.004 7.100 7.195 7.289 7.507	6.819 6.914 7.009 7.103 7.195 7.291 7.386 7.480 7.698
	23920 FourSure® 105, Inside upholstery, Oak lacquered	8.9	-		1 2 3 4 5 6 7 8 10	7.784 7.975 8.167 8.356 8.548 8.739 8.930 9.120 9.504	7.975 8.166 8.358 8.547 8.739 8.930 9.121 9.311 9.695
	23930 FourSure® 105, Fully upholstered, Oak lacquered	8.4	-		1 2 3 4 5 6 7 8 10	8.065 8.286 8.507 8.728 8.947 9.170 9.390 9.611 10.094	

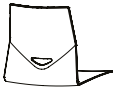
ACCESSORIES	Description	Weight (Kg)	Dimensions (mm)	Price (SEK)
	CHAIR FEET Felt glides, set of 4 pcs. height + 0,2 cm	1,82 g x 4		208
	CHAIR FEET Teflon glides, set of 4 pcs. Chair height + 0,2 cm	2,75 g x 4		208
	GRIP HOLE Available for chairs without inside – and full upholstery			189

SURCHARGE		Price (SEK)
FRAME OPTIONAL		194
	V	474



FEATURES

- Inno® Tab, flexible and rotating writing tablet options
- Gas lift, 41 - 57,5 cm
- Free Float options
- Black base with castors as standard
- Aluminium base options
- We do not recommend suspensions to fully upholstered version



For product information visit oceefour.com ↗

SHELL COLOURS

Standard Polypropylene



FRAME COLOURS

Standard





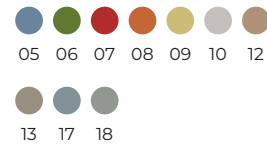



Optional Polypropylene



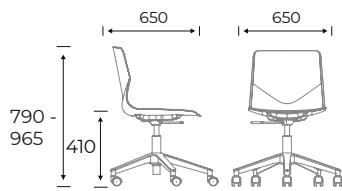

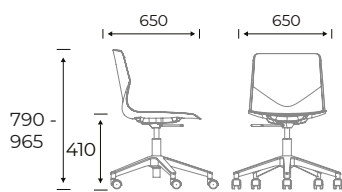

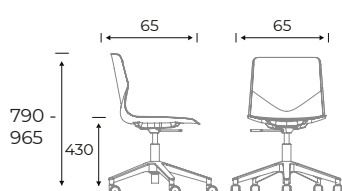

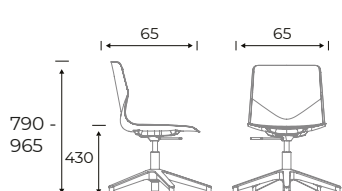

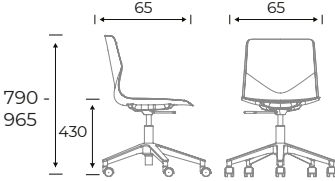

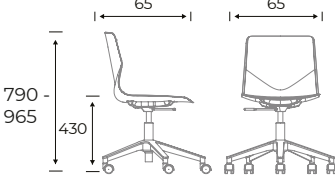

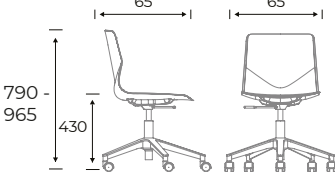

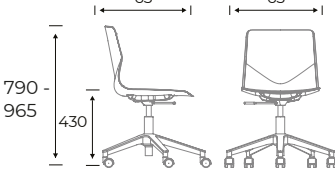





Frame optional*



For full colour details [go to page 250](#) ↗

Product	Description (Item nr)	Weight (Kg)	Dimensions (mm)	Band	Standard PP (SEK)	Optional PP (SEK)
	25004 FourSure® 66, Polypropylene shell, Without tilt with gas	7.4		-	2.783	2.974
	25005 FourSure® 66, Polypropylene shell, With tilt with gas	7.5		-	3.147	3.338
	25014 FourSure® 66, Seat pad, Without tilt with gas	8		1 2 3 4 5 6 7 8 10	4.045 4.140 4.235 4.329 4.421 4.517 4.612 4.706 4.924	4.236 4.331 4.426 4.520 4.612 4.708 4.803 4.897 5.115
	25015 FourSure® 66, Seat pad, With tilt with gas	8		1 2 3 4 5 6 7 8 10	4.409 4.504 4.599 4.693 4.785 4.881 4.976 5.070 5.288	4.600 4.695 4.790 4.884 4.976 5.072 5.167 5.261 5.479

Product	Description (Item nr)	Weight (Kg)	Dimensions (mm)	Band	Standard PP (SEK)	Optional PP (SEK)
	25024 FourSure® 66, Inside upholstery, Without tilt with gas	8.4		1 2 3 4 5 6 7 8 10	5.201 5.392 5.584 5.773 5.965 6.156 6.347 6.537 6.921	5.392 5.583 5.775 5.964 6.156 6.347 6.538 6.728 7.112
	25025 FourSure® 66, Inside upholstery, With tilt with gas	8.4		1 2 3 4 5 6 7 8 10	5.565 5.756 5.948 6.137 6.329 6.520 6.711 6.901 7.285	5.756 5.947 6.139 6.328 6.520 6.711 7.092 7.476
	25034 FourSure® 66, Fully upholstered, Without tilt with gas	7.8		1 2 3 4 5 6 7 8 10	5.482 5.703 5.924 6.145 6.364 6.587 6.807 7.028 7.511	
	25035 FourSure® 66, Fully upholstered, With tilt with gas	13.7		1 2 3 4 5 6 7 8 10	5.846 6.067 6.288 6.509 6.728 6.951 7.171 7.392 7.875	
	24905 FourSure® 66 with Loop Armrests, Polypropylene shell, With tilt with gas	8.7		-	4.291	4.482
	24915 FourSure® 66 with Loop Armrests, Seat pad, With tilt with gas	9.4		1 2 3 4 5 6 7 8 10	5.553 5.648 5.743 5.837 5.929 6.025 6.120 6.214 6.432	5.744 5.839 5.934 6.028 6.120 6.216 6.311 6.405 6.623
	24925 FourSure® 66 with Loop Armrests, Inside upholstery, With tilt with gas	9.7		1 2 3 4 5 6 7 8 10	6.709 6.900 7.092 7.281 7.473 7.664 7.855 8.045 8.429	6.900 7.091 7.283 7.472 7.664 7.855 8.046 8.236 8.620
	24935 FourSure® 66 with Loop Armrests, Fully upholstered, With tilt with gas	9.2		1 2 3 4 5 6 7 8 10	6.990 7.211 7.432 7.653 7.872 8.095 8.315 8.536 9.019	

ACCESSORIES	Description	Weight (Kg)	Dimensions (mm)	Price (SEK)
	HOOK Hook in black			47
	CHAIR FEET Standard polymide glides. Chair height + 0,2 cm			
	CHAIR FEET Castor with breaks, hard			599
	FOOTRING Gas lift including footring Spand 41 cm. - 57,5 cm.		585 - 845 mm	1.368
	With GS certification			1.489
	INNO Foldable Inno® Tab in black with integrated cup holder and dashboard for tablet and phone.	2,7 KG	520 x 320 x 23 mm	2.125
SURCHARGE				Price (SEK)
FRAME OPTIONAL	 4			643



FEATURES

- Armrest options
- Stackable on floor
- Monochrome powder coating on frames options
- We do not recommend suspensions for fully upholstered version



For product information visit oceefour.com ↗

SHELL COLOURS

Standard Polypropylene



Optional Polypropylene

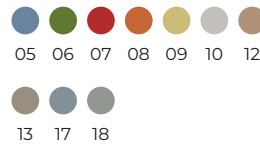

FRAME COLOURS

Standard



Frame optional*









For full colour details [go to page 250](#) ↗

Product	Description (Item nr)	Weight (Kg)	Stacking on floor	Dimensions (mm)	Band	Standard PP (SEK)	Optional PP (SEK)
	22800 FourSure® 77, Polypropylene shell	6	7		-	2.464	2.655
	22810 FourSure® 77, Seat pad	6.9	5		1 2 3 4 5 6 7 8 10	3.726 3.821 3.916 4.010 4.102 4.198 4.293 4.387 4.605	3.917 4.012 4.107 4.201 4.293 4.389 4.484 4.578 4.796
	22820 FourSure® 77, Inside upholstery	7.3	5		1 2 3 4 5 6 7 8 10	4.882 5.073 5.265 5.454 5.646 5.837 6.028 6.218 6.602	5.073 5.264 5.456 5.645 5.837 6.028 6.219 6.409 6.793
	22830 FourSure® 77, Fully upholstered	6.8	5		1 2 3 4 5 6 7 8 10	5.163 5.384 5.605 5.826 6.045 6.268 6.488 6.709 7.192	

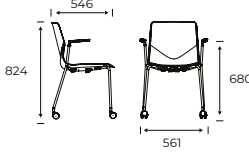
FourSure® 77

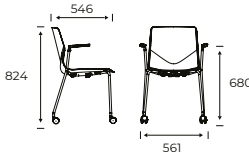
Design by Strand+Hvass

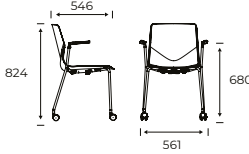
[Content ↗](#)

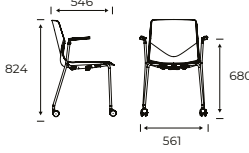
Product	Description (Item nr)	Weight (Kg)	Stacking on floor	Dimensions (mm)	Band	Standard PP (SEK)	Optional PP (SEK)
	22900 FourSure® 77 with Armrests, Polypropylene shell	7.5	-		-	3.618	3.809
	22910 FourSure® 77 with Armrests, Seat pad	8	-		1 2 3 4 5 6 7 8 10	4.880 4.975 5.070 5.164 5.256 5.352 5.447 5.541 5.759	5.071 5.166 5.261 5.355 5.447 5.543 5.638 5.732 5.950
	22920 FourSure® 77 with Armrests, Inside upholstery	8.4	-		1 2 3 4 5 6 7 8 10	6.036 6.227 6.419 6.608 6.800 6.991 7.182 7.372 7.756	6.227 6.418 6.610 6.799 6.991 7.182 7.373 7.563 7.947
	22930 FourSure® 77 with Armrests, Fully upholstered	8.2	-		1 2 3 4 5 6 7 8 10	6.317 6.538 6.759 6.980 7.199 7.422 7.642 7.863 8.346	

ACCESSORIES	Description	Weight (Kg)	Dimensions (mm)	Price (SEK)
	GRIP HOLE Available for chairs without inside – and full upholstery			189

SURCHARGE	Price (SEK)
FRAME OPTIONAL 	194



FEATURES

- Armrest options
- Swivel with freefloat in seat/back
- Return mechanism options
- Polyamide glides as standard
- Teflon or felt glides and soft castor options
- Soft castor options (fixed cone without swivel and return)
- We do not recommend suspensions to fully upholstered version

For product information visit oceefour.com ↗

SHELL COLOURS

Standard Polypropylene



FRAME COLOURS

Standard





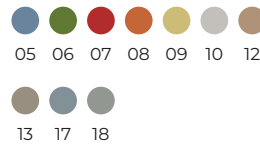





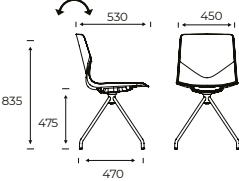

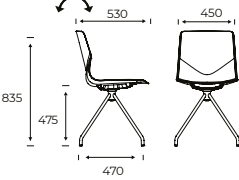

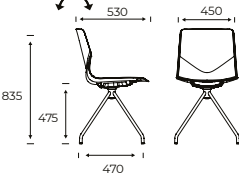

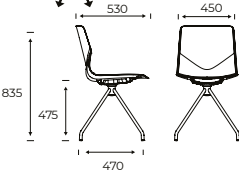

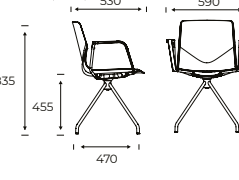

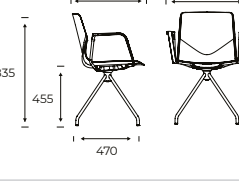

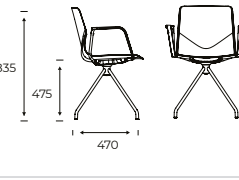

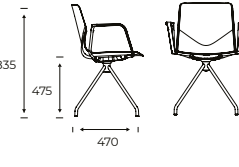
Optional Polypropylene



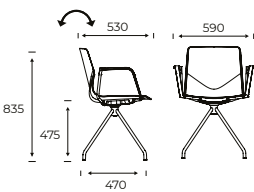

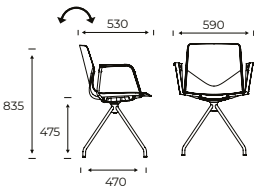
For full colour details [go to page 250](#) ↗

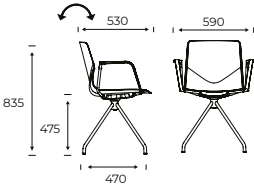
Product	Description (Item nr)	Weight (Kg)	Dimensions (mm)	Band	Standard PP (SEK)	Optional PP (SEK)
	23001 FourSure® 11, Polypropylene shell, With tilt	6.7		-	3.627	3.818
	23003 FourSure® 11, Polypropylene shell, With tilt with return	6.6		-	4.800	4.991
	23011 FourSure® 11, Seat pad, With tilt	7.1		1 2 3 4 5 6 7 8 10	4.889 4.984 5.079 5.173 5.265 5.361 5.456 5.550 5.768	5.080 5.175 5.270 5.364 5.456 5.552 5.647 5.741 5.959
	23013 FourSure® 11, Seat pad, With tilt with return	7.1		1 2 3 4 5 6 7 8 10	6.062 6.157 6.252 6.346 6.438 6.534 6.629 6.723 6.941	6.253 6.348 6.443 6.537 6.629 6.725 6.820 6.914 7.132

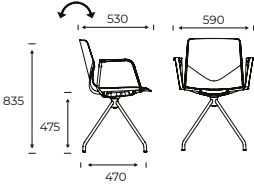
Product	Description (Item nr)	Weight (Kg)	Dimensions (mm)	Band	Standard PP (SEK)	Optional PP (SEK)
	23021 FourSure® 11, Inside upholstery, With tilt	7.5		1 2 3 4 5 6 7 8 10	6.045 6.236 6.428 6.617 6.809 7.000 7.191 7.381 7.765	6.236 6.427 6.619 6.808 7.000 7.191 7.382 7.572 7.956
	23023 FourSure® 11, Inside upholstery, With tilt with return	7.4		1 2 3 4 5 6 7 8 10	7.218 7.409 7.601 7.790 7.982 8.173 8.364 8.554 8.938	7.409 7.600 7.792 7.981 8.173 8.364 8.555 8.745 9.129
	23031 FourSure® 11, Fully upholstered, With tilt	7		1 2 3 4 5 6 7 8 10	6.326 6.547 6.768 6.989 7.208 7.431 7.651 7.872 8.355	
	23033 FourSure® 11, Fully upholstered, With tilt with return	6.9		1 2 3 4 5 6 7 8 10	7.499 7.720 7.941 8.162 8.381 8.604 8.824 9.045 9.528	
	23101 FourSure® 11 with Loop Armrests, Polypropylene shell, With tilt	7.8		-	4.780	4.971
	23103 FourSure® 11 with Loop Armrests, Polypropylene shell, With tilt with return	7.7		-	5.953	6.144
	23111 FourSure® 11 with Loop Armrests, Seat pad, With tilt	8.3		1 2 3 4 5 6 7 8 10	6.042 6.137 6.232 6.326 6.418 6.514 6.609 6.703 6.921	6.233 6.328 6.423 6.517 6.609 6.705 6.800 6.894 7.112
	23113 FourSure® 11 with Loop Armrests, Seat pad, With tilt with return	8.2		1 2 3 4 5 6 7 8 10	7.215 7.310 7.405 7.499 7.591 7.687 7.782 7.876 8.094	7.406 7.501 7.596 7.690 7.782 7.878 7.973 8.067 8.285

Product	Description (Item nr)	Weight (Kg)	Dimensions (mm)	Band	Standard PP (SEK)	Optional PP (SEK)
	23121 FourSure® 11 with Loop Armrests, Inside upholstery, With tilt	8.7		1 2 3 4 5 6 7 8 10	7.198 7.389 7.581 7.770 7.962 8.153 8.344 8.534 8.918	7.389 7.580 7.772 7.961 8.153 8.344 8.535 8.725 9.109
	23123 FourSure® 11 with Loop Armrests, Inside upholstery, With tilt with return	8.6		1 2 3 4 5 6 7 8 10	8.371 8.562 8.754 8.943 9.135 9.326 9.517 9.707 10.091	8.562 8.753 8.945 9.134 9.326 9.517 9.708 9.898 10.282
	23131 FourSure® 11 with Loop Armrests, Fully upholstered, With tilt	7.9		1 2 3 4 5 6 7 8 10	7.479 7.700 7.921 8.142 8.361 8.584 8.804 9.025 9.508	
	23133 FourSure® 11 with Loop Armrests, Fully upholstered, With tilt with return	8.1		1 2 3 4 5 6 7 8 10	8.652 8.873 9.094 9.315 9.534 9.757 9.977 10.198 10.681	

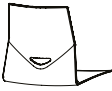
ACCESSORIES	Description	Weight (Kg)	Dimensions (mm)	Price (SEK)
	CHAIR FEET Castors			876
	CHAIR FEET Felt glides, set of 4 pcs. height + 0,2 cm	1,82 g x 4		208
	CHAIR FEET Set of 4 pcs. Noise reducing ferrule with big diameter (reduces pressure marks) Chair height + 0,8 cm	4,8 g x 4		276
	CHAIR FEET Noise reducing ferrule with felt, set of 4 pcs. Chair height + 1 cm	6,6 g x 4		276
	CHAIR FEET Teflon glides, set of 4 pcs. Chair height + 0,2 cm	2,75 g x 4		208
	GRIP HOLE Available for chairs without inside – and full upholstery			189



FEATURES

- Swivel frame with free float seat/back as standard
- Return mechanism options
- Loop Armchair options
- Polyamide glides as standard
- Teflon or felt glides and soft castor options
- Powder coated frame options
- We do not recommend suspensions to fully upholstered version



For product information visit oceefour.com ↗

SHELL COLOURS

Standard Polypropylene



FRAME COLOURS

Standard



Optional Polypropylene

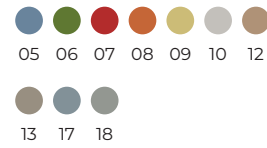









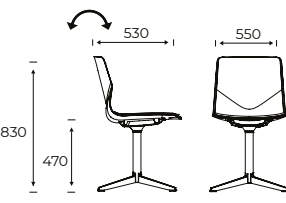

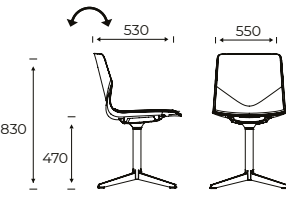

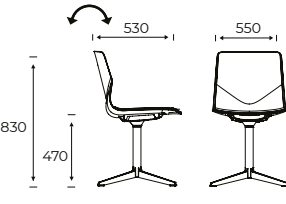

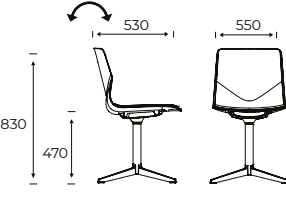

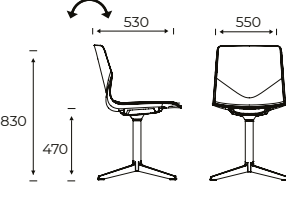

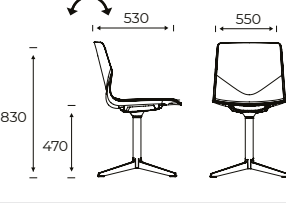

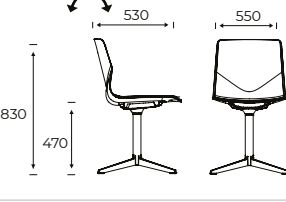

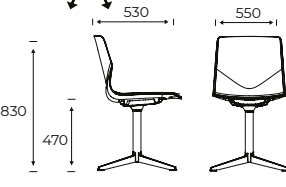



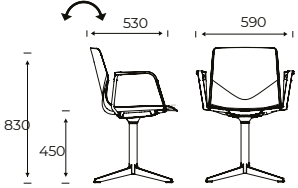

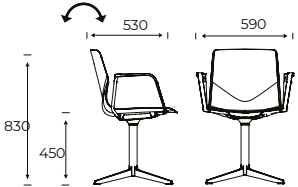

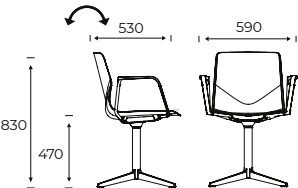
Frame optional*

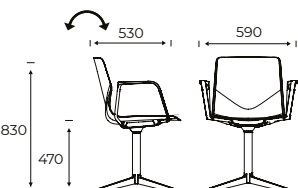

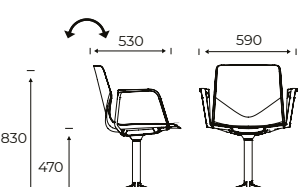

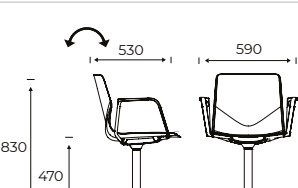

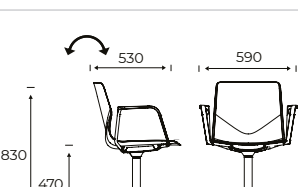

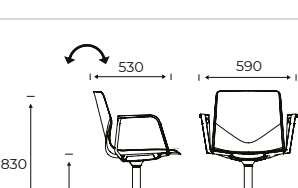
For full colour details [go to page 250](#) ↗

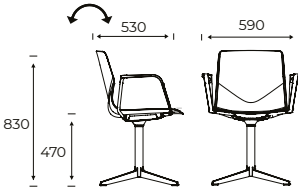
Product	Description (Item nr)	Weight (Kg)	Dimensions (mm)	Band	Standard PP (SEK)	Optional PP (SEK)
	24001 FourSure® 99, Polypropylene shell, With tilt	7.2		-	4.767	4.958
	24003 FourSure® 99, Polypropylene shell, With tilt with return	7.2		-	5.267	5.458
	24005 FourSure® 99, Polypropylene shell, With tilt with gas	7.7		-	5.267	5.458
	24011 FourSure® 99, Seat pad, With tilt	7.7		1 2 3 4 5 6 7 8 10	6.029 6.124 6.219 6.313 6.405 6.501 6.596 6.690 6.908	6.220 6.315 6.410 6.504 6.596 6.692 6.787 6.881 7.099

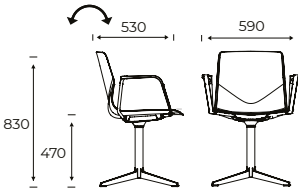
Product	Description (Item nr)	Weight (Kg)	Dimensions (mm)	Band	Standard PP (SEK)	Optional PP (SEK)
	24013 FourSure® 99, Seat pad, With tilt with return	7.7		1 2 3 4 5 6 7 8 10	6.529 6.624 6.719 6.813 6.905 7.001 7.096 7.190 7.408	6.720 6.815 6.910 7.004 7.096 7.192 7.287 7.381 7.599
	24015 FourSure® 99, Seat pad, With tilt with gas	8.6		1 2 3 4 5 6 7 8 10	6.529 6.624 6.719 6.813 6.905 7.001 7.096 7.190 7.408	6.720 6.815 6.910 7.004 7.096 7.192 7.287 7.381 7.599
	24021 FourSure® 99, Inside upholstery, With tilt	8.1		1 2 3 4 5 6 7 8 10	7.185 7.376 7.568 7.757 7.949 8.140 8.331 8.521 8.905	7.376 7.567 7.759 7.948 8.140 8.331 8.522 8.712 9.096
	24023 FourSure® 99, Inside upholstery, With tilt with return	8.1		1 2 3 4 5 6 7 8 10	7.685 7.876 8.068 8.257 8.449 8.640 8.831 9.021 9.405	7.876 8.067 8.259 8.448 8.640 8.831 9.022 9.212 9.596
	24025 FourSure® 99, Inside upholstery, With tilt with gas	9		1 2 3 4 5 6 7 8 10	7.685 7.876 8.068 8.257 8.449 8.640 8.831 9.021 9.405	7.876 8.067 8.259 8.448 8.640 8.831 9.022 9.212 9.596
	24031 FourSure® 99, Fully upholstered, With tilt	7.5		1 2 3 4 5 6 7 8 10	7.466 7.687 7.908 8.129 8.348 8.571 8.791 9.012 9.495	
	24033 FourSure® 99, Fully upholstered, With tilt with return	7.5		1 2 3 4 5 6 7 8 10	7.966 8.187 8.408 8.629 8.848 9.071 9.291 9.512 9.995	
	24035 FourSure® 99, Fully upholstered, With tilt with gas	-		1 2 3 4 5 6 7 8 10	7.966 8.187 8.408 8.629 8.848 9.071 9.291 9.512 9.995	

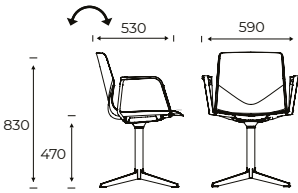
Product	Description (Item nr)	Weight (Kg)	Dimensions (mm)	Band	Standard PP (SEK)	Optional PP (SEK)
	24101 FourSure® 99 with Loop Armrests, Polypropylene shell, With tilt	8.5		-	5.918	6.109
	24103 FourSure® 99 with Loop Armrests, Polypropylene shell, With tilt with return	8.5		-	6.418	6.609
	24105 FourSure® 99 with Loop Armrests, Polypropylene shell, With tilt with gas	9.5		-	6.418	6.609
	24111 FourSure® 99 with Loop Armrests, Seat pad, With tilt	9.1		1 2 3 4 5 6 7 8 10	7.180 7.275 7.370 7.464 7.556 7.652 7.747 7.841 8.059	7.371 7.466 7.561 7.655 7.747 7.843 7.938 8.032 8.250
	24113 FourSure® 99 with Loop Armrests, Seat pad, With tilt with return	9		1 2 3 4 5 6 7 8 10	7.680 7.775 7.870 7.964 8.056 8.152 8.247 8.341 8.559	7.871 7.966 8.061 8.155 8.247 8.343 8.438 8.532 8.750
	24115 FourSure® 99 with Loop Armrests, Seat pad, With tilt with gas	10		1 2 3 4 5 6 7 8 10	7.680 7.775 7.870 7.964 8.056 8.152 8.247 8.341 8.559	7.871 7.966 8.061 8.155 8.247 8.343 8.438 8.532 8.750
	24121 FourSure® 99 with Loop Armrests, Inside upholstery, With tilt	9.4		1 2 3 4 5 6 7 8 10	8.336 8.527 8.719 8.908 9.100 9.291 9.482 9.672 10.056	8.527 8.718 8.910 9.099 9.291 9.482 9.673 9.863 10.247
	24123 FourSure® 99 with Loop Armrests, Inside upholstery, With tilt with return	9.4		1 2 3 4 5 6 7 8 10	8.836 9.027 9.219 9.408 9.600 9.791 9.982 10.172 10.556	9.027 9.218 9.410 9.599 9.791 9.982 10.173 10.363 10.747

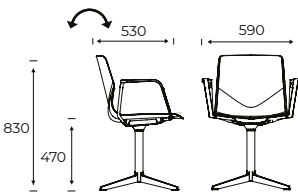
Product	Description (Item nr)	Weight (Kg)	Dimensions (mm)	Band	Standard PP (SEK)	Optional PP (SEK)
	24125 FourSure® 99 with Loop Armrests, Inside upholstery, With tilt with gas	10.4		1 2 3 4 5 6 7 8 10	8.836 9.027 9.219 9.408 9.600 9.791 9.982 10.172 10.556	9.027 9.218 9.410 9.599 9.791 9.982 10.173 10.363 10.747
	24131 FourSure® 99 with Loop Armrests, Fully upholstered, With tilt	8.8		1 2 3 4 5 6 7 8 10	8.617 8.838 9.059 9.280 9.499 9.722 9.942 10.163 10.646	
	24133 FourSure® 99 with Loop Armrests, Fully upholstered, With tilt with return	8.8		1 2 3 4 5 6 7 8 10	9.117 9.338 9.559 9.780 9.999 10.222 10.442 10.663 11.146	
	24135 FourSure® 99 with Loop Armrests, Fully upholstered, With tilt with gas	8.5		1 2 3 4 5 6 7 8 10	9.117 9.338 9.559 9.780 9.999 10.222 10.442 10.663 11.146	

ACCESSORIES	Description	Weight (Kg)	Dimensions (mm)	Price (SEK)
	CHAIR FEET Castors			1.154
	CHAIR FEET Felt glides, set of 4 pcs. height + 0,2 cm	1,82 g x 4		208

SURCHARGE		Price (SEK)
FRAME OPTIONAL	 B C K	1058

EU Ecolabel FourCast® 2

Design by Strand+Hvass

[Content ↗](#)



FEATURES



- The chair consists of 50 % recycled plastic
- Limitation of substances that are harmful to health and the environment
- Linking device optional on frames or under seat
- Matches table height 74 cm, 90 cm & 105 cm
- Polyamide glides as standard
- Stackable on matching trolley

For product information visit oceefour.com ↗

SHELL COLOURS

Standard Polypropylene







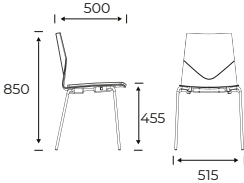

FRAME COLOURS

Standard

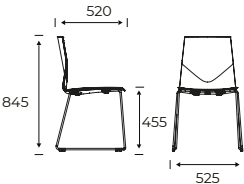

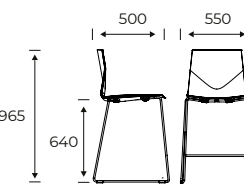

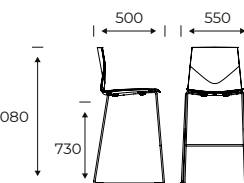
For full colour details [go to page 236](#) ↗





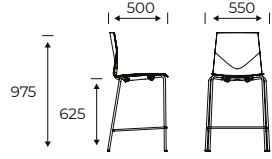

Product	Description (Item nr)	Weight (Kg)	Stacking on floor	Dimensions (mm)	Band	Standard PP (SEK)
	32500 FourCast® 2 Four, Polypropylene shell	4.8	-		-	2.290
	33200 FourCast® 2 Line, Polypropylene shell	5.7	-		-	2.776
	33800 FourCast® 2 Counter, Polypropylene shell	6.6	-		-	3.730
	33900 FourCast® 2 High, Polypropylene shell	7.3	-		-	3.815

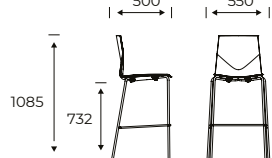
EU Ecolabel FourCast® 2

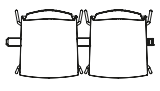
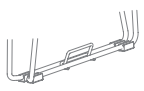
[Content ↗](#)

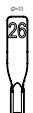
Design by Strand+Hvass

Product	Description (Item nr)	Weight (Kg)	Stacking on floor	Dimensions (mm)	Band	Standard PP (SEK)
	34000 FourCast@ 2 Counter Four, Polypropylene shell	7.7	-		-	3.492
	34100 FourCast@ 2 High Four, Polypropylene shell	6.7	-		-	3.492

ACCESSORIES	Description	Weight (Kg)	Dimensions (mm)	Price (SEK)
	CHAIR FEET Felt glides, set of 4 pcs. height + 0,2 cm	1,82 g x 4		208
	CHAIR FEET Teflon glides, set of 4 pcs. Chair height + 0,2 cm	2,75 g x 4		208
	LINKING DEVICE Chair linking	0,4 KG	C/C 535 mm C/C with armrest 585 mm C/C with Loop armrest 625 mm	417
	LINKING DEVICE Chair linking		C/C 540 mm C/C with armrest 540 mm	390
	GRIP HOLE Available for chairs without inside – and full upholstery			189
	SEAT ROW NUMBER - ACSR0201 11 mm - no. 1 -25	29 g		1.579
	SEAT ROW NUMBER - ACSR0202 11 mm - no. 26 -50	29 g		1.579
	SEAT ROW NUMBER - ACSR0101 16 mm - no. 1 -25	29 g		1.579
	SEAT ROW NUMBER - ACSR0102 16 mm - no. 26 -50	29 g		1.579
	CHAIR TROLLEY - 200X0 25 chairs without upholstery	33,5 Kg	1100 x 560 x 1970 mm	8.859

FourCast® 2 Four

Design by Strand+Hvass

[Content ↗](#)



FEATURES

- Armrest options and wooden legs options*
- Linking device under seat options
- Monochrome powder coating on frames options
- Polyamide glides as standard
- Inno® Note tablet options
- Stackable on matching trolley
- We do not recommend suspensions for fully upholstered versions



For product information visit oceefour.com ↗

SHELL COLOURS

Standard Polypropylene



FRAME COLOURS

Standard





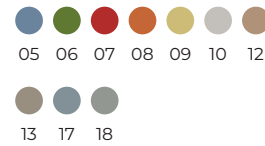



Optional Polypropylene

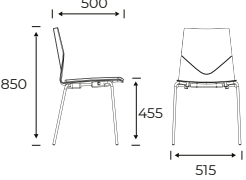

Frame optional*

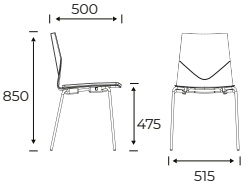

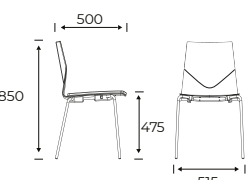

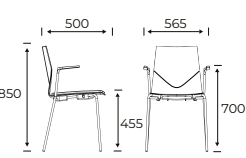



For full colour details [go to page 236](#) ↗



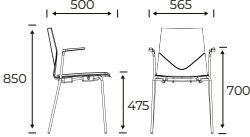

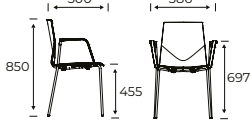

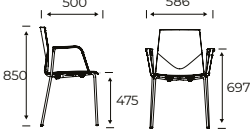

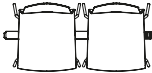

Product	Description (Item nr)	Weight (Kg)	Stacking on floor	Dimensions (mm)	Band	Standard PP (SEK)	Optional PP (SEK)
	32500 FourCast® 2 Four, Polypropylene shell	4.8	12		-	2.290	2.481
	32510 FourCast® 2 Four, Seat pad	5.8	10		1 2 3 4 5 6 7 8 10	3.552 3.647 3.742 3.836 3.928 4.024 4.119 4.213 4.431	3.743 3.838 3.933 4.027 4.119 4.215 4.310 4.404 4.622
	32530 FourCast® 2 Four, Fully upholstered	4.1	6		1 2 3 4 5 6 7 8 10	4.999 5.220 5.443 5.663 5.882 6.103 6.325 6.544 7.030	
	32600 FourCast® 2 Four with Armrests, Polypropylene shell	5.3	12		-	3.443	3.634

FourCast® 2 Four

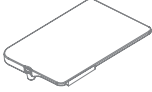
Design by Strand+Hvass

[Content ↗](#)

Product	Description (Item nr)	Weight (Kg)	Stacking on floor	Dimensions (mm)	Band	Standard PP (SEK)	Optional PP (SEK)
	32610 FourCast® 2 Four with Armrests, Seat pad	6.3	10		1	4.705	4.896
					2	4.800	4.991
					3	4.895	5.086
					4	4.989	5.180
					5	5.081	5.272
					6	5.177	5.368
					7	5.272	5.463
					8	5.366	5.557
					10	5.584	5.775
						32630 FourCast® 2 Four with Armrests, Fully upholstered	4.6
2	6.373						
3	6.596						
4	6.816						
5	7.035						
6	7.256						
7	7.478						
8	7.697						
10	8.183						
	32700 FourCast® 2 Four with Loop Armrests, Polypropylene shell	5.9	12				
	32710 FourCast® 2 Four with Loop Armrests, Seat pad	6.8	10		1	4.705	4.896
					2	4.800	4.991
					3	4.895	5.086
					4	4.989	5.180
					5	5.081	5.272
					6	5.177	5.368
					7	5.272	5.463
					8	5.366	5.557
					10	5.584	5.775
						32730 FourCast® 2 Four with Loop Armrests, Fully upholstered	5.2
2	6.373						
3	6.596						
4	6.816						
5	7.035						
6	7.256						
7	7.478						
8	7.697						
10	8.183						

ACCESSORIES	Description	Weight (Kg)	Dimensions (mm)	Price (SEK)
	CHAIR FEET Felt glides, set of 4 pcs. height + 0,2 cm	1,82 g x 4		208
	CHAIR FEET Set of 4 pcs. Noise reducing ferrule with big diameter (reduces pressure marks) Chair height + 0,8 cm	4,8 g x 4		276
	CHAIR FEET Noise reducing ferrule with felt, set of 4 pcs. Chair height + 1 cm	6,6 g x 4		276
	CHAIR FEET Teflon glides, set of 4 pcs. Chair height + 0,2 cm	2,75 g x 4		208
	LINKING DEVICE Chair linking	0,4 KG	C/C 535 mm C/C with armrest 585 mm C/C with Loop armrest 625 mm	417
	GRIP HOLE Available for chairs without inside – and full upholstery			189
	INNO Inno® Note in black, removable and foldable. Not available for chairs with Loop armrest and chairs with wooden legs.	1,4 KG	225 x 325 x 10 mm	1.522
	SEAT ROW NUMBER - ACSR0101 16 mm - no.1 -25	29 g		1.579
	SEAT ROW NUMBER - ACSR0102 16 mm - no.26 -50	29 g		1.579
	INNO@NOTE TROLLEY - 20100007 Trolley for Inno® Note. Room for 51 Inno® Notes.	58,5 Kg	1532 x 662 x 1199 mm	19.942
	CHAIR TROLLEY - 200X0 25 chairs without upholstery	33,5 Kg	1100 x 560 x 1970 mm	8.859
	CHAIR TROLLEY - 200X0 20 chairs with seat pad or 18 chairs with full upholstery	33,5 Kg	1100 x 560 x 1910 / 1980 mm	10.373
	SACK TROLLEY - 200X1 12 chairs without upholstery, 10 chairs with full upholstery			4.918

FourCast® 2 Four

Design by Strand+Hvass

[Content ↗](#)

SURCHARGE		Price (SEK)
FRAME OPTIONAL	 7 A D E F M N O Q S T	194

FourCast® 2 Four - Veneer

Design by Strand+Hvass

[Content ↗](#)



FEATURES

- Armrest options and wooden legs options*
- Linking device under seat options
- Monochrome powder coating on frames options
- Polyamide glides as standard
- Inno® Note tablet options
- Stackable on matching trolley
- We do not recommend suspensions to black lacquered versions



For product information visit oceefour.com ↗

SHELL COLOURS

Veneer



FRAME COLOURS



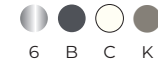



Standard

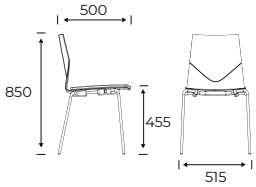

Frame optional*

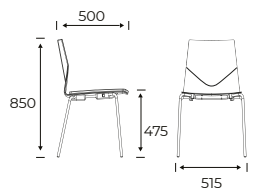

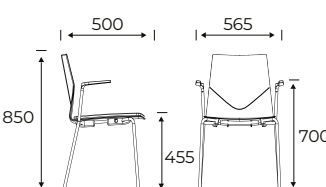

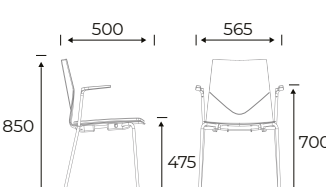
For full colour details [go to page 236](#) ↗

Product	Description (Item nr)	Weight (Kg)	Stacking on floor	Dimensions (mm)	Band	Veneer (SEK)
	32540 FourCast® 2 Four, Wooden shell	3.3	12		-	3.212
	32550 FourCast® 2 Four, Seat pad, wooden shell	4.8	10		1 2 3 4 5 6 7 8 10	4.474 4.569 4.664 4.758 4.850 4.946 5.041 5.135 5.353
	32640 FourCast® 2 Four with Armrests, Wooden shell	3.9	6		-	4.365
	32650 FourCast® 2 Four with Armrests, Seat pad, wooden shell	5.3	12		1 2 3 4 5 6 7 8 10	5.627 5.722 5.817 5.911 6.003 6.099 6.194 6.288 6.506

FourCast® 2 Four - Veneer

[Content ↗](#)

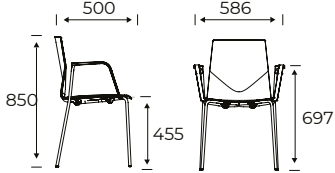

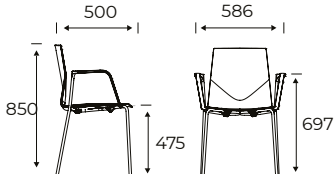





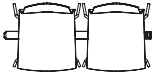

Design by Strand+Hvass

Product	Description (Item nr)	Weight (Kg)	Stacking on floor	Dimensions (mm)	Band	Veneer (SEK)
	32740 FourCast® 2 Four with Loop Armrests, Wooden shell	4.4	10		-	4.365
	32750 FourCast® 2 Four with Loop Armrests, Seat pad, wooden shell	5.8	6		1 2 3 4 5 6 7 8 10	5.627 5.722 5.817 5.911 6.003 6.099 6.194 6.288 6.506

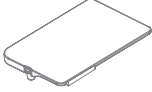
FourCast® 2 Four - Veneer

Design by Strand+Hvass



[Content ↗](#)

ACCESSORIES	Description	Weight (Kg)	Dimensions (mm)	Price (SEK)
	CHAIR FEET Felt glides, set of 4 pcs. height + 0,2 cm	1,82 g x 4		208
	CHAIR FEET Set of 4 pcs. Noise reducing ferrule with big diameter (reduces pressure marks) Chair height + 0,8 cm	4,8 g x 4		276
	CHAIR FEET Noise reducing ferrule with felt, set of 4 pcs. Chair height + 1 cm	6,6 g x 4		276
	CHAIR FEET Teflon glides, set of 4 pcs. Chair height + 0,2 cm	2,75 g x 4		208
	LINKING DEVICE Chair linking	0,4 KG	C/C 535 mm C/C with armrest 585 mm C/C with Loop armrest 625 mm	417
	GRIP HOLE Available for chairs without inside – and full upholstery			189
	INNO Inno® Note in black, removable and foldable. Not available for chairs with Loop armrest and chairs with wooden legs.	1,4 KG	225 x 325 x 10 mm	1.522
	SEAT ROW NUMBER - ACSR0101 16 mm - no.1 -25	29 g		1.579
	SEAT ROW NUMBER - ACSR0102 16 mm - no.26 -50	29 g		1.579
	INNO@NOTE TROLLEY - 20100007 Trolley for Inno® Note. Room for 51 Inno® Notes.	58,5 Kg	1532 x 662 x 1199 mm	19.942
	CHAIR TROLLEY - 200X0 25 chairs without upholstery	33,5 Kg	1100 x 560 x 1970 mm	8.859
	CHAIR TROLLEY - 200X0 20 chairs with seat pad or 18 chairs with full upholstery	33,5 Kg	1100 x 560 x 1910 / 1980 mm	10.373
	SACK TROLLEY - 200X1 12 chairs without upholstery, 10 chairs with full upholstery			4.918

FourCast® 2 Four - Veneer

Design by Strand+Hvass

[Content ↗](#)

SURCHARGE		Price (SEK)
FRAME OPTIONAL	 7 A D E F M N O Q S T	194
	 P	473

FourCast® 2 Line

Design by Strand+Hvass

[Content ↗](#)



FEATURES

- Armrest options
- Linking device optional on frames or under seat
- Monochrome powder coating on frames options
- Polyamide glides as standard
- Inno® Note tablet options
- Stackable on matching trolley
- Outdoor options
- We do not recommend suspensions for fully upholstered version



For product information visit oceefour.com ↗

SHELL COLOURS

Standard Polypropylene



FRAME COLOURS

Standard



Optional Polypropylene

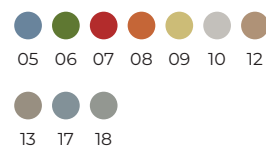

Frame optional*





For full colour details [go to page 236](#) ↗

Product	Description (Item nr)	Weight (Kg)	Stacking on floor	Dimensions (mm)	Band	Standard PP (SEK)	Optional PP (SEK)
	33200 FourCast® 2 Line, Polypropylene shell	5.7	12		-	2.776	2.967
	33210 FourCast® 2 Line, Seat pad	6.7	10		1 2 3 4 5 6 7 8 10	4.038 4.133 4.228 4.322 4.414 4.510 4.605 4.699 4.917	4.229 4.324 4.419 4.513 4.605 4.701 4.796 4.890 5.108
	33230 FourCast® 2 Line, Fully upholstered	5	8		1 2 3 4 5 6 7 8 10	5.485 5.706 5.929 6.149 6.368 6.589 6.811 7.030 7.516	
	33300 FourCast® 2 Line with Armrests, Polypropylene shell	6.5	12		-	3.715	3.906

FourCast® 2 Line

Design by Strand+Hvass

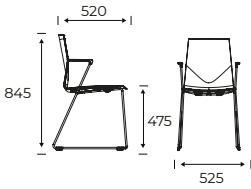







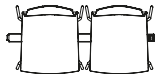

[Content ↗](#)

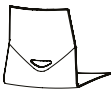
Product	Description (Item nr)	Weight (Kg)	Stacking on floor	Dimensions (mm)	Band	Standard PP (SEK)	Optional PP (SEK)
	33310 FourCast® 2 Line with Armrests, Seat pad	7.4	10		1	4.977	5.168
					2	5.072	5.263
					3	5.167	5.358
					4	5.261	5.452
					5	5.353	5.544
					6	5.449	5.640
					7	5.544	5.735
					8	5.638	5.829
					10	5.856	6.047
						33330 FourCast® 2 Line with Armrests, Fully upholstered	5.8
2	6.645						
3	6.868						
4	7.088						
5	7.307						
6	7.528						
7	7.750						
8	7.969						
10	8.455						

FourCast® 2 Line

Design by Strand+Hvass

[Content ↗](#)

ACCESSORIES	Description	Weight (Kg)	Dimensions (mm)	Price (SEK)
	CHAIR FEET Felt glides, set of 4 pcs. height + 0,2 cm	1,82 g x 4		208
	CHAIR FEET Teflon glides, set of 4 pcs. Chair height + 0,2 cm	2,75 g x 4		208
	LINKING DEVICE Chair linking	0,4 KG	C/C 535 mm C/C with armrest 585 mm C/C with Loop armrest 625 mm	417
	LINKING DEVICE Chair linking		C/C 540 mm C/C with armrest 540 mm	390
	GRIP HOLE Available for chairs without inside – and full upholstery			189
	INNO Inno® Note in black, removable and foldable. Not available for chairs with Loop armrest and chairs with wooden legs.	1,4 KG	225 x 325 x 10 mm	1.522
	SEAT ROW NUMBER - ACSR0201 11 mm - no. 1 -25	29 g		1.579
	SEAT ROW NUMBER - ACSR0202 11 mm - no. 26 -50	29 g		1.579
	INNO@NOTE TROLLEY - 20100007 Trolley for Inno® Note. Room for 51 Inno® Notes.	58,5 Kg	1532 x 662 x 1199 mm	19.942
	CHAIR TROLLEY - 200X0 30 chairs without upholstery	33,5 Kg	1100 x 560 x 1970 mm	8.859
	CHAIR TROLLEY - 200X0 19 chairs with seat pad or 20 chairs with full upholstery	33,5 Kg	1100 x 560 x 1910 / 1980 mm	10.373
	SACK TROLLEY - 200X1 12 chairs without upholstery, 10 chairs with full upholstery			4.918

SURCHARGE		Price (SEK)
FRAME OPTIONAL	 7 A D E F M N O Q S T	194

FourCast® 2 Line - Veneer

Design by Strand+Hvass

[Content ↗](#)



FEATURES

- Armrest options
- Linking device optional on frames or under seat
- Monochrome powder coating on frames options
- Polyamide glides as standard
- Inno® Note tablet options
- Stackable on matching trolley
- We do not recommend suspensions to black lacquered versions



For product information visit oceefour.com ↗

SHELL COLOURS

Veneer



FRAME COLOURS

Standard



Frame optional*











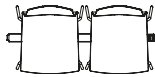

For full colour details [go to page 236](#) ↗

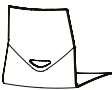
Product	Description (Item nr)	Weight (Kg)	Stacking on floor	Dimensions (mm)	Band	Veneer (SEK)
	33240 FourCast® 2 Line, Wooden shell	4.3	12		-	3.698
	33250 FourCast® 2 Line, Seat pad, wooden shell	5.6	10		1 2 3 4 5 6 7 8 10	4.960 5.055 5.150 5.244 5.336 5.432 5.527 5.621 5.839
	33340 FourCast® 2 Line with Armrests, Wooden shell	5	8		-	4.637
	33350 FourCast® 2 Line with Armrests, Seat pad, wooden shell	6.4	10		1 2 3 4 5 6 7 8 10	5.899 5.994 6.089 6.183 6.275 6.371 6.466 6.560 6.778

FourCast® 2 Line - Veneer

Design by Strand+Hvass

[Content ↗](#)

ACCESSORIES	Description	Weight (Kg)	Dimensions (mm)	Price (SEK)
	CHAIR FEET Felt glides, set of 4 pcs. height + 0,2 cm	1,82 g x 4		208
	CHAIR FEET Teflon glides, set of 4 pcs. Chair height + 0,2 cm	2,75 g x 4		208
	LINKING DEVICE Chair linking	0,4 KG	C/C 535 mm C/C with armrest 585 mm C/C with Loop armrest 625 mm	417
	LINKING DEVICE Chair linking		C/C 540 mm C/C with armrest 540 mm	390
	GRIP HOLE Available for chairs without inside - and full upholstery			189
	INNO Inno® Note in black, removable and foldable. Not available for chairs with Loop armrest and chairs with wooden legs.	1,4 KG	225 x 325 x 10 mm	1.522
	SEAT ROW NUMBER - ACSR0201 11 mm - no. 1 -25	29 g		1.579
	SEAT ROW NUMBER - ACSR0202 11 mm - no. 26 -50	29 g		1.579
	INNO@NOTE TROLLEY - 20100007 Trolley for Inno® Note. Room for 51 Inno® Notes.	58,5 Kg	1532 x 662 x 1199 mm	19.942
	CHAIR TROLLEY - 200X0 30 chairs without upholstery	33,5 Kg	1100 x 560 x 1970 mm	8.859
	CHAIR TROLLEY - 200X0 19 chairs with seat pad or 20 chairs with full upholstery	33,5 Kg	1100 x 560 x 1910 / 1980 mm	10.373
	SACK TROLLEY - 200X1 12 chairs without upholstery, 10 chairs with full upholstery			4.918

SURCHARGE		Price (SEK)
FRAME OPTIONAL	 7 A D E F M N O Q S T	194

FourCast® 2 Counter

Design by Strand+Hvass

[Content ↗](#)



FEATURES

- Fits table height 90 cm
- Stackable on floor
- Polyamide glides as standard
- Monochrome powder coating on frames options
- Outdoor options
- We do not recommend suspensions to fully upholstered version



For product information visit oceefour.com ↗

SHELL COLOURS

Standard Polypropylene



FRAME COLOURS

Standard



Optional Polypropylene

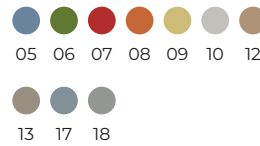

Frame optional*



For full colour details [go to page 236](#) ↗

Product	Description (Item nr)	Weight (Kg)	Stacking on floor	Dimensions (mm)	Band	Standard PP (SEK)	Optional PP (SEK)
	33800 FourCast® 2 Counter, Polypropylene shell	6.6	4		-	3.730	3.921
	33810 FourCast® 2 Counter, Seat pad	7.5	4		1 2 3 4 5 6 7 8 10	4.992 5.087 5.182 5.276 5.368 5.464 5.559 5.653 5.871	5.183 5.278 5.373 5.467 5.559 5.655 5.750 5.844 6.062
	33830 FourCast® 2 Counter, Fully upholstered	7.1	4		1 2 3 4 5 6 7 8 10	6.439 6.660 6.883 7.103 7.322 7.543 7.765 7.984 8.470	

FourCast® 2 Counter

Design by Strand+Hvass

[Content ↗](#)

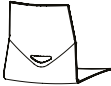
ACCESSORIES	Description	Weight (Kg)	Dimensions (mm)	Price (SEK)
	CHAIR FEET Felt glides, set of 4 pcs. height + 0,2 cm	1,82 g x 4		208
	CHAIR FEET Teflon glides, set of 4 pcs. Chair height + 0,2 cm	2,75 g x 4		208
	GRIP HOLE Available for chairs without inside – and full upholstery			189

SURCHARGE		Price (SEK)
FRAME OPTIONAL	 7 A D E F M N O Q S T	194

FourCast® 2 Counter - Veneer

Design by Strand+Hvass

[Content](#) ↗



FEATURES

- Fits table height 90 cm
- Stackable on floor
- Polyamide glides as standard
- Monochrome powder coating on frames options
- We do not recommend suspensions to black lacquered versions

For product information visit oceefour.com ↗

SHELL COLOURS

Veneer



FRAME COLOURS



Standard



Frame optional*

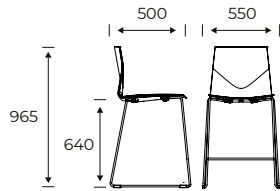

For full colour details [go to page 236](#) ↗

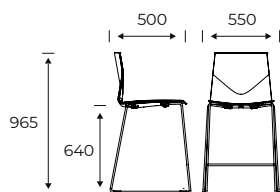
Product	Description (Item nr)	Weight (Kg)	Stacking on floor	Dimensions (mm)	Band	Veneer (SEK)
	33840 FourCast® 2 Counter, Wooden shell	7.2	4		-	4.652
	33850 FourCast® 2 Counter, Seat pad, wooden shell	8.6	4		1 2 3 4 5 6 7 8 10	5.914 6.009 6.104 6.198 6.290 6.386 6.481 6.575 6.793

ACCESSORIES	Description	Weight (Kg)	Dimensions (mm)	Price (SEK)
	CHAIR FEET Felt glides, set of 4 pcs. height + 0,2 cm	1,82 g x 4		208
	CHAIR FEET Teflon glides, set of 4 pcs. Chair height + 0,2 cm	2,75 g x 4		208
	GRIP HOLE Available for chairs without inside - and full upholstery			189

FourCast® 2 Counter - Veneer

Design by Strand+Hvass

[Content ↗](#)

SURCHARGE		Price (SEK)
FRAME OPTIONAL	 7 A D E F M N O Q S T	194

FourCast® 2 High

Design by Strand+Hvass

[Content ↗](#)



FEATURES

- Fits table height 105 cm
- Stackable on floor
- Polyamide glides as standard
- Monochrome powder coating on frames options
- Outdoor options
- We do not recommend suspensions to fully upholstered version



For product information visit oceefour.com ↗

SHELL COLOURS

Standard Polypropylene



Optional Polypropylene

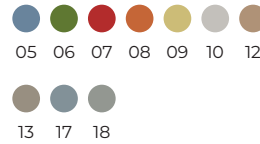

FRAME COLOURS

Standard



Frame optional*



For full colour details [go to page 236](#) ↗

Product	Description (Item nr)	Weight (Kg)	Stacking on floor	Dimensions (mm)	Band	Standard PP (SEK)	Optional PP (SEK)
	33900 FourCast® 2 High, Polypropylene shell	7.3	4		-	3.815	4.006
	33910 FourCast® 2 High, Seat pad	8.3	4		1 2 3 4 5 6 7 8 10	5.077 5.172 5.267 5.361 5.453 5.549 5.644 5.738 5.956	5.268 5.363 5.458 5.552 5.644 5.740 5.835 5.929 6.147
	33930 FourCast® 2 High, Fully upholstered	7.8	4		1 2 3 4 5 6 7 8 10	6.524 6.745 6.968 7.188 7.407 7.628 7.850 8.069 8.555	

FourCast® 2 High

Design by Strand+Hvass

[Content ↗](#)

ACCESSORIES	Description	Weight (Kg)	Dimensions (mm)	Price (SEK)
	CHAIR FEET Felt glides, set of 4 pcs. height + 0,2 cm	1,82 g x 4		208
	CHAIR FEET Teflon glides, set of 4 pcs. Chair height + 0,2 cm	2,75 g x 4		208
	GRIP HOLE Available for chairs without inside – and full upholstery			189

SURCHARGE		Price (SEK)
FRAME OPTIONAL	 7 A D E F M N O Q S T	194

FourCast® 2 High - Veneer

Design by Strand+Hvass

[Content](#) ↗



FEATURES

- Fits table height 105 cm
- Stackable on floor
- Polyamide glides as standard
- Monochrome powder coating on frames options
- We do not recommend suspensions to black lacquered versions



For product information visit oceefour.com ↗

SHELL COLOURS

Veneer



FRAME COLOURS

Standard



Frame optional*



For full colour details [go to page 236](#) ↗

Product	Description (Item nr)	Weight (Kg)	Stacking on floor	Dimensions (mm)	Band	Veneer (SEK)
	33940 FourCast® 2 High, Wooden shell	8	4		-	4.737
	33950 FourCast® 2 High, Seat pad, wooden shell	9.4	4		1 2 3 4 5 6 7 8 10	5.999 6.094 6.189 6.283 6.375 6.471 6.566 6.660 6.878

ACCESSORIES	Description	Weight (Kg)	Dimensions (mm)	Price (SEK)
	CHAIR FEET Felt glides, set of 4 pcs. height + 0,2 cm	1,82 g x 4		208
	CHAIR FEET Teflon glides, set of 4 pcs. Chair height + 0,2 cm	2,75 g x 4		208
	GRIP HOLE Available for chairs without inside - and full upholstery			189

FourCast® 2 High - Veneer

Design by Strand+Hvass

[Content ↗](#)

SURCHARGE		Price (SEK)
FRAME OPTIONAL	 7 A D E F M N O Q S T	194

FourCast® 2 Counter Four

Design by Strand+Hvass

[Content ↗](#)



FEATURES

- Fits table height 90 cm
- Stackable on floor
- Polyamide glides as standard
- Monochrome powder coating on frames options
- We do not recommend suspensions to fully upholstered version



For product information visit oceefour.com ↗

SHELL COLOURS

Standard Polypropylene



FRAME COLOURS

Standard



Optional Polypropylene

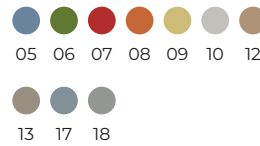

Frame optional*



For full colour details [go to page 236](#) ↗

Product	Description (Item nr)	Weight (Kg)	Stacking on floor	Dimensions (mm)	Band	Standard PP (SEK)	Optional PP (SEK)
	34000 FourCast® 2 Counter Four, Polypropylene shell	7.7	4		-	3.492	3.683
	34010 FourCast® 2 Counter Four, Seat pad	8.6	4		1 2 3 4 5 6 7 8 10	4.754 4.849 4.944 5.038 5.130 5.226 5.321 5.415 5.633	4.945 5.040 5.135 5.229 5.321 5.417 5.512 5.606 5.824
	34030 FourCast® 2 Counter Four, Fully upholstered	8.2	4		1 2 3 4 5 6 7 8 10	6.201 6.422 6.645 6.865 7.084 7.305 7.527 7.746 8.232	

FourCast® 2 Counter Four

Design by Strand+Hvass

[Content ↗](#)

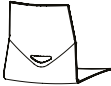
ACCESSORIES	Description	Weight (Kg)	Dimensions (mm)	Price (SEK)
	CHAIR FEET Felt glides, set of 4 pcs. height + 0,2 cm	1,82 g x 4		208
	CHAIR FEET Teflon glides, set of 4 pcs. Chair height + 0,2 cm	2,75 g x 4		208
	GRIP HOLE Available for chairs without inside – and full upholstery			189

SURCHARGE		Price (SEK)
FRAME OPTIONAL	 7 A D E F M N O Q S T	194

FourCast® 2 Counter Four - Veneer

Design by Strand+Hvass

[Content](#) ↗



FEATURES

- Fits table height 90 cm
- Stackable on floor
- Polyamide glides as standard
- Monochrome powder coating on frames options
- We do not recommend suspensions to black lacquered versions



For product information visit oceefour.com ↗

SHELL COLOURS

Veneer



FRAME COLOURS

Standard



Frame optional*



For full colour details [go to page 236](#) ↗

Product	Description (Item nr)	Weight (Kg)	Stacking on floor	Dimensions (mm)	Band	Veneer (SEK)
	34040 FourCast® 2 Counter Four, Wooden shell	8.3	4		-	4.414
	34050 FourCast® 2 Counter Four, Seat pad, wooden shell	9.7	4		1 2 3 4 5 6 7 8 10	5.676 5.771 5.866 5.960 6.052 6.148 6.243 6.337 6.555

ACCESSORIES	Description	Weight (Kg)	Dimensions (mm)	Price (SEK)
	CHAIR FEET Felt glides, set of 4 pcs. height + 0,2 cm	1,82 g x 4		208
	CHAIR FEET Teflon glides, set of 4 pcs. Chair height + 0,2 cm	2,75 g x 4		208
	GRIP HOLE Available for chairs without inside - and full upholstery			189

FourCast® 2 Counter Four - Veneer

Design by Strand+Hvass

[Content ↗](#)

SURCHARGE		Price (SEK)
FRAME OPTIONAL	 7 A D E F M N O Q S T	194

FourCast® 2 High Four

Design by Strand+Hvass

[Content ↗](#)



FEATURES

- Fits table height 105 cm
- Stackable on floor
- Polyamide glides as standard
- Monochrome powder coating on frames options
- We do not recommend suspensions to fully upholstered version



For product information visit oceefour.com ↗

SHELL COLOURS

Standard Polypropylene



Optional Polypropylene

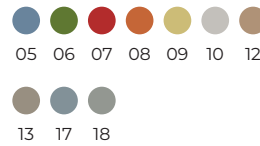

FRAME COLOURS

Standard



Frame optional*





For full colour details [go to page 236](#) ↗

Product	Description (Item nr)	Weight (Kg)	Stacking on floor	Dimensions (mm)	Band	Standard PP (SEK)	Optional PP (SEK)
	34100 FourCast® 2 High Four, Polypropylene shell	6.7	4		-	3.492	3.683
	34110 FourCast® 2 High Four, Seat pad	7.7	4		1 2 3 4 5 6 7 8 10	4.754 4.849 4.944 5.038 5.130 5.226 5.321 5.415 5.633	4.945 5.040 5.135 5.229 5.321 5.417 5.512 5.606 5.824
	34130 FourCast® 2 High Four, Fully upholstered	7.2	4		1 2 3 4 5 6 7 8 10	6.201 6.422 6.645 6.865 7.084 7.305 7.527 7.746 8.232	

FourCast® 2 High Four

Design by Strand+Hvass

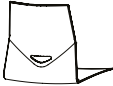
[Content ↗](#)

ACCESSORIES	Description	Weight (Kg)	Dimensions (mm)	Price (SEK)
	CHAIR FEET Felt glides, set of 4 pcs. height + 0,2 cm	1,82 g x 4		208
	CHAIR FEET Teflon glides, set of 4 pcs. Chair height + 0,2 cm	2,75 g x 4		208
	GRIP HOLE Available for chairs without inside – and full upholstery			189
SURCHARGE				Price (SEK)
FRAME OPTIONAL	 7 A D E F M N O Q S T			194

FourCast® 2 High Four - Veneer

Design by Strand+Hvass

[Content](#) ↗



FEATURES

- Fits table height 105 cm
- Stackable on floor
- Polyamide glides as standard
- Monochrome powder coating on frames options
- We do not recommend suspensions to black lacquered versions

For product information visit oceefour.com ↗

SHELL COLOURS

Veneer



FRAME COLOURS

Standard



Frame optional*



For full colour details [go to page 236](#) ↗

Product	Description (Item nr)	Weight (Kg)	Stacking on floor	Dimensions (mm)	Band	Veneer (SEK)
	34140 FourCast® 2 High Four, Wooden shell	7.4	4		-	4.414
	34150 FourCast® 2 High Four, Seat pad, wooden shell	8.8	4		1 2 3 4 5 6 7 8 10	5.676 5.771 5.866 5.960 6.052 6.148 6.243 6.337 6.555

ACCESSORIES	Description	Weight (Kg)	Dimensions (mm)	Price (SEK)
	CHAIR FEET Felt glides, set of 4 pcs. height + 0,2 cm	1,82 g x 4		208
	CHAIR FEET Teflon glides, set of 4 pcs. Chair height + 0,2 cm	2,75 g x 4		208
	GRIP HOLE Available for chairs without inside - and full upholstery			189

FourCast® 2 High Four - Veneer

Design by Strand+Hvass

[Content ↗](#)

SURCHARGE		Price (SEK)
FRAME OPTIONAL	 <p>7 A D E F M N O Q S T</p>	194

FourCast® 2 Wheeler

Design by Strand+Hvass

[Content ↗](#)



FEATURES

- Inno® Tab, flexible and rotating writing tablet options
- Gas lift, 41 - 57,5 cm
- Free Float options
- Black base with castors as standard
- Aluminium base options
- We do not recommend suspensions to fully upholstered version



For product information visit oceefour.com ↗

SHELL COLOURS

Standard Polypropylene



Optional Polypropylene



FRAME COLOURS

Standard



Frame optional*









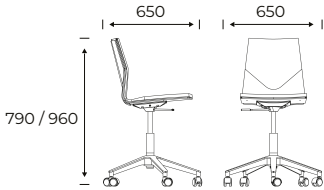

For full colour details [go to page 236](#) ↗

Product	Description (Item nr)	Weight (Kg)	Dimensions (mm)	Band	Standard PP (SEK)	Optional PP (SEK)
	35004 FourCast® 2 Wheeler, Polypropylene shell, Without tilt with gas	7.3		-	3.016	3.207
	35014 FourCast® 2 Wheeler, Seat pad, Without tilt with gas	7.9		1 2 3 4 5 6 7 8 10	4.278 4.373 4.468 4.562 4.654 4.750 4.845 4.939 5.157	4.469 4.564 4.659 4.753 4.845 4.941 5.036 5.130 5.348
	35034 FourCast® 2 Wheeler, Fully upholstered, Without tilt with gas	6.2		1 2 3 4 5 6 7 8 10	5.725 5.946 6.169 6.389 6.608 6.829 7.051 7.270 7.756	
	35005 FourCast® 2 Wheeler, Polypropylene shell, With tilt with gas	7.3		-	3.380	3.571

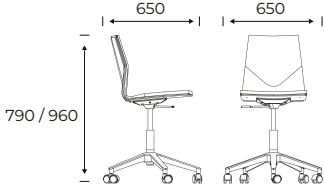
FourCast® 2 Wheeler

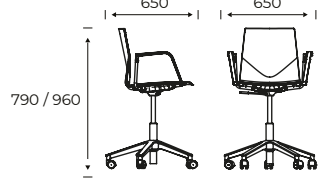
Design by Strand+Hvass

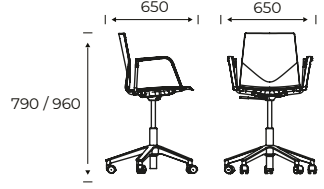

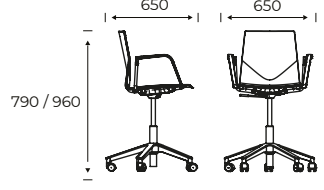

[Content ↗](#)

Product	Description (Item nr)	Weight (Kg)	Dimensions (mm)	Band	Standard PP (SEK)	Optional PP (SEK)
	35015 FourCast® 2 Wheeler, Seat pad, With tilt with gas	7.9		1 2 3 4 5 6 7 8 10	4.642 4.737 4.832 4.926 5.018 5.114 5.209 5.303 5.521	4.833 4.928 5.023 5.117 5.209 5.305 5.400 5.494 5.712
	35035 FourCast® 2 Wheeler, Fully upholstered, With tilt with gas	6.2		1 2 3 4 5 6 7 8 10	6.089 6.310 6.533 6.753 6.972 7.193 7.415 7.634 8.120	
	34905 FourCast® 2 Wheeler with Loop Armrests, Polypropylene shell, With tilt with gas	8.5		-	4.524	4.715
	34915 FourCast® 2 Wheeler with Loop Armrests, Seat pad, With tilt with gas	9.1		1 2 3 4 5 6 7 8 10	5.786 5.881 5.976 6.070 6.162 6.258 6.353 6.447 6.665	5.977 6.072 6.167 6.261 6.353 6.449 6.544 6.638 6.856
	34935 FourCast® 2 Wheeler with Loop Armrests, Fully upholstered, With tilt with gas	7.4		1 2 3 4 5 6 7 8 10	7.233 7.454 7.677 7.897 8.116 8.337 8.559 8.778 9.264	

FourCast® 2 Wheeler

Design by Strand+Hvass

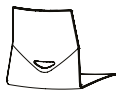
[Content ↗](#)

ACCESSORIES	Description	Weight (Kg)	Dimensions (mm)	Price (SEK)
	HOOK Hook in black			47
	CHAIR FEET Standard polymide glides. Chair height + 0,2 cm			
	CHAIR FEET Castor with breaks, hard			599
	FOOTRING Gas lift including footring Spand 41 cm. - 57,5 cm.		585 - 845 mm	1.368
	GRIP HOLE Available for chairs without inside - and full upholstery			189
	With GS certification			1.489
	INNO Foldable Inno® Tab in black with integrated cup holder and dashboard for tablet and phone.	2,7 KG	520 x 320 x 23 mm	2.125
SURCHARGE				Price (SEK)
FRAME OPTIONAL	 4			643

FourCast® 2 77

Design by Strand+Hvass

[Content ↗](#)



FEATURES

- Armrest options
- Stackable on floor
- Monochrome powder coating on frames options
- We do not recommend suspensions for fully upholstered version



For product information visit oceefour.com ↗

SHELL COLOURS

Standard Polypropylene



FRAME COLOURS

Standard



Optional Polypropylene

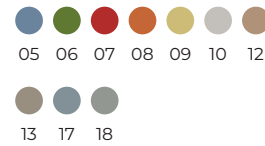

Frame optional*





For full colour details [go to page 236](#) ↗

Product	Description (Item nr)	Weight (Kg)	Stacking on floor	Dimensions (mm)	Band	Standard PP (SEK)	Optional PP (SEK)
	32800 FourCast® 2 77, Polypropylene shell	5.8	7		-	2.734	2.925
	32810 FourCast® 2 77, Seat pad	6.8	5		1 2 3 4 5 6 7 8 10	3.996 4.091 4.186 4.280 4.372 4.468 4.563 4.657 4.875	4.187 4.282 4.377 4.471 4.563 4.659 4.754 4.848 5.066
	32830 FourCast® 2 77, Fully upholstered	5.1	5		1 2 3 4 5 6 7 8 10	5.443 5.664 5.887 6.107 6.326 6.547 6.769 6.988 7.474	
	32900 FourCast® 2 77 with Armrests, Polypropylene shell	6.4	7		-	3.888	4.079

FourCast® 2 77

Design by Strand+Hvass

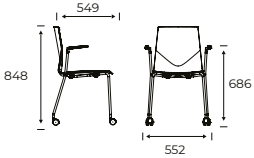
[Content ↗](#)

Product	Description (Item nr)	Weight (Kg)	Stacking on floor	Dimensions (mm)	Band	Standard PP (SEK)	Optional PP (SEK)
	32910 FourCast® 2 77 with Armrests, Seat pad	7.4	5		1	5.150	5.341
					2	5.245	5.436
					3	5.340	5.531
					4	5.434	5.625
					5	5.526	5.717
					6	5.622	5.813
					7	5.717	5.908
					8	5.811	6.002
					10	6.029	6.220
						32930 FourCast® 2 77 with Armrests, Fully upholstered	5.8
2	6.818						
3	7.041						
4	7.261						
5	7.480						
6	7.701						
7	7.923						
8	8.142						
10	8.628						

ACCESSORIES	Description	Weight (Kg)	Dimensions (mm)	Price (SEK)
	GRIP HOLE Available for chairs without inside – and full upholstery			189

SURCHARGE		Price (SEK)
FRAME OPTIONAL	 7 A D E F M N O Q S T	194

FourCast® 2 77 - Veneer

Design by Strand+Hvass

[Content ↗](#)



FEATURES

- Armrest options
- Stackable on floor
- Monochrome powder coating on frames options
- We do not recommend suspensions to black lacquered versions



For product information visit oceefour.com ↗

SHELL COLOURS

Veneer



FRAME COLOURS







Standard

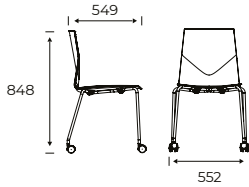

Frame optional*

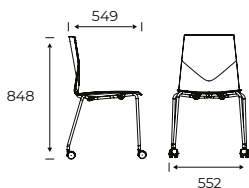

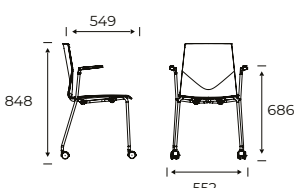

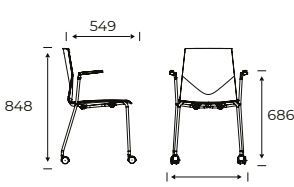
For full colour details [go to page 236](#) ↗

Product	Description (Item nr)	Weight (Kg)	Stacking on floor	Dimensions (mm)	Band	Veneer (SEK)
	32840 FourCast® 2 77, Wooden shell	4.4	-		-	3.656
	32850 FourCast® 2 77, Seat pad, wooden shell	5.8	5		1 2 3 4 5 6 7 8 10	4.918 5.013 5.108 5.202 5.294 5.390 5.485 5.579 5.797
	32940 FourCast® 2 77 with Armrests, Wooden shell	5	7		-	4.810
	32950 FourCast® 2 77 with Armrests, Seat pad, wooden shell	6.4	5		1 2 3 4 5 6 7 8 10	6.072 6.167 6.262 6.356 6.448 6.544 6.639 6.733 6.951

FourCast® 2 77 - Veneer

Design by Strand+Hvass

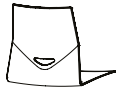
[Content ↗](#)

ACCESSORIES	Description	Weight (Kg)	Dimensions (mm)	Price (SEK)
	GRIP HOLE Available for chairs without inside – and full upholstery			189
SURCHARGE				Price (SEK)
FRAME OPTIONAL	 7 A D E F M N O Q S T			194

FourCast® 2 One

Design by Strand+Hvass

[Content ↗](#)



FEATURES

- Armrest options
- Swivel with freefloat in seat/back
- Return mechanism options
- Polyamide glides as standard
- Teflon or felt glides options
- Soft castor options (fixed cone without swivel and return)
- Monochrome powder coating on frames options
- We do not recommend suspensions to fully upholstered version



For product information visit oceefour.com ↗

SHELL COLOURS

Standard Polypropylene



FRAME COLOURS

Standard



Optional Polypropylene

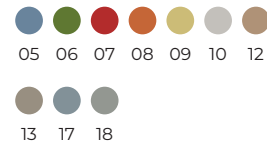











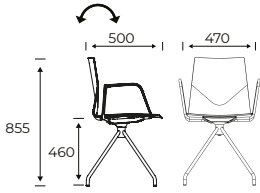

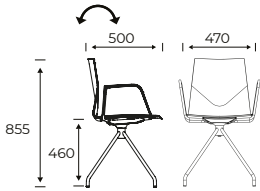

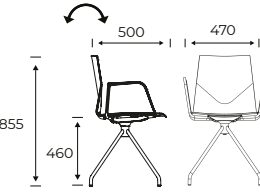
For full colour details [go to page 236](#) ↗

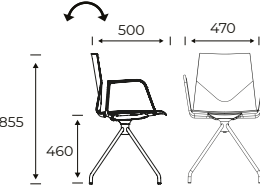

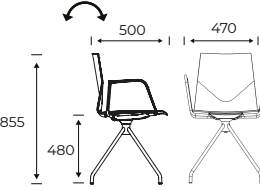
Product	Description (Item nr)	Weight (Kg)	Dimensions (mm)	Band	Standard PP (SEK)	Optional PP (SEK)
	33001 FourCast® 2 One, Polypropylene shell, With tilt	6.2		-	3.798	3.989
	33003 FourCast® 2 One, Polypropylene shell, With tilt with return	-		-	4.971	5.162
	33011 FourCast® 2 One, Seat pad, With tilt	6.8		1 2 3 4 5 6 7 8 10	5.060 5.155 5.250 5.344 5.436 5.532 5.627 5.721 5.939	5.251 5.346 5.441 5.535 5.627 5.723 5.818 5.912 6.130
	33013 FourCast® 2 One, Seat pad, With tilt with return	7		1 2 3 4 5 6 7 8 10	6.233 6.328 6.423 6.517 6.609 6.705 6.800 6.894 7.112	6.424 6.519 6.614 6.708 6.800 6.896 6.991 7.085 7.303

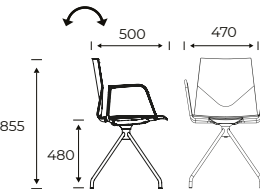
FourCast® 2 One

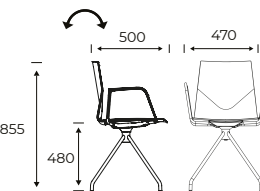
Design by Strand+Hvass

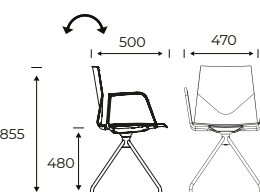
[Content ↗](#)

Product	Description (Item nr)	Weight (Kg)	Dimensions (mm)	Band	Standard PP (SEK)	Optional PP (SEK)
	33031 FourCast® 2 One, Fully upholstered, With tilt	5.1		1 2 3 4 5 6 7 8 10	6.507 6.728 6.951 7.171 7.390 7.611 7.833 8.052 8.538	
	33033 FourCast® 2 One, Fully upholstered, With tilt with return	5.3		1 2 3 4 5 6 7 8 10	7.680 7.901 8.124 8.344 8.563 8.784 9.006 9.225 9.711	
	33101 FourCast® 2 One with Loop Armrests, Polypropylene shell, With tilt	7.6		-	4.951	5.142
	33103 FourCast® 2 One with Loop Armrests, Polypropylene shell, With tilt with return	-		-	6.124	6.315
	33111 FourCast® 2 One with Loop Armrests, Seat pad, With tilt	7.9		1 2 3 4 5 6 7 8 10	6.213 6.308 6.403 6.497 6.589 6.685 6.780 6.874 7.092	6.404 6.499 6.594 6.688 6.780 6.876 6.971 7.065 7.283
	33113 FourCast® 2 One with Loop Armrests, Seat pad, With tilt with return	8.2		1 2 3 4 5 6 7 8 10	7.386 7.481 7.576 7.670 7.762 7.858 7.953 8.047 8.265	7.577 7.672 7.767 7.861 7.953 8.049 8.144 8.238 8.456
	33131 FourCast® 2 One with Loop Armrests, Fully upholstered, With tilt	6.3		1 2 3 4 5 6 7 8 10	7.660 7.881 8.104 8.324 8.543 8.764 8.986 9.205 9.691	
	33133 FourCast® 2 One with Loop Armrests, Fully upholstered, With tilt with return	6.5		1 2 3 4 5 6 7 8 10	8.833 9.054 9.277 9.497 9.716 9.937 10.159 10.378 10.864	

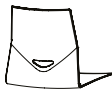
ACCESSORIES	Description	Weight (Kg)	Dimensions (mm)	Price (SEK)
	CHAIR FEET Castors			876
	CHAIR FEET Felt glides, set of 4 pcs. height + 0,2 cm	1,82 g x 4		208
	CHAIR FEET Set of 4 pcs. Noise reducing ferrule with big diameter (reduces pressure marks) Chair height + 0,8 cm	4,8 g x 4		276
	CHAIR FEET Noise reducing ferrule with felt, set of 4 pcs. Chair height + 1 cm	6,6 g x 4		276
	CHAIR FEET Teflon glides, set of 4 pcs. Chair height + 0,2 cm	2,75 g x 4		208
	GRIP HOLE Available for chairs without inside – and full upholstery			189

FourCast® 2 One - Veneer

Design by Strand+Hvass

[Content ↗](#)



FEATURES

- Armrest options
- Swivel with freefloat in seat/back
- Return mechanism options
- Polyamide glides as standard
- Teflon or felt glides and soft castor options
- We do not recommend suspensions to black lacquered versions



For product information visit oceefour.com ↗

SHELL COLOURS

Veneer







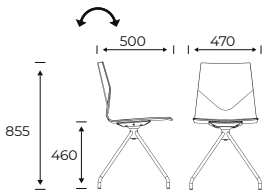

FRAME COLOURS

Standard

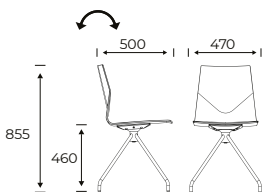

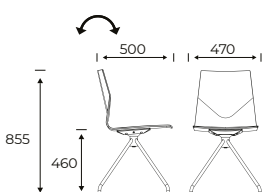

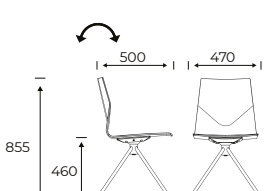



For full colour details [go to page 236](#) ↗

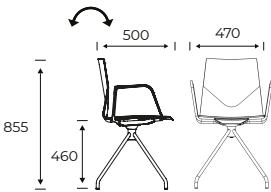

Product	Description (Item nr)	Weight (Kg)	Dimensions (mm)	Band	Veneer (SEK)	Optional PP (SEK)
	33041 FourCast® 2 One, Wooden shell, With tilt	4.7		-	4.720	4.720
	33043 FourCast® 2 One, Wooden shell, With tilt with return	5		-	5.893	5.893
	33051 FourCast® 2 One, Seat pad, wooden shell, With tilt	5.8		1 2 3 4 5 6 7 8 10	5.982 6.077 6.172 6.266 6.358 6.454 6.549 6.643 6.861	5.982 6.077 6.172 6.266 6.358 6.454 6.549 6.643 6.861
	33053 FourCast® 2 One, Seat pad, wooden shell, With tilt with return	5.9		1 2 3 4 5 6 7 8 10	7.155 7.250 7.345 7.439 7.531 7.627 7.722 7.816 8.034	7.155 7.250 7.345 7.439 7.531 7.627 7.722 7.816 8.034

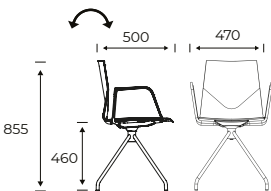
FourCast® 2 One - Veneer

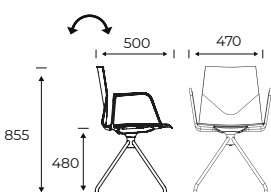
Design by Strand+Hvass

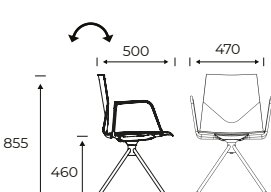
[Content ↗](#)

Product	Description (Item nr)	Weight (Kg)	Dimensions (mm)	Band	Veneer (SEK)	Optional PP (SEK)
	33141 FourCast® 2 One with Loop Armrests, Wooden shell, With tilt	5.9		-	5.873	5.873
	33143 FourCast® 2 One with Loop Armrests, Wooden shell, With tilt with return	6.1		-	7.046	7.046
	33151 FourCast® 2 One with Loop Armrests, Seat pad, wooden shell, With tilt	6.9		1 2 3 4 5 6 7 8 10	7.135 7.230 7.325 7.419 7.511 7.607 7.702 7.796 8.014	7.135 7.230 7.325 7.419 7.511 7.607 7.702 7.796 8.014
	33153 FourCast® 2 One with Loop Armrests, Seat pad, wooden shell, With tilt with return	7.1		1 2 3 4 5 6 7 8 10	8.308 8.403 8.498 8.592 8.684 8.780 8.875 8.969 9.187	8.308 8.403 8.498 8.592 8.684 8.780 8.875 8.969 9.187

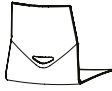
ACCESSORIES	Description	Weight (Kg)	Dimensions (mm)	Price (SEK)
	CHAIR FEET Castors			876
	CHAIR FEET Felt glides, set of 4 pcs. height + 0,2 cm	1,82 g x 4		208
	CHAIR FEET Set of 4 pcs. Noise reducing ferrule with big diameter (reduces pressure marks) Chair height + 0,8 cm	4,8 g x 4		276
	CHAIR FEET Noise reducing ferrule with felt, set of 4 pcs. Chair height + 1 cm	6,6 g x 4		276
	CHAIR FEET Teflon glides, set of 4 pcs. Chair height + 0,2 cm	2,75 g x 4		208
	GRIP HOLE Available for chairs without inside - and full upholstery			189



FourCast® 2 Fire Retardant

Design by Strand+Hvass

[Content ↗](#)



FEATURES

- Shell in Polypropylene
- Polyamide glides are standard
- Linking device optional for model 33200 only
- Stackable on matching trollies



For product information visit oceefour.com ↗

SHELL COLOURS

Standard Polypropylene



FRAME COLOURS

Standard











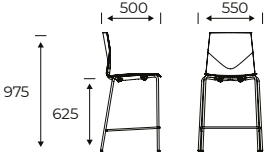

For full colour details [go to page 236](#) ↗

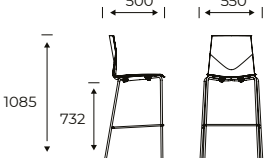
Product	Description (Item nr)	Weight (Kg)	Stacking on floor	Dimensions (mm)	Band	Standard PP (SEK)
	32500 FourCast@ 2 Four, Polypropylene shell	4.8	-		-	2.944
	33200 FourCast@ 2 Line, Polypropylene shell	5.7	-		-	3.430
	33800 FourCast@ 2 Counter, Polypropylene shell	6.6	-		-	4.384
	33900 FourCast@ 2 High, Polypropylene shell	7.3	-		-	4.469

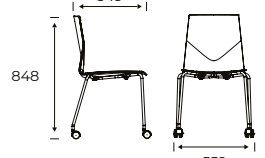
FourCast® 2 Fire Retardant

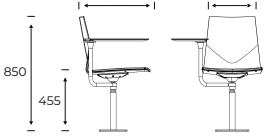
[Content ↗](#)

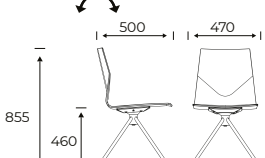

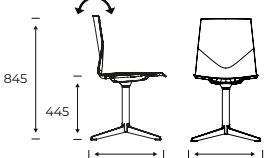





Design by Strand+Hvass

Product	Description (Item nr)	Weight (Kg)	Stacking on floor	Dimensions (mm)	Band	Standard PP (SEK)
	34000 FourCast@ 2 Counter Four, Polypropylene shell	7.7	-		-	4.146
	34100 FourCast@ 2 High Four, Polypropylene shell	6.7	-		-	4.146
	32800 FourCast@ 2 77, Polypropylene shell	5.8	-		-	3.388
	37001 FourCast@ 2 Audi, Polypropylene shell, With tilt	11.8	-		-	8.334
	33001 FourCast@ 2 One, Polypropylene shell, With tilt	6.2	-		-	4.452
	34503 FourCast@ 2 Evo, Polypropylene shell, With tilt with return	7	-		-	7.092

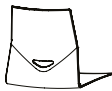
FourCast® 2 Fire Retardant

Design by Strand+Hvass

[Content ↗](#)

ACCESSORIES	Description	Weight (Kg)	Dimensions (mm)	Price (SEK)
	CHAIR FEET Felt glides, set of 4 pcs. height + 0,2 cm	1,82 g x 4		208
	CHAIR FEET Set of 4 pcs. Noise reducing ferrule with big diameter (reduces pressure marks) Chair height + 0,8 cm	4,8 g x 4		276
	CHAIR FEET Noise reducing ferrule with felt, set of 4 pcs. Chair height + 1 cm	6,6 g x 4		276
	CHAIR FEET Teflon glides, set of 4 pcs. Chair height + 0,2 cm	2,75 g x 4		208
	LINKING DEVICE Chair linking		C/C 540 mm C/C with armrest 540 mm	390
	GRIP HOLE Available for chairs without inside - and full upholstery			189
	SEAT ROW NUMBER - ACSR0101 16 mm - no. 1 -25	29 g		1.579
	SEAT ROW NUMBER - ACSR0102 16 mm - no. 26 -50	29 g		1.579
	SEAT ROW NUMBER - ACSR0201 11 mm - no. 1 -25	29 g		1.579
	SEAT ROW NUMBER - ACSR0202 11 mm - no. 26 -50	29 g		1.579
	CHAIR TROLLEY - 200X0 25 chairs without upholstery	33,5 Kg	1100 x 560 x 1970 mm	8.859
	INNO@NOTE TROLLEY - 20100007 Trolley for Inno® Note. Room for 51 Inno® Notes.	58,5 Kg	1532 x 662 x 1199 mm	19.942

[page 325](#)





FEATURES

- Wooden legs options*
- Polyamide glides as standard
- Powder coated frame options
- *Round oak oiled nature: not available. Black oiled legs: Limited stock available.*



For product information visit oceefour.com ↗

SHELL COLOURS

Standard Polypropylene



FRAME COLOURS



Standard







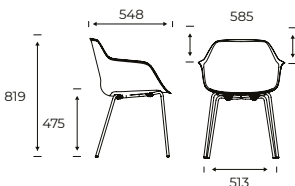

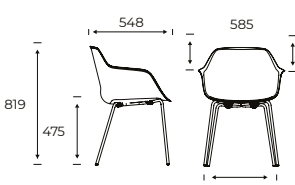
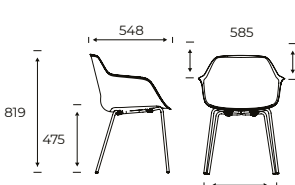

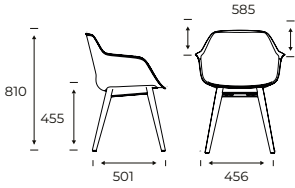

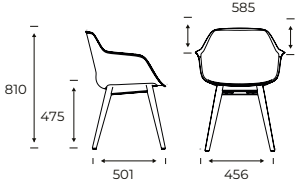

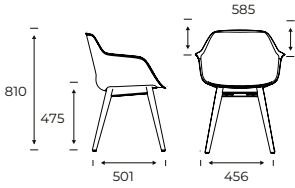

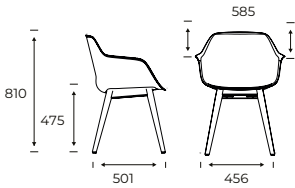

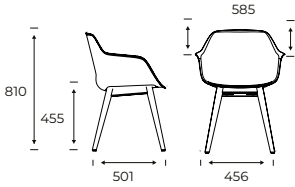
Frame optional*

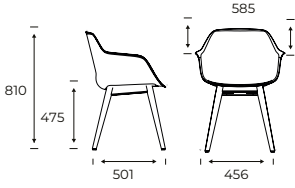

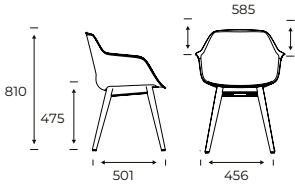

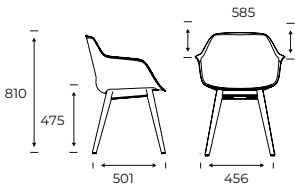
For full colour details [go to page 236](#) ↗

Product	Description (Item nr)	Weight (Kg)	Dimensions (mm)	Band	Standard PP (SEK)
	43000 FourMe® 44, Polypropylene shell	4.9		-	2.526
	43010 FourMe® 44, Seat pad	5.7		1 2 3 4 5 6 7 8 10	3.788 3.883 3.978 4.072 4.164 4.260 4.355 4.449 4.667
	43020 FourMe® 44, Inside upholstery	5.3		1 2 3 4 5 6 7 8 10	5.214 5.563 5.910 6.259 6.609 6.958 7.306 7.653 8.351
	43030 FourMe® 44, Fully upholstered	5.4		1 2 3 4 5 6 7 8 10	5.989 6.434 6.875 7.320 7.763 8.205 8.648 9.091 9.978

Product	Description (Item nr)	Weight (Kg)	Dimensions (mm)	Band	Standard PP (SEK)
	43000* FourMe® 44, Polypropylene shell, Oak oil, nature	4.9		-	3.778
	43010* FourMe® 44, Seat pad, Oak oil, nature	5.7		1 2 3 4 5 6 7 8 10	5.040 5.135 5.230 5.324 5.416 5.512 5.607 5.701 5.919
	43020* FourMe® 44, Inside upholstery, Oak oil, nature	5.3		1 2 3 4 5 6 7 8 10	6.466 6.815 7.162 7.511 7.861 8.210 8.558 8.905 9.603
	43030* FourMe® 44, Fully upholstered, Oak oil, nature	5.4		1 2 3 4 5 6 7 8 10	7.241 7.686 8.127 8.572 9.015 9.457 9.900 10.343 11.230
	43000 FourMe® 44, Polypropylene shell, Oak lacquered	4.9		-	4.149
	43010 FourMe® 44, Seat pad, Oak lacquered	5.7		1 2 3 4 5 6 7 8 10	5.411 5.506 5.601 5.695 5.787 5.883 5.978 6.072 6.290
	43020 FourMe® 44, Inside upholstery, Oak lacquered	5.3		1 2 3 4 5 6 7 8 10	6.837 7.186 7.533 7.882 8.232 8.581 8.929 9.276 9.974
	43030 FourMe® 44, Fully upholstered, Oak lacquered	5.4		1 2 3 4 5 6 7 8 10	7.612 8.057 8.498 8.943 9.386 9.828 10.271 10.714 11.601

Product	Description (Item nr)	Weight (Kg)	Dimensions (mm)	Band	Standard PP (SEK)
	4904 Loose seat pad (Only available for chairs without upholstery)	4.1		1	1.465
				2	1.561
				3	1.657
				4	1.753
				5	1.851
				6	1.947
				7	2.042
				8	2.138
				10	2.360

ACCESSORIES	Description	Weight (Kg)	Dimensions (mm)	Price (SEK)
	CHAIR FEET Felt glides, set of 4 pcs. height + 0,2 cm	1,82 g x 4		208
	CHAIR FEET Set of 4 pcs. Noise reducing ferrule with big diameter (reduces pressure marks) Chair height + 0,8 cm	4,8 g x 4		276
	CHAIR FEET Noise reducing ferrule with felt, set of 4 pcs. Chair height + 1 cm	6,6 g x 4		276
	CHAIR FEET Teflon glides, set of 4 pcs. Chair height + 0,2 cm	2,75 g x 4		208

SURCHARGE		Price (SEK)
FRAME OPTIONAL	 P	443
	 V	446



FEATURES

- Polyamide glides as standard
- Powder coated frame options

For product information visit oceefour.com ↗

SHELL COLOURS

Standard Polypropylene



FRAME COLOURS

Standard



For full colour details [go to page 236](#) ↗

Product	Description (Item nr)	Weight (Kg)	Dimensions (mm)	Band	Standard PP (SEK)
	43200 FourMe® 88, Polypropylene shell	5,9		-	2.982
	43210 FourMe® 88, Seat pad	6,7		1 2 3 4 5 6 7 8 10	4.244 4.339 4.434 4.528 4.620 4.716 4.811 4.905 5.123
	43220 FourMe® 88, Inside upholstery	6,3		1 2 3 4 5 6 7 8 10	5.670 6.019 6.366 6.715 7.065 7.414 7.762 8.109 8.807
	43230 FourMe® 88, Fully upholstered	6,4		1 2 3 4 5 6 7 8 10	6.445 6.890 7.331 7.776 8.219 8.661 9.104 9.547 10.434

Product	Description (Item nr)	Weight (Kg)	Dimensions (mm)	Band	Standard PP (SEK)
	4904 Loose seat pad (Only available for chairs without upholstery)	4.1		1	1.465
				2	1.561
				3	1.657
				4	1.753
				5	1.851
				6	1.947
				7	2.042
				8	2.138
				10	2.360

ACCESSORIES	Description	Weight (Kg)	Dimensions (mm)	Price (SEK)
	CHAIR FEET Felt glides, set of 4 pcs. height + 0,2 cm	1,82 g x 4		208
	CHAIR FEET Teflon glides, set of 4 pcs. Chair height + 0,2 cm	2,75 g x 4		208



FEATURES

- Inno® Tab, flexible and rotating writing tablet
- Gas lift, 41-57,5 cm
- Black base with castors as standard
- Aluminium base options

For product information visit oceefour.com ↗

SHELL COLOURS

Standard Polypropylene



FRAME COLOURS



Standard







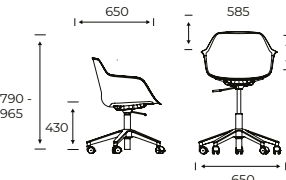

Frame optional*

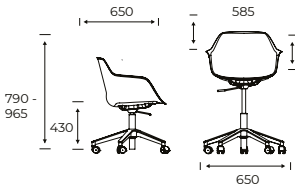

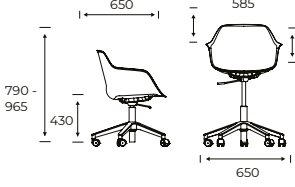
For full colour details [go to page 236](#) ↗

Product	Description (Item nr)	Weight (Kg)	Dimensions (mm)	Band	Standard PP (SEK)
	43404 FourMe® 66, Polypropylene shell, Without tilt with gas	7.5		-	3.283
	43405 FourMe® 66, Polypropylene shell, With tilt with gas	7.5		-	3.647
	43414 FourMe® 66, Seat pad, Without tilt with gas	8.4		1 2 3 4 5 6 7 8 10	4.545 4.640 4.735 4.829 4.921 5.017 5.112 5.206 5.424
	43415 FourMe® 66, Seat pad, With tilt with gas	8.4		1 2 3 4 5 6 7 8 10	4.909 5.004 5.099 5.193 5.285 5.381 5.476 5.570 5.788

Product	Description (Item nr)	Weight (Kg)	Dimensions (mm)	Band	Standard PP (SEK)
	43424 FourMe® 66, Inside upholstery, Without tilt with gas	7.9		1	5.971
				2	6.320
				3	6.667
				4	7.016
				5	7.366
				6	7.715
				7	8.063
				8	8.410
				10	9.108
					43425 FourMe® 66, Inside upholstery, With tilt with gas
2	6.684				
3	7.031				
4	7.380				
5	7.730				
6	8.079				
7	8.427				
8	8.774				
10	9.472				
	43434 FourMe® 66, Fully upholstered, Without tilt with gas	8.1			
				2	7.191
				3	7.632
				4	8.077
				5	8.520
				6	8.962
				7	9.405
				8	9.848
				10	10.735
					43435 FourMe® 66, Fully upholstered, With tilt with gas
2	7.555				
3	7.996				
4	8.441				
5	8.884				
6	9.326				
7	9.769				
8	10.212				
10	11.099				
	4904 Loose seat pad (Only available for chairs without upholstery)	4.1			
				2	1.561
				3	1.657
				4	1.753
				5	1.851
				6	1.947
				7	2.042
				8	2.138
				10	2.360

ACCESSORIES	Description	Weight (Kg)	Dimensions (mm)	Price (SEK)
	FOOTRING Gas lift including footring Spand 41 cm. - 57,5 cm.		585 - 845 mm	1.368
	With GS certification			1.489
	CHAIR FEET Castor with breaks, hard			599
	INNO Foldable Inno® Tab in black with integrated cup holder and dashboard for tablet and phone.	2,7 KG	520 x 320 x 23 mm	2.125

SURCHARGE		Price (SEK)
FRAME OPTIONAL	 4	643



Share Basic

Design by Strand+Hvass

[Content ↗](#)



FEATURES



- Take a more informal seat, Share allows you to sit however you feel comfortable – even back to front!
- Customise your chair with a range of standard materials, finishes and colours to choose from
- The following versions SH1, SH2 & SH01 of Share Basic are ecolabeled. This certification applies to all colours and finishes.
- Designed for disassembly – replace parts with ease, including upholstered seat covers.
- Inno®Note tablet options
- Frame available in black, stone grey or white
- Visible fasteners will match the frame colour
- Back cover available in a range of colours
- Curved ledge on the back rest is only available for Polypropylene
- Noise reducing glides
- Stacking protection in black under seat

For product information visit oceefour.com ↗

SEAT / BACK COLOURS





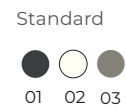



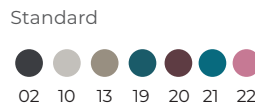

FRAME COLOURS

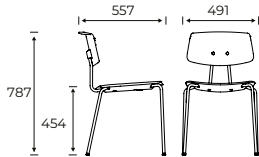

BACK COVER COLOURS

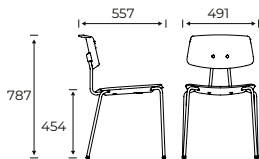

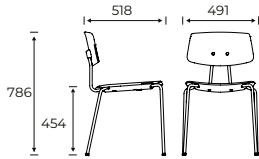
For full colour details [go to page 236](#) ↗

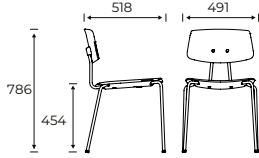



Product	Description (Item nr)	Weight (Kg)	Stacking on floor	Dimensions (mm)	Band	Price (SEK)
 	SH1 Share Basic, Polypropylene	5	12		-	2.387
	SH03 Polypropylene Back, Upholstered Seat	5	10		1 2 3 4 5 6 7 8 10	2.810 3.007 3.204 3.401 3.599 3.796 3.993 4.190 4.387
 	SH2 Share Basic, Veneer	4.6	12		-	3.232
	SH04 Share Basic, Veneer Back, Upholstered Seat	4.8	10		1 2 3 4 5 6 7 8 10	3.655 3.852 4.049 4.246 4.444 4.641 4.838 5.035 5.232

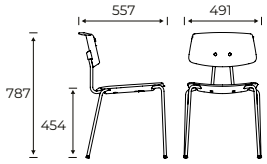

Share Basic

Design by Strand+Hvass

[Content ↗](#)

Product	Description (Item nr)	Weight (Kg)	Stacking on floor	Dimensions (mm)	Band	Price (SEK)
	SH01 Share Basic, Polypropylene Back, Veneer Seat	4.8	12		-	2.951

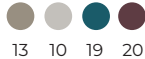
ACCESSORIES	Description	Weight (Kg)	Dimensions (mm)	Price (SEK)
	INNO Inno® Note in black, removable and foldable. Not available for chairs with Loop armrest and chairs with wooden legs.	1,4 KG	225 x 325 x 10 mm	1.522
	INNO@NOTE TROLLEY - 20100007 Trolley for Inno® Note. Room for 51 Inno® Notes.	58,5 Kg	1532 x 662 x 1199 mm	19.942
	SEAT ROW NUMBER - ACSR0101 16 mm - no. 1 -25	29 g		1.579
	SEAT ROW NUMBER - ACSR0102 16 mm - no. 26 -50	29 g		1.579
	CHAIR TROLLEY - 200X0 28 chairs with seat pad or 20 chairs with full upholstery	33,5 Kg	1100 x 560 x 1910 / 1980 mm	10.373

SURCHARGE		Price (SEK)
PP SEAT / BACK OPTIONAL		141
VENEER SEAT / BACK OPTIONAL		141

Share Stool with Steel Legs

Design by Strand+Hvass

[Content](#) ↗



FEATURES

- Take a more informal seat, the Share Stool allows you to sit however you feel comfortable
- Boost comfort with upholstered seat pad or fully upholstered seat option
- Visible fasteners will match the colour of the steel legs
- Option to have seat in black lacquered oak
- PE glides are standard
- Available in 3 heights
- We do not recommend suspensions to fully upholstered and black lacquered versions
- *Share Stools with wooden shell without visible fasteners: Limited stock available



For product information visit oceefour.com ↗

SHELL COLOURS

Veneer



03

FRAME COLOURS

Standard









01 02 03

Optional Seat

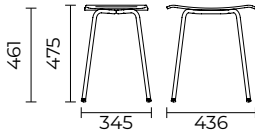

04

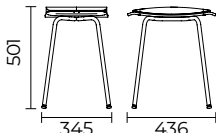
For full colour details [go to page 236](#) ↗

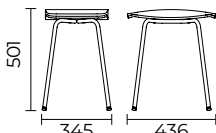
Product	Description (Item nr)	Weight (Kg)	Dimensions (mm)	Band	Veneer (SEK)	Optional veneer (SEK)
	SHF15 Share Stool with Steel Legs, Wooden shell with visible fasteners, Tableheight 74	2.4		-	2.094	2.539
	64040* Share Stool with Steel Legs, Wooden shell, Tableheight 74	2.4		-	2.094	2.539
	SHF16 Share Stool with Steel Legs, Seat pad, wooden shell, Tableheight 74	2.7		1 2 3 4 5 6 7 8 10	2.980 3.073 3.167 3.259 3.351 3.443 3.538 3.630 3.730	3.425 3.518 3.612 3.704 3.796 3.888 3.983 4.075 4.175
	SHF14 Share Stool with Steel Legs, Fully upholstered, Tableheight 74	2.6		1 2 3 4 5 6 7 8 10	3.341 3.434 3.526 3.619 3.714 3.807 3.899 3.993 4.208	

Share Stool with Steel Legs

[Content ↗](#)

Design by Strand+Hvass

Product	Description (Item nr)	Weight (Kg)	Dimensions (mm)	Band	Veneer (SEK)	Optional veneer (SEK)
	SHF25 Share Stool with Steel Legs, Wooden shell with visible fasteners, Tableheight 90	4		-	2.498	2.943
	64041* Share Stool with Steel Legs, Wooden shell, Tableheight 90	4		-	2.498	2.943
	SHF26 Share Stool with Steel Legs, Seat pad, wooden shell, Tableheight 90	4.3		1 2 3 4 5 6 7 8 10	3.527 3.621 3.710 3.810 3.900 3.994 4.086 4.179 4.398	3.972 4.066 4.155 4.255 4.345 4.439 4.531 4.624 4.843
	SHF24 Share Stool with Steel Legs, Fully upholstered, Tableheight 90	4.1		1 2 3 4 5 6 7 8 10	3.890 3.984 4.077 4.169 4.263 4.355 4.448 4.542 4.759	
	SHF35 Share Stool with Steel Legs, Wooden shell with visible fasteners, Tableheight 105	4.3		-	2.892	3.337
	64042* Share Stool with Steel Legs, Wooden shell, Tableheight 105	4.3		-	2.892	3.337
	SHF36 Share Stool with Steel Legs, Seat pad, wooden shell, Tableheight 105	4.6		1 2 3 4 5 6 7 8 10	4.071 4.165 4.258 4.350 4.443 4.537 4.630 4.723 4.940	4.516 4.610 4.703 4.795 4.888 4.982 5.075 5.168 5.385
	SHF34 Share Stool with Steel Legs, Fully upholstered, Tableheight 105	4.5		1 2 3 4 5 6 7 8 10	4.434 4.525 4.620 4.712 4.807 4.897 4.991 5.085 5.300	

ACCESSORIES	Description	Weight (Kg)	Dimensions (mm)	Price (SEK)
	CHAIR FEET Felt glides, set of 4 pcs. height + 0,2 cm	1,82 g x 4		208

Share Stool with Wooden Legs

Design by Strand+Hvass

[Content ↗](#)



FEATURES

- Take a more informal seat, the Share Stool allows you to sit however you feel comfortable
- Boost comfort with upholstered seat pad or fully upholstered seat option
- Visible fasteners are available in black, grey and white
- Option to have seat in black lacquered oak
- Frame in black lacquered oak options
- PE glides are standard
- Available in 3 heights
- We do not recommend suspensions to fully upholstered and black lacquered versions
- *Share Stools with wooden shell without visible fasteners: Limited stock available



For product information visit oceefour.com ↗

SHELL COLOURS

Veneer



03

Optional Seat



04

FRAME COLOURS

Standard









U

Frame optional*

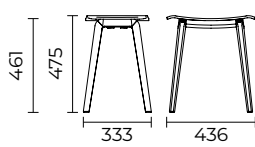

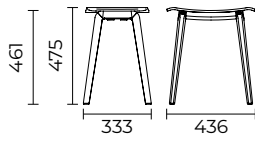

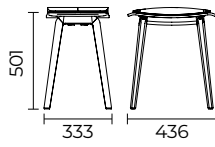

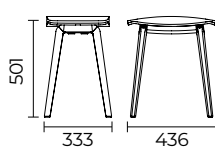







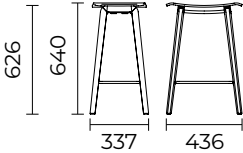

V

For full colour details [go to page 236](#) ↗

Product	Description (Item nr)	Weight (Kg)	Dimensions (mm)	Band	Veneer (SEK)	Optional veneer (SEK)
	SHG15 Share Stool with Wooden Legs, Wooden shell with visible fasteners, Tableheight 74	2.1		-	3.478	3.923
	63640* Share Stool with Wooden Legs, Wooden shell, Tableheight 74	2.1		-	3.478	3.923
	SHG16 Share Stool with Wooden Legs, Seat pad, wooden shell, Tableheight 74	2.4		1 2 3 4 5 6 7 8 10	4.614 4.704 4.793 4.882 4.973 5.062 5.151 5.241 5.450	5.059 5.149 5.238 5.327 5.418 5.507 5.596 5.686 5.895
	SHG14 Share Stool with Wooden Legs, Fully upholstered, Tableheight 74	2.3		1 2 3 4 5 6 7 8 10	4.963 5.052 5.141 5.232 5.320 5.410 5.501 5.589 5.799	

Share Stool with Wooden Legs

Design by Strand+Hvass

Product	Description (Item nr)	Weight (Kg)	Dimensions (mm)	Band	Veneer (SEK)	Optional veneer (SEK)
	SHG25 Share Stool with Wooden Legs, Wooden shell with visible fastners, Tableheight 90	3.5		-	4.872	5.317
	63641* Share Stool with Wooden Legs, Wooden shell, Tableheight 90	3.5		-	4.872	5.317
	SHG26 Share Stool with Wooden Legs, Seat pad, wooden shell, Tableheight 90	3.8		1 2 3 4 5 6 7 8 10	6.008 6.098 6.186 6.276 6.366 6.456 6.544 6.635 6.844	6.453 6.543 6.631 6.721 6.811 6.901 6.989 7.080 7.289
	SHG24 Share Stool with Wooden Legs, Fully upholstered, Tableheight 90	3.7		1 2 3 4 5 6 7 8 10	6.357 6.445 6.536 6.626 6.715 6.805 6.894 6.984 7.193	
	SHG35 Share Stool with Wooden Legs, Wooden shell with visible fastners, Tableheight 105	3.8		-	4.899	5.344
	63642* Share Stool with Wooden Legs, Wooden shell, Tableheight 105	3.8		-	4.899	5.344
	SHG36 Share Stool with Wooden Legs, Seat pad, wooden shell, Tableheight 105	4.1		1 2 3 4 5 6 7 8 10	6.035 6.124 6.214 6.303 6.394 6.482 6.572 6.662 6.871	6.480 6.569 6.659 6.748 6.839 6.927 7.017 7.107 7.316
	SHG34 Share Stool with Wooden Legs, Fully upholstered, Tableheight 105	3.9		1 2 3 4 5 6 7 8 10	6.383 6.473 6.563 6.651 6.740 6.832 6.922 7.010 7.221	

Share Stool with Wooden Legs

Design by Strand+Hvass

[Content ↗](#)

ACCESSORIES	Description	Weight (Kg)	Dimensions (mm)	Price (SEK)
	FOOT REST COLOUR Black matt standard Ral 7021			
	FOOT REST COLOUR White matt standard Ral 9010			
	FOOT REST COLOUR Stonegrey matt standard Ral 7039			

SURCHARGE		Price (SEK)
FRAME OPTIONAL	 V	445



Share Bench with Steel Legs

Design by Strand+Hvass

[Content ↗](#)



FEATURES

- Take a more informal seat, the Share Bench allows you to sit however you feel comfortable
- Boost comfort with upholstered seat pad or fully upholstered seat option
- Visible fasteners will match the colour of the steel legs
- Option to have seat in black lacquered oak
- PE glides are standard
- Available in 3 lengths
- We do not recommend suspensions to fully upholstered and black lacquered versions
- *Share Bench with wooden shell without visible fasteners: Limited stock available



For product information visit oceefour.com ↗

SHELL COLOURS

Veneer



03

FRAME COLOURS

Standard



01 02 03

Optional Seat



04











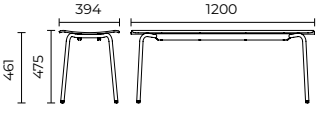

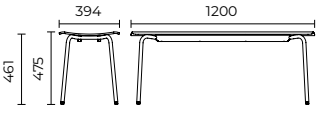
For full colour details [go to page 236](#) ↗

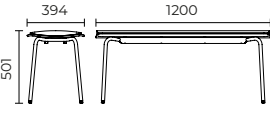
Product	Description (Item nr)	Weight (Kg)	Dimensions (mm)	Band	Veneer (SEK)	Optional veneer (SEK)
	SHH15 Share Bench with Steel Legs, Wooden shell with visible fasteners, 1000 mm	6.2		-	3.718	4.163
	64341* Share Bench with Steel Legs, Wooden shell, 1000 mm	6.2		-	3.718	4.163
	SHH16 Share Bench with Steel Legs, Seat pad, wooden shell, 1000 mm	7.1		1 2 3 4 5 6 7 8 10	5.874 6.148 6.423 6.696 6.971 7.244 7.519 7.794 8.370	6.319 6.593 6.868 7.141 7.416 7.689 7.964 8.239 8.815
	SHH14 Share Bench with Steel Legs, Fully upholstered, 1000 mm	6.8		1 2 3 4 5 6 7 8 10	6.539 6.813 7.088 7.361 7.634 7.907 8.183 8.456 9.032	

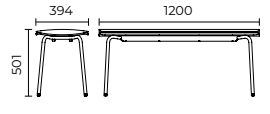
Share Bench with Steel Legs

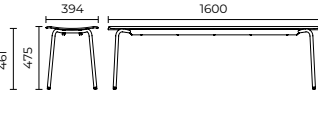
[Content ↗](#)

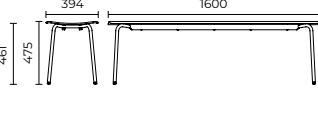
Design by Strand+Hvass

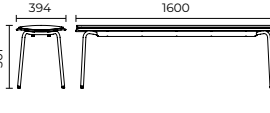
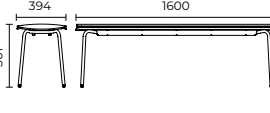
Product	Description (Item nr)	Weight (Kg)	Dimensions (mm)	Band	Veneer (SEK)	Optional veneer (SEK)
	SHH215 Share Bench with Steel Legs, Wooden shell with visible fastners, 1200 mm	7		-	3.984	4.429
	64342* Share Bench with Steel Legs, Wooden shell, 1200 mm	7		-	3.984	4.429
	SHH216 Share Bench with Steel Legs, Seat pad, wooden shell, 1200 mm	8.1		1 2 3 4 5 6 7 8 10	6.265 6.663 7.062 7.460 7.859 8.257 8.655 9.053 9.755	6.710 7.108 7.507 7.905 8.304 8.702 9.100 9.498 10.200
	SHH214 Share Bench with Steel Legs, Fully upholstered, 1200 mm	7.6		1 2 3 4 5 6 7 8 10	6.929 7.327 7.726 8.124 8.523 8.921 9.319 9.717 10.420	
	SHH315 Share Bench with Steel Legs, Wooden shell with visible fastners, 1600 mm	5.1		-	4.647	5.092
	64343* Share Bench with Steel Legs, Wooden shell, 1600 mm	5.1		-	4.647	5.092
	SHH316 Share Bench with Steel Legs, Seat pad, wooden shell, 1600 mm	6.5		1 2 3 4 5 6 7 8 10	7.884 8.571 9.261 9.949 10.639 11.327 12.015 12.705 13.697	8.329 9.016 9.706 10.394 11.084 11.772 12.460 13.150 14.142
	SHH314 Share Bench with Steel Legs, Fully upholstered, 1600 mm	5.9		1 2 3 4 5 6 7 8 10	7.221 7.907 8.597 9.286 9.975 10.663 11.352 12.041 13.034	

ACCESSORIES	Description	Weight (Kg)	Dimensions (mm)	Price (SEK)
	CHAIR FEET Felt glides, set of 4 pcs. height + 0,2 cm	1,82 g x 4		208







FEATURES

- CMHR foam

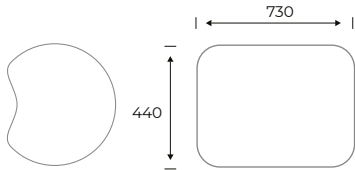
For product information visit oceefour.com ↗

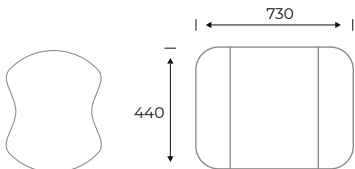
For full colour details [go to page 236](#) ↗

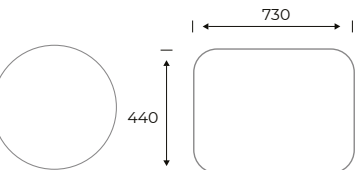
Product	Description (Item nr)	Weight (Kg)	Dimensions (mm)	Band	Standard (SEK)														
	CASINOCA1 Casino CAS1C, CAS1C	-		<table border="1"> <tr><td>1</td><td>3.787</td></tr> <tr><td>2</td><td>4.234</td></tr> <tr><td>3</td><td>4.646</td></tr> <tr><td>4</td><td>5.442</td></tr> <tr><td>5</td><td>6.510</td></tr> <tr><td>6</td><td>8.127</td></tr> <tr><td>7</td><td>9.794</td></tr> </table>	1	3.787	2	4.234	3	4.646	4	5.442	5	6.510	6	8.127	7	9.794	
1	3.787																		
2	4.234																		
3	4.646																		
4	5.442																		
5	6.510																		
6	8.127																		
7	9.794																		
	CASINOCA2 Casino CAS2C, CAS2C	-		<table border="1"> <tr><td>1</td><td>3.787</td></tr> <tr><td>2</td><td>4.234</td></tr> <tr><td>3</td><td>4.646</td></tr> <tr><td>4</td><td>5.442</td></tr> <tr><td>5</td><td>6.510</td></tr> <tr><td>6</td><td>8.127</td></tr> <tr><td>7</td><td>9.794</td></tr> </table>	1	3.787	2	4.234	3	4.646	4	5.442	5	6.510	6	8.127	7	9.794	
1	3.787																		
2	4.234																		
3	4.646																		
4	5.442																		
5	6.510																		
6	8.127																		
7	9.794																		
	CASINOCAC Casino CAS1CIRC, CAS1CIRC	-		<table border="1"> <tr><td>1</td><td>3.787</td></tr> <tr><td>2</td><td>4.234</td></tr> <tr><td>3</td><td>4.646</td></tr> <tr><td>4</td><td>5.442</td></tr> <tr><td>5</td><td>6.510</td></tr> <tr><td>6</td><td>8.127</td></tr> <tr><td>7</td><td>9.794</td></tr> </table>	1	3.787	2	4.234	3	4.646	4	5.442	5	6.510	6	8.127	7	9.794	
1	3.787																		
2	4.234																		
3	4.646																		
4	5.442																		
5	6.510																		
6	8.127																		
7	9.794																		



FourReal® 74 with Angled Legs

Design by Studio Ocee

[Content ↗](#)



FEATURES

- Table height 74 cm. Angled legs - integrated castors on two legs.
- With height adjustment glides on the other two legs to aid movement
- Foldable by one person without the use of tools. Matching ABS edges.
- Room In Room & Chair suspension options. Room In Room comes in Decor as standard.
- Electrical units are optional and will be positioned in the centre of tables as standard.



For product information visit oceefour.com ↗

TABLE TOP

Decor



Laminate



Fenix laminate



Linoleum



FRAME COLOURS

Standard



Frame optional*



For electrical accessories [go to page 228](#) ↗

For full colour details [go to page 236](#) ↗









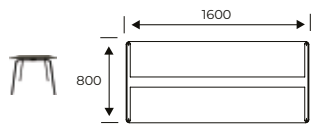

Product	Description (Item nr)	Weight (Kg)	Chair suspension	Dimensions (mm)	Top/Band	Price (SEK)
	21980 FourReal® 74 with Angled Legs, 80 x 80, Folding legs	19.5	2		Decor Laminate Fenix laminate Linoleum	6.245 6.712 8.003 9.407
	21800 FourReal® 74L with Angled Legs, 128 x 64, Folding legs	21.4	2		Decor Laminate Fenix laminate Linoleum	6.525 7.377 9.195 11.021
	21810 FourReal® 74L with Angled Legs, 140 x 70, Folding legs	24.1	2		Decor Laminate Fenix laminate Linoleum	6.731 7.745 10.005 11.390
	21900 FourReal® 74 with Angled Legs, 120 x 80, Folding legs	24	4		Decor Laminate Fenix laminate Linoleum	6.615 7.628 9.781 11.146
	21910 FourReal® 74 with Angled Legs, 140 x 80, Folding legs	26.3	4		Decor Laminate Fenix laminate Linoleum	6.909 7.987 10.648 11.797

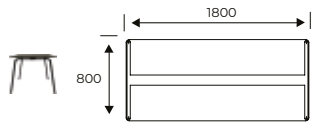
For tabletop cutout placements go to: Oceedesign.com/Cutout.pdf

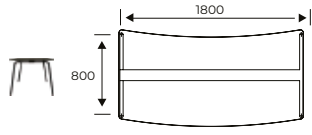
FourReal® 74 with Angled Legs

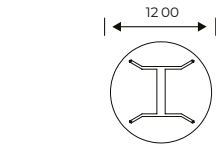
[Content ↗](#)

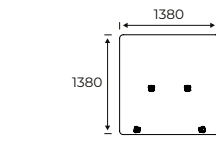
Design by Studio Ocee

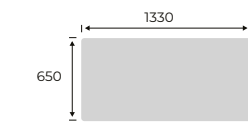



Product	Description (Item nr)	Weight (Kg)	Chair suspension	Dimensions (mm)	Top/Band	Price (SEK)
	21950 FourReal® 74 with Angled Legs, 160 x 80, Folding legs	31.6	4		Decor	7.280
					Laminate	8.599
					Fenix laminate	11.765
					Linoleum	12.375
	21920 FourReal® 74 with Angled Legs, 180 x 80, Folding legs	31.5	6		Decor	7.481
					Laminate	8.930
					Fenix laminate	12.368
					Linoleum	12.684
	219A0 FourReal® 74 with Angled Legs, 180 x 80 curve, Folding legs	39.7	6		Decor	8.151
					Laminate	9.601
					Fenix laminate	13.593
					Linoleum	14.679
	21930 FourReal® 74 with Angled Legs, Ø120, Folding legs	27	2		Decor	7.247
					Laminate	8.532
					Fenix laminate	11.858
					Linoleum	13.373
	2421 Room in Room, FourReal® 74 with Angled Legs	26.3	-		Decor	3.502
					Laminate	
					Fenix laminate	
					Linoleum	
	2430000 Acoustic for RinR, 133 x 65	6.7	-		1	2.852
					2	3.065
					3	3.279
					4	3.503
					5	3.706
					6	3.909

[For tabletop cutout placements go to: Oceedesign.com/Cutout.pdf](https://oceedesign.com/Cutout.pdf)

FourReal® 74 with Angled Legs

Design by Studio Ocee

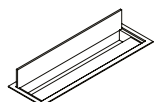
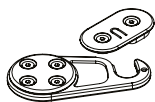
[Content ↗](#)

ACCESSORIES	Description	Weight (Kg)	Dimensions (mm)	Price (SEK)
	CHAIR SUSPENSION Chair suspension for FourCast2 Four, FourCast2 Line, FourSure 44, FourSure 88, FourSure 11, FourSure 99, Four Stools, Four Seating Benches	0,3 Kg		255
	CHAIR SUSPENSION Chair suspension for FourCast2 Wheeler, FourSure 66	0,3 Kg		255
	CABLE CUT OUT Cable duct, aluminum. Cable duct placed in apron			2.030
	CABLE CUT OUT			711
	LINKING DEVICE Linking Device, set of 4 pcs - 2 x he, 2 x she per table			525
	TABLE TROLLEY - 20100001 Trolley for 10 Folded Tables or 7 round tables, including strap	20 Kg	1720 mm x 550 mm x 980 mm. Folded Table: 150 mm	8.773
SURCHARGE				Price (SEK)
FRAME OPTIONAL	 6			382

FourReal® 74 with Straight Legs

Design by Studio Ocee

[Content](#) ↗



FEATURES

- Table height 74 cm. Straight legs – Integrated castors on two legs.
- With height adjustment glides on the other two legs to aid movement
- Foldable by one person without the use of tools. Matching ABS edges.
- Room In Room & Chair suspension options. Room In Room comes in Decor as standard.
- Electrical units are optional and will be positioned in the centre of tables as standard.



For product information visit oceefour.com ↗

TABLE TOP

Decor



04 05 06

Laminate



01 02 03

Fenix laminate



07 08 09

Linoleum



10

FRAME COLOURS

Standard



B C K

Frame optional*



6

For electrical accessories [go to page 228](#) ↗

For full colour details [go to page 236](#) ↗









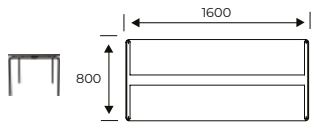

Product	Description (Item nr)	Weight (Kg)	Chair suspension	Dimensions (mm)	Top/Band	Price (SEK)
	22080 FourReal® 74 with Straight Legs, 80 x 80, Folding legs	20.2	2		Decor Laminate Fenix laminate Linoleum	6.245 6.712 8.003 9.407
	21600 FourReal® 74L with Straight Legs, 128 x 64, Folding legs	22	2		Decor Laminate Fenix laminate Linoleum	6.525 7.377 9.195 11.021
	21610 FourReal® 74L with Straight Legs, 140 x 70, Folding legs	24.7	2		Decor Laminate Fenix laminate Linoleum	6.731 7.745 10.005 11.390
	22000 FourReal® 74 with Straight Legs, 120 x 80, Folding legs	24.6	4		Decor Laminate Fenix laminate Linoleum	6.615 7.628 9.781 11.146
	22010 FourReal® 74 with Straight Legs, 140 x 80, Folding legs	26.9	4		Decor Laminate Fenix laminate Linoleum	6.909 7.987 10.648 11.797

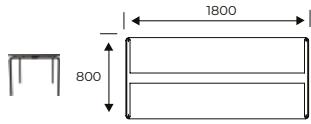
For tabletop cutout placements go to: Oceedesign.com/Cutout.pdf

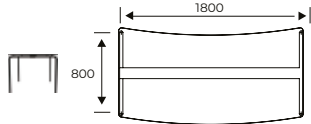
FourReal® 74 with Straight Legs

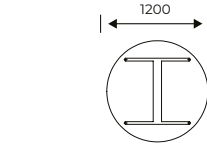
Design by Studio Ocee

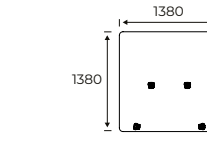
[Content ↗](#)

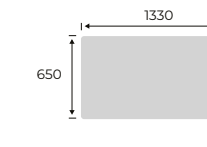



Product	Description (Item nr)	Weight (Kg)	Chair suspension	Dimensions (mm)	Top/Band	Price (SEK)
	22050 FourReal® 74 with Straight Legs, 160 x 80, Folding legs	32.2	4		Decor	7.280
					Laminate	8.599
					Fenix laminate	11.765
					Linoleum	12.375
	22020 FourReal® 74 with Straight Legs, 180 x 80, Folding legs	32.2	6		Decor	7.481
					Laminate	8.930
					Fenix laminate	12.368
					Linoleum	12.684
	220A0 FourReal® 74 with Straight Legs, 180 x 80 curve, Folding legs	-	6		Decor	8.151
					Laminate	9.601
					Fenix laminate	13.593
					Linoleum	14.679
	22030 FourReal® 74 with Straight Legs, Ø120, Folding legs	28.1	2		Decor	7.247
					Laminate	8.532
					Fenix laminate	11.858
					Linoleum	13.373
	2420 Room in Room, FourReal® 74 with Straight Legs	26.3	-		Decor	3.502
					Laminate	
					Fenix laminate	
					Linoleum	
	2430000 Acoustic for RinR, 133 x 65	6.7	-		1	2.852
					2	3.065
					3	3.279
					4	3.503
					5	3.706
					6	3.909

For tabletop cutout placements go to: [Oceedesign.com/Cutout.pdf](https://oceedesign.com/Cutout.pdf)

FourReal® 74 with Straight Legs

Design by Studio Ocee

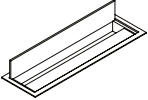
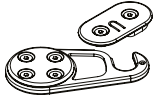
[Content ↗](#)

ACCESSORIES	Description	Weight (Kg)	Dimensions (mm)	Price (SEK)
	CHAIR SUSPENSION Chair suspension for FourCast2 Four, FourCast2 Line, FourSure 44, FourSure 88, FourSure 11, FourSure 99, Four Stools, Four Seating Benches	0,3 Kg		255
	CHAIR SUSPENSION Chair suspension for FourCast2 Wheeler, FourSure 66	0,3 Kg		255
	CABLE CUT OUT Cable duct, aluminum. Cable duct placed in apron			2.030
	CABLE CUT OUT			711
	LINKING DEVICE Linking Device, set of 4 pcs - 2 x he, 2 x she per table			525
	TABLE TROLLEY - 20100001 Trolley for 10 Folded Tables or 7 round tables, including strap	20 Kg	1720 mm x 550 mm x 980 mm. Folded Table: 150 mm	8.773
SURCHARGE				Price (SEK)
FRAME OPTIONAL	 6			382

FourReal® 741 Flake

Design by Studio Ocee

[Content ↗](#)



FEATURES



- Table height 74 cm. Angled legs – integrated castors on two legs
- With height adjustment glides on the other two legs to aid movement
- Foldable by one person without the use of tools. Matching ABS edges.
- Room In Room & Chair suspension options. Room In Room comes in Decor as standard.
- Powder coated frame options
- Electrical units are optional and will be positioned in the centre of tables as standard.

For product information visit oceefour.com ↗

TABLE TOP

Decor



Laminate



Fenix laminate



Linoleum



FRAME COLOURS

Standard



Frame optional*





For electrical accessories [go to page 228](#) ↗

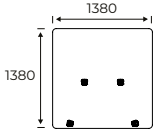

For full colour details [go to page 236](#) ↗

Product	Description (Item nr)	Weight (Kg)	Chair suspension	Dimensions (mm)	Top/Band	Price (SEK)
	21700 FourReal® 741 Flake, 140 x 100, Folding legs	33.9	4		Decor Laminate Fenix laminate Linoleum	8.126 9.446 13.079 14.279
	21720 FourReal® 741 Flake, 200 x 100, Folding legs	50.3	0		Decor Laminate Fenix laminate Linoleum	11.082 12.999 18.146 19.612
	21750 FourReal® 741 Flake, 198 x 100 ellipse, Folding legs	37.1	4		Decor Laminate Fenix laminate Linoleum	10.814 12.682 17.703 19.119
	21760 FourReal® 741 Flake, 160 x 100 half ellipse, Folding legs	31.6	4		Decor Laminate Fenix laminate Linoleum	8.514 9.783 12.323 13.308
	21770 FourReal® 741 Flake, 140 x 129 Diamond, Folding legs	30.4	3		Decor Laminate Fenix laminate Linoleum	9.029 10.872 13.955 15.068

For tabletop cutout placements go to: Oceedesign.com/Cutout.pdf

Product	Description (Item nr)	Weight (Kg)	Chair suspension	Dimensions (mm)	Top/Band	Price (SEK)
	2422 Room in Room, FourReal 741	26.4	-		Decor Laminate Fenix laminate Linoleum	3.502
	2430000 Acoustic for RinR, 133 x 65	6.7	-		1 2 3 4 5 6	2.852 3.065 3.279 3.503 3.706 3.909

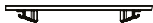
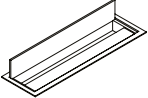
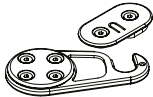
For tabletop cutout placements go to: [Oceedesign.com/Cutout.pdf](https://oceedesign.com/Cutout.pdf)

ACCESSORIES	Description	Weight (Kg)	Dimensions (mm)	Price (SEK)
	CHAIR SUSPENSION Chair suspension for FourCast2 Four, FourCast2 Line, FourSure 44, FourSure 88, FourSure 11, FourSure 99, Four Stools, Four Seating Benches	0,3 Kg		255
	CHAIR SUSPENSION Chair suspension for FourCast2 Wheeler, FourSure 66	0,3 Kg		255
	CABLE CUT OUT Cable duct, aluminum. Cable duct placed in apron			2.030
	CABLE CUT OUT			711
	LINKING DEVICE Linking Device, set of 4 pcs - 2 x he, 2 x she per table			525
	TABLE TROLLEY - 20100001 Trolley for 10 Folded Tables or 7 round tables, including strap	20 Kg	1720 mm x 550 mm x 980 mm. Folded Table: 150 mm	8.773

SURCHARGE		Price (SEK)
FRAME OPTIONAL	 6	382



FEATURES



- Table height 74 cm. Angled legs - integrated castors on two legs
- Optional 25 mm gap between tabletops for accessory mounting
- Personalise with trays, paper rolls, power cubes, acoustic panels and cable nets
- Electrical installation option for tabletops without 25 mm gap
- Possibility of chair suspension and to install cable net
- Powder-coated frame colour
- ABS edge matches tabletop colour
- Delivered flat-packed; easy to assemble and install

For product information visit oceefour.com ↗

TABLE TOP

Decor



Laminate



FRAME COLOURS

Standard



Fenix laminate



Linoleum







For electrical accessories [go to page 228](#) ↗



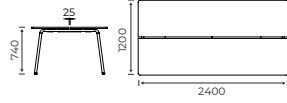

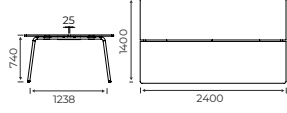

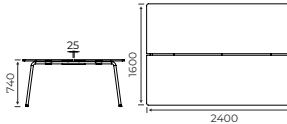
For full colour details [go to page 236](#) ↗

Product	Description (Item nr)	Weight (Kg)	Max Chair suspension	Dimensions (mm)	Top/Band	Price (SEK)
	REE16 FourReal® Flex, 120x120	37,8	4		Decor	11.717
					Laminate	13.730
					Fenix laminate	16.492
					Linoleum	18.406
	REE2H FourReal® Flex, 140x140	47,3	4		Decor	13.280
					Laminate	17.000
					Fenix laminate	18.163
					Linoleum	22.414
	REE35 FourReal® Flex, 160x160	57,7	4		Decor	14.842
					Laminate	19.710
					Fenix laminate	26.514
					Linoleum	25.875
	REE3U FourReal® Flex, 180x120	43,6	6		Decor	17.030
					Laminate	20.001
					Fenix laminate	22.572
					Linoleum	26.353
	REE4C FourReal® Flex, 200x140	54,2	6		Decor	19.530
					Laminate	25.716
					Fenix laminate	27.388
					Linoleum	32.524

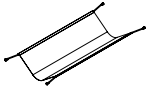
For tabletop cutout placements go to: [Oceefour.com/Cutout.pdf](https://oceefour.com/Cutout.pdf)

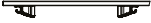
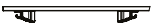
Product	Description (Item nr)	Weight (Kg)	Max Chair suspension	Dimensions (mm)	Top/Band	Price (SEK)
	REE69 FourReal® Flex, 240x120	65,7	8		Decor	20.155
					Laminate	20.155
					Fenix laminate	30.415
					Linoleum	33.835
	REE6A FourReal® Flex, 240x140	73,4	8		Decor	22.811
					Laminate	29.579
					Fenix laminate	32.478
					Linoleum	38.143
	REE6B FourReal® Flex, 240x160	81,2	8		Decor	26.405
					Laminate	34.999
					Fenix laminate	45.159
					Linoleum	43.680

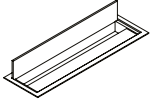
For tabletop cutout placements go to: [Oceefour.com/Cutout.pdf](https://oceefour.com/Cutout.pdf)

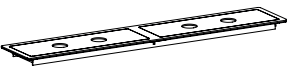
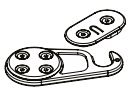
ACCESSORIES	Description	Weight (Kg)	Dimensions (mm)	Price (SEK)
	CABLE NET 620 – ACC1005		620 x H106 mm	452
	PAPER ROLL HOLDER – ACC1003 Incl. paper	2,6	L535 x W104 xH152 mm	764
	2 X CHAIR SUSPENSION			510
	4 X CHAIR SUSPENSION			1020
	6 X CHAIR SUSPENSION			1530
	8 X CHAIR SUSPENSION			2040
	CABLE CUT OUT Cable duct, aluminum. Cable duct placed in apron			2.030
	CD SINGLE CD1 Cable duct, Single, incl., hole in table top. Aluminium			3415
	CD DOUBLE CD2: Cable duct, double, incl., hole in table top. Aluminium			4183
	LINKING DEVICE Linking Device, set of 4 pcs - 2 x he, 2 x she per table			525



FEATURES

- Table height 90 cm. Angled legs – Integrated castors on two legs.
- With height adjustment glides on the other two legs to aid movement.
- Foldable by one person without use of tools. Matching ABS edges.
- Room In Room & Chair suspension options. Room In Room comes in Decor as standard.
- Electrical units are optional and will be positioned in the centre of tables as standard.



For product information visit oceefour.com ↗

TABLE TOP

Decor



Laminate



Fenix laminate



Linoleum



FRAME COLOURS

Standard



Frame optional*







For electrical accessories [go to page 228](#) ↗

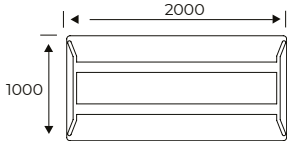

For full colour details [go to page 236](#) ↗

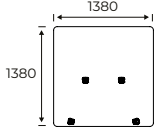
Product	Description (Item nr)	Weight (Kg)	Chair suspension	Dimensions (mm)	Top/Band	Price (SEK)
	22300 FourReal® 90, 140 x 60, Folding legs	25.1	0		Decor Laminate Fenix laminate Linoleum	7.326 8.440 10.510 11.423
	22310 FourReal® 90, 140 x 80, Folding legs	30.2	4		Decor Laminate Fenix laminate Linoleum	7.559 8.706 11.313 12.380
	22380 FourReal® 90, 160 x 80, Folding legs	30.5	4		Decor Laminate Fenix laminate Linoleum	7.941 9.147 12.744 13.578
	22320 FourReal® 90, 180 x 60, Folding legs	27.5	0		Decor Laminate Fenix laminate Linoleum	7.946 9.154 11.984 12.590
	22330 FourReal® 90, 180 x 80, Folding legs	33.1	6		Decor Laminate Fenix laminate Linoleum	8.150 9.384 13.515 14.221

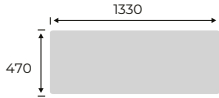
For tabletop cutout placements go to: Oceedesign.com/Cutout.pdf

Product	Description (Item nr)	Weight (Kg)	Chair suspension	Dimensions (mm)	Top/Band	Price (SEK)
	22360 FourReal® 90, 200 x 100, Folding legs	51.4	0		Decor	11.280
					Laminate	13.214
					Fenix laminate	18.347
					Linoleum	19.810
	2423 Room in Room, FourReal 90	26.4	-		Decor	3.502
					Laminate	
					Fenix laminate	
					Linoleum	
	2430001 Acoustic for RinR, 133 x 47	4.8	-		1	2.852
					2	3.065
					3	3.279
					4	3.503
					5	3.706
					6	3.909

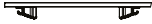
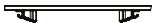
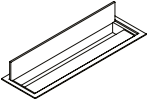
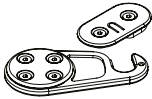
For tabletop cutout placements go to: [Oceedesign.com/Cutout.pdf](https://oceedesign.com/Cutout.pdf)

ACCESSORIES	Description	Weight (Kg)	Dimensions (mm)	Price (SEK)
	CHAIR SUSPENSION Chair suspension for FourCast2 Four, FourCast2 Line, FourSure 44, FourSure 88, FourSure 11, FourSure 99, Four Stools, Four Seating Benches	0,3 Kg		255
	CHAIR SUSPENSION Chair suspension for FourCast2 Wheeler, FourSure 66	0,3 Kg		255
	CABLE CUT OUT Cable duct, aluminum. Cable duct placed in apron			2.030
	CABLE CUT OUT			711
	LINKING DEVICE Linking Device, set of 4 pcs - 2 x he, 2 x she per table			525
	TABLE TROLLEY - 20100001 Trolley for 10 Folded Tables or 7 round tables, including strap	20 Kg	1720 mm x 550 mm x 980 mm. Folded Table: 150 mm	8.773
SURCHARGE				Price (SEK)
FRAME OPTIONAL	 6			382



FEATURES

- Table height 105 cm. Angled legs – Integrated castors on two legs.
- Foldable by one person without the use of tools. Matching ABS edges.
- Room In Room & Chair suspension options. Room In Room comes in Decor as standard.
- Electrical units are optional and will be positioned in the centre of tables as standard.



For product information visit oceefour.com ↗

TABLE TOP

Decor



Laminate



Fenix laminate



Linoleum



FRAME COLOURS

Standard



Frame optional*





For electrical accessories [go to page 228](#) ↗

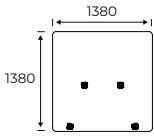

For full colour details [go to page 236](#) ↗

Product	Description (Item nr)	Weight (Kg)	Chair suspension	Dimensions (mm)	Top/Band	Price (SEK)
	22400 FourReal® 105, 140 x 60, Folding legs	26.1	0		Decor Laminate Fenix laminate Linoleum	7.323 8.440 10.510 11.423
	22410 FourReal® 105, 140 x 80, Folding legs	31.2	4		Decor Laminate Fenix laminate Linoleum	7.559 8.706 11.313 12.380
	22480 FourReal® 105, 160 x 80, Folding legs	31.5	4		Decor Laminate Fenix laminate Linoleum	7.941 9.147 12.744 13.578
	22420 FourReal® 105, 180 x 60, Folding legs	28.4	0		Decor Laminate Fenix laminate Linoleum	7.946 9.154 11.984 12.590
	22430 FourReal® 105, 180 x 80, Folding legs	34.2	6		Decor Laminate Fenix laminate Linoleum	8.150 9.384 13.515 14.266

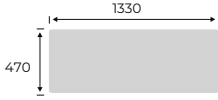
For tabletop cutout placements go to: Oceedesign.com/Cutout.pdf

Product	Description (Item nr)	Weight (Kg)	Chair suspension	Dimensions (mm)	Top/Band	Price (SEK)
	2424 Room in Room, FourReal 105	26.4	-		Decor Laminate Fenix laminate Linoleum	3.502
	2430001 Acoustic for RinR, 133 x 47	4.8	-		1 2 3 4 5 6	2.852 3.065 3.279 3.503 3.706 3.909

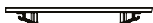
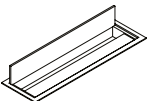
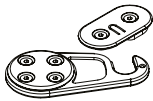
For tabletop cutout placements go to: [Oceedesign.com/Cutout.pdf](https://oceedesign.com/Cutout.pdf)

ACCESSORIES	Description	Weight (Kg)	Dimensions (mm)	Price (SEK)
	CHAIR SUSPENSION Chair suspension for FourCast2 Four, FourCast2 Line, FourSure 44, FourSure 88, FourSure 11, FourSure 99, Four Stools, Four Seating Benches	0,3 Kg		255
	CHAIR SUSPENSION Chair suspension for FourCast2 Wheeler, FourSure 66	0,3 Kg		255
	CABLE CUT OUT Cable duct, aluminum. Cable duct placed in apron			2.030
	CABLE CUT OUT			711
	LINKING DEVICE Linking Device, set of 4 pcs - 2 x he, 2 x she per table			525
	TABLE TROLLEY - 20100001 Trolley for 10 Folded Tables or 7 round tables, including strap	20 Kg	1720 mm x 550 mm x 980 mm. Folded Table: 150 mm	8.773

SURCHARGE		Price (SEK)
FRAME OPTIONAL	 6	382



FEATURES

- Table height 74 cm – integrated castors on two legs.
- Matching ABS edges.
- Chair suspension, Flower box & Top-shelf options.
- Powder coated frame options.
- Delivered unassembled.
- Electrical units are optional and will be positioned in the centre of tables as standard.

For product information visit oceefour.com ↗

TABLE TOP

Decor



Laminate



Fenix laminate



Linoleum



FRAME COLOURS

Standard







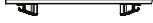

For electrical accessories [go to page 228](#) ↗

For full colour details [go to page 236](#) ↗

Product	Description (Item nr)	Weight (Kg)	Chair suspension	Dimensions (mm)	Top	Price (SEK)
	65025 FourReal® A 74, 140 x 80, A	44,1	4		Decor Laminate Fenix laminate Linoleum	9.130 9.961 13.215 14.753
	65015 FourReal® A 74, 180 x 80, A	52	6		Decor Laminate Fenix laminate Linoleum	9.713 10.921 14.963 15.652

For tabletop cutout placements go to: Oceedesign.com/Cutout.pdf

ACCESSORIES	Description	Weight (Kg)	Dimensions (mm)	Price (SEK)
	CHAIR SUSPENSION Chair suspension for FourCast2 Four, FourCast2 Line, FourSure 44, FourSure 88, FourSure 11, FourSure 99, Four Stools, Four Seating Benches	0,3 Kg		255
	CHAIR SUSPENSION Chair suspension for FourCast2 Wheeler, FourSure 66	0,3 Kg		255
	699000008 Table Accessories, Flower box black, 60 cm	0,4 Kg	L600 x W160 x H140 mm	438
	699000005 Table Accessories, Flower box black, 80 cm	0,5 Kg	L800 x W160 x H140 mm	438
	699000001 Table Accessories, Top shelf white, 60 cm x 20,5 cm	1,5 Kg	600 x 205 mm	438
	699000002 Table Accessories, Top shelf black, 60 cm x 20,5 cm	1,5 Kg	600 x 205 mm	438
	699000003 Table Accessories, Top shelf grey, 60 cm x 20,5 cm	1,5 Kg	600 x 205 mm	438



FEATURES

- Table height 74 cm – integrated castors on two legs
- Matching ABS edges.
- Chair suspension, Flower box & Top-shelf options.
- Powder coated frame options.
- Delivered unassembled.
- Electrical units are optional and will be positioned in the centre of tables as standard.

For product information visit oceefour.com ↗

TABLE TOP

Decor



Laminate



Fenix laminate



Linoleum



FRAME COLOURS

Standard



For electrical accessories [go to page 228](#) ↗

For full colour details [go to page 236](#) ↗

Product	Description (Item nr)	Weight (Kg)	Chair suspension	Dimensions (mm)	Top	Price (SEK)
	65205 FourReal® A XL 74, 180 x 100, A	69.4	6		Decor Laminate Fenix laminate Linoleum	16.268 17.647 20.144 22.468
	65215 FourReal® A XL 74, 200 x 100, A	74.4	6		Decor Laminate Fenix laminate Linoleum	18.076 19.608 22.381 24.964
	65225 FourReal® A XL 74, 240 x 100, A	84.4	8		Decor Laminate Fenix laminate Linoleum	20.660 22.364 25.808 28.391
	65209 FourReal® A XL 74, 180 x 100, A extension	58.7	6		Decor Laminate Fenix laminate Linoleum	13.685 15.063 17.561 19.884
	65219 FourReal® A XL 74, 200 x 100, A extension	63.6	6		Decor Laminate Fenix laminate Linoleum	15.493 17.214 19.797 22.381

For tabletop cutout placements go to: Oceedesign.com/Cutout.pdf





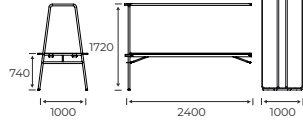

FourReal® A XL 74

Design by Studio Ocee

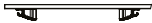
[Content ↗](#)

Product	Description (Item nr)	Weight (Kg)	Chair suspension	Dimensions (mm)	Top	Price (SEK)
	65229 FourReal® A XL 74, 240 x 100, A extension	77.5	8		Decor	18.076
					Laminate	19.781
					Fenix laminate	23.224
					Linoleum	25.808

For tabletop cutout placements go to: [Oceedesign.com/Cutout.pdf](https://oceedesign.com/Cutout.pdf)

ACCESSORIES	Description	Weight (Kg)	Dimensions (mm)	Price (SEK)
	CHAIR SUSPENSION Chair suspension for FourCast2 Four, FourCast2 Line, FourSure 44, FourSure 88, FourSure 11, FourSure 99, Four Stools, Four Seating Benches	0,3 Kg		255
	CHAIR SUSPENSION Chair suspension for FourCast2 Wheeler, FourSure 66	0,3 Kg		255
	699000008 Table Accessories, Flower box black, 60 cm	0,4 Kg	L600 x W160 x H140 mm	438
	699000005 Table Accessories, Flower box black, 80 cm	0,5 Kg	L800 x W160 x H140 mm	438
	699000001 Table Accessories, Top shelf white, 60 cm x 20,5 cm	1,5 Kg	600 x 205 mm	438
	699000002 Table Accessories, Top shelf black, 60 cm x 20,5 cm	1,5 Kg	600 x 205 mm	438
	699000003 Table Accessories, Top shelf grey, 60 cm x 20,5 cm	1,5 Kg	600 x 205 mm	438



FEATURES



- Table height 74 cm – integrated castors on two legs
- Optional 25 mm gap between tabletops for accessory mounting
- Personalise with trays, paper rolls, power cubes, acoustic panels and cable nets
- Available with a flower box and top shelf
- Electrical installation option for tabletops without 25 mm gap
- Possibility of chair suspension and to install cable net
- Powder-coated frame colour
- ABS edge matches tabletop colour
- Delivered flat-packed; easy to assemble and install

For product information visit oceefour.com ↗

TABLE TOP

Decor



Laminate



FRAME COLOURS

Standard



Fenix laminate



Linoleum











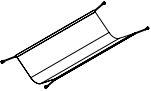
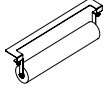

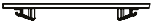

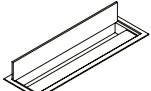
For electrical accessories [go to page 228](#) ↗

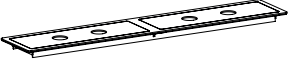
For full colour details [go to page 236](#) ↗

Product	Description (Item no)	Weight (Kg)	Max Chair suspension	Dimensions (mm)	Top/Band	Price (SEK)
	REF2E1 FourReal® A Flex, 140x120, 74	68	4		Decor Laminate Fenix laminate Linoleum	17.492 19.573 22.604 25.916
	REF2H1 FourReal® A Flex, 140x140, 74	72	4		Decor Laminate Fenix laminate Linoleum	18.117 21.837 23.000 27.251
	REF691 FourReal® A Flex, 240x120, 74	96,3	8		Decor Laminate Fenix laminate Linoleum	26.405 32.677 36.665 40.085
	REF6A1 FourReal® A Flex, 240x140, 74	103,2	8		Decor Laminate Fenix laminate Linoleum	28.905 35.673 38.572 44.237

For tabletop cutout placements go to: [Oceefour.com/Cutout.pdf](https://oceefour.com/Cutout.pdf)

ACCESSORIES	Description	Weight (Kg)	Dimensions (mm)	Price (SEK)
	CABLE NET 620 – ACC1005		L620 x H106 mm	452
	PAPER ROLL HOLDER – ACC1003 Incl. paper	2,6 Kg	L535 x W104 x H152 mm	764
	2 X CHAIR SUSPENSION			510
	4 X CHAIR SUSPENSION			1020
	6 X CHAIR SUSPENSION			1530
	8 X CHAIR SUSPENSION			2040
	CABLE CUT OUT Cable duct, aluminum. Cable duct placed in apron			2.030
	CD SINGLE CD1 Cable duct, Single, incl., hole in table top. Aluminium			3415
	CD DOUBLE CD2: Cable duct, double, incl., hole in table top. Aluminium			4183
	699000008 Table Accessories, Flower box black, 60 cm	0,4 Kg	L600 x W160 x H140 mm	438
	699000005 Table Accessories, Flower box black, 80 cm	0,5 Kg	L800 x W160 x H140 mm	438
	699000001 Table Accessories, Top shelf white, 60 cm x 20,5 cm	1,5 Kg	600 x 205 mm	438
	699000002 Table Accessories, Top shelf black, 60 cm x 20,5 cm	1,5 Kg	600 x 205 mm	438
	699000003 Table Accessories, Top shelf grey, 60 cm x 20,5 cm	1,5 Kg	600 x 205 mm	438

FourReal® A 90

Design by Studio Ocee

[Content ↗](#)



FEATURES

- Table height 90 cm – integrated castors on two legs.
- Matching ABS edges.
- Chair suspension, Flower box & Top-shelf options.
- Powder coated frame options.
- Delivered unassembled.
- Electrical units are optional and will be positioned in the centre of tables as standard.



For product information visit oceefour.com ↗

TABLE TOP

Decor



Laminate



Fenix laminate



Linoleum





FRAME COLOURS

Standard





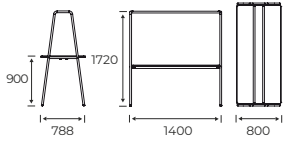

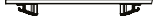

For electrical accessories [go to page 228](#) ↗

For full colour details [go to page 236](#) ↗

Product	Description (Item nr)	Weight (Kg)	Chair suspension	Dimensions (mm)	Top	Price (SEK)
	65125 FourReal® A 90, 140 x 80, A	43.8	4		Decor Laminate Fenix laminate Linoleum	9.130 9.961 13.215 14.753
	65115 FourReal® A 90, 180 x 80, A	51.7	6		Decor Laminate Fenix laminate Linoleum	9.713 10.921 14.963 15.652

For tabletop cutout placements go to: Oceedesign.com/Cutout.pdf

ACCESSORIES	Description	Weight (Kg)	Dimensions (mm)	Price (SEK)
	CHAIR SUSPENSION Chair suspension for FourCast2 Four, FourCast2 Line, FourSure 44, FourSure 88, FourSure 11, FourSure 99, Four Stools, Four Seating Benches	0,3 Kg		255
	CHAIR SUSPENSION Chair suspension for FourCast2 Wheeler, FourSure 66	0,3 Kg		255
	699000008 Table Accessories, Flower box black, 60 cm	0,4 Kg	L600 x W160 x H140 mm	438
	699000005 Table Accessories, Flower box black, 80 cm	0,5 Kg	L800 x W160 x H140 mm	438
	699000001 Table Accessories, Top shelf white, 60 cm x 20,5 cm	1,5 Kg	600 x 205 mm	438
	699000002 Table Accessories, Top shelf black, 60 cm x 20,5 cm	1,5 Kg	600 x 205 mm	438
	699000003 Table Accessories, Top shelf grey, 60 cm x 20,5 cm	1,5 Kg	600 x 205 mm	438

FourReal® A XL 90

Design by Studio Ocee

[Content ↗](#)



FEATURES

- Table height 90 cm – integrated castors on two legs.
- Matching ABS edges.
- Chair suspension, Flower box & Top-shelf options.
- Powder coated frame options.
- Delivered unassembled.
- Electrical units are optional and will be positioned in the centre of tables as standard.



For product information visit oceefour.com ↗

TABLE TOP

Decor



Laminate



Fenix laminate



Linoleum



FRAME COLOURS

Standard



For electrical accessories [go to page 228](#) ↗

For full colour details [go to page 236](#) ↗

Product	Description (Item nr)	Weight (Kg)	Chair suspension	Dimensions (mm)	Top	Price (SEK)
	65305 FourReal® A XL 90, 180 x 100, A	69.1	6		Decor Laminate Fenix laminate Linoleum	16.268 17.647 20.144 22.468
	65315 FourReal® A XL 90, 200 x 100, A	74.1	6		Decor Laminate Fenix laminate Linoleum	18.076 19.608 22.381 24.964
	65325 FourReal® A XL 90, 240 x 100, A	84	8		Decor Laminate Fenix laminate Linoleum	20.660 22.364 25.808 28.391
	65309 FourReal® A XL 90, 180 x 100, A extension	58.5	6		Decor Laminate Fenix laminate Linoleum	13.685 15.063 17.561 19.884
	65319 FourReal® A XL 90, 200 x 100, A extension	63.5	6		Decor Laminate Fenix laminate Linoleum	15.493 17.214 19.797 22.381

For tabletop cutout placements go to: Oceedesign.com/Cutout.pdf





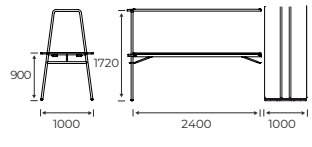

FourReal® A XL 90

Design by Studio Ocee

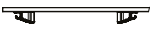
[Content ↗](#)

Product	Description (Item nr)	Weight (Kg)	Chair suspension	Dimensions (mm)	Top	Price (SEK)
	65329 FourReal® A XL 90, 240 x 100, A extension	73.5	8		Decor	18.076
					Laminate	19.781
					Fenix laminate	23.224
					Linoleum	25.808

For tabletop cutout placements go to: [Oceedesign.com/Cutout.pdf](https://oceedesign.com/Cutout.pdf)

ACCESSORIES	Description	Weight (Kg)	Dimensions (mm)	Price (SEK)
	CHAIR SUSPENSION Chair suspension for FourCast2 Four, FourCast2 Line, FourSure 44, FourSure 88, FourSure 11, FourSure 99, Four Stools, Four Seating Benches	0,3 Kg		255
	CHAIR SUSPENSION Chair suspension for FourCast2 Wheeler, FourSure 66	0,3 Kg		255
	699000008 Table Accessories, Flower box black, 60 cm	0,4 Kg	L600 x W160 x H140 mm	438
	699000005 Table Accessories, Flower box black, 80 cm	0,5 Kg	L800 x W160 x H140 mm	438
	699000001 Table Accessories, Top shelf white, 60 cm x 20,5 cm	1,5 Kg	600 x 205 mm	438
	699000002 Table Accessories, Top shelf black, 60 cm x 20,5 cm	1,5 Kg	600 x 205 mm	438
	699000003 Table Accessories, Top shelf grey, 60 cm x 20,5 cm	1,5 Kg	600 x 205 mm	438



FEATURES

- Table height 74 cm. Comes with 4 Castors with brakes.
- Foldable by one person without the use of tools
- Matching ABS edges
- Powder coated frame options
- To ensure optimum stability on uneven surfaces we would recommend specifying with adjustable castors
- Delivered unassembled

For product information visit oceefour.com ↗

TABLE TOP

Decor



Laminate



Fenix laminate



FRAME COLOURS









Standard

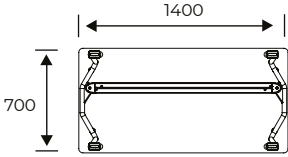

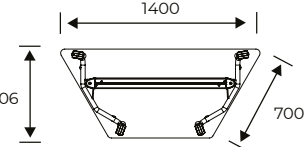

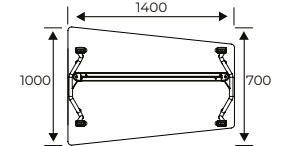

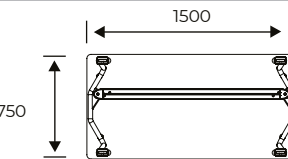
Frame optional*

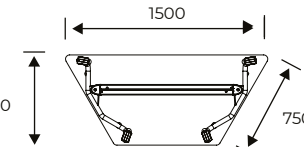

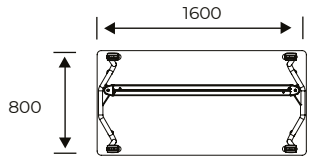
For full colour details [go to page 250](#) ↗

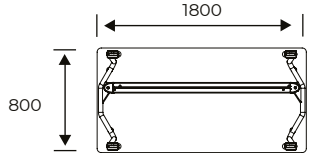
Product	Description (Item nr)	Weight (Kg)	Dimensions (mm)	Top	Price (SEK)
	66040 FourFold®, 140 x 70, Folding leg	25.7		Decor Laminate Fenix laminate	8.056 9.291 12.339
	66050 FourFold®, 140 x 70 trapez, Folding leg	19.9		Decor Laminate Fenix laminate	8.056 9.291 12.339
	66080 FourFold®, 140 x 70-100 Taper, Folding leg	29.3		Decor Laminate Fenix laminate	8.589 9.877 13.003
	66000 FourFold®, 150 x 75, Folding leg	28.5		Decor Laminate Fenix laminate	8.056 9.291 12.339
	66010 FourFold®, 150 x 75 trapez, Folding leg	21.9		Decor Laminate Fenix laminate	8.056 9.291 12.339

Product	Description (Item nr)	Weight (Kg)	Dimensions (mm)	Top	Price (SEK)
	66020 FourFold®, 160 x 80, Folding leg	31.3		Decor	9.065
				Laminate	10.787
				Fenix laminate	14.880
	66030 FourFold®, 180 x 80, Folding leg	34		Decor	9.670
				Laminate	11.393
				Fenix laminate	15.486

ACCESSORIES	Description	Weight (Kg)	Dimensions (mm)	Price (SEK)
	FEET Height adjustable castors in black with brakes			2.053
	LOCK Set of 2			408

SURCHARGE		Price (SEK)
FRAME OPTIONAL	 6	382

Acoustic Panels

Design by Studio Ocee

[Content](#) ↗



FEATURES



- Made of 60% recycled PET
- Available in two colors: Anthracite or Light Grey
- Hanging version (only for FourReal® A Flex) has black elastic straps and black steel clips
- Standing version can be mounted in the 25 mm gap on FourReal® Flex/A Flex
- Standing version can also be freestanding and used across all tables
- Trapezium shape complements the FourReal® Family
- Standing panel foot doubles as a device/magazine holder

For product information visit oceefour.com ↗

FELT FINISHES

Standard



For full colour details [go to page 236](#) ↗

Product	Description (Item no)	Weight (Kg)	Dimensions (mm)	Price (SEK)
	ATAC1661 Acoustic, Standing, 55x44T, Felt	1,6		1.905
	ATAC3661 Acoustic, Hanging, 55x44T, Felt	0,98		1.748
	ATAC1671 Acoustic, Standing, 110x44T, Felt	3,3		2.717
	ATAC3671 Acoustic, Hanging, 110x44T, Felt	1,9		2.561
	ATAC1681 Acoustic, Standing, 130x44T, Felt	3,6		2.920

Acoustic

Design by Studio Ocee

[Content ↗](#)

Product	Description (Item no)	Weight (Kg)	Dimensions (mm)	Price (SEK)
	ATAC3681 Acoustic, Hanging, 130x44T, Felt	2,2		2.764

ACCESSORIES	Description	Weight (Kg)	Dimensions (mm)	Price (€)
	ACOUSTIC STRAP – ACC1004		W50 xH440 mm	23

Tray

Design by Studio Ocee

[Content ↗](#)



FEATURES



- Two shapes: rectangular or circular
- Two heights: 8 cm or 14 cm
- Two finishes: natural oak or black oak veneer (70% FSC mix)
- Can be freestanding with a round steel foot
- Can be mounted in the 25 mm gap on FourReal Flex/A Flex
- Standing trays can be used across all products in our FourReal® Family
- Delivered flat-packed; easy to assemble and install

For product information visit oceefour.com ↗

COLOUR

Veneer









FRAME COLOURS

Standard

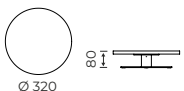

01



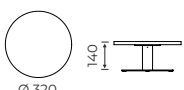

For full colour details [go to page 236](#) ↗

Product	Description (Item no)	Weight (Kg)	Dimensions (mm)	Top	Price (SEK)
	ATTR1641 Tray, Standing, Ø32, Height 80	2,7		Veneer	1.577
	ATTR2641 Tray, Fixed, Ø32, Height 80	1,3		Veneer	1.264
	ATTR1651 Tray, Standing, 60x24.5, Height 80	3,3		Veneer	1.827
	ATTR2651 Tray, Fixed, 60x24.5, Height 80	1,9		Veneer	1.514
	ATTR1642 Tray, Standing, Ø32, Height 140	2,9		Veneer	1.592

Tray

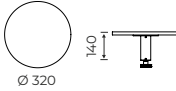
Design by Studio Ocee

[Content ↗](#)

Product	Description (Item no)	Weight (Kg)	Dimensions (mm)	Top	Price (SEK)
	ATTR2642 Tray, Fixed, Ø32, Height 140	1,4		Veneer	1.280
	ATTR1652 Tray, Standing, 60x24.5, Height 140	3,4		Veneer	1.842
	ATTR2652 Tray, Fixed, 60x24.5, Height 140	2		Veneer	1.530

Power Cube

Design by Studio Ocee

[Content ↗](#)



FEATURES

- Wooden power cube with Evoline ONE unit
- Power socket available in white or black
- USB A+C unit available in white or black
- GST18 socket
- 3 m black cord
- Cube available in natural or black solid oak
- 70% FSC mix

For product information visit oceefour.com ↗

COLOUR

Standard





UNIT COLOURS

Standard

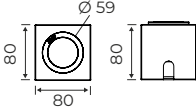

For full colour details [go to page 236](#) ↗

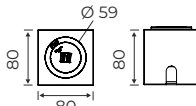
Product	Description (Item no)	Weight (Kg)	Dimensions (mm)	Colour	Price (SEK)
	APOW01 Power Cube, Power A16	1,05		Solid oak	1.639
	APOW02 Power Cube, USB A+C	1,05		Solid oak	2.342





FEATURES

- Table height 72,5 cm – integrated castors on two legs.
- With height adjustment glides on the other two legs to aid movement.
- Foldable by one person without the use of tools (thickness of folded table 15 cm).
- Matching ABS edges. Powder coated frame options.
- Electrical units are optional.



For product information visit oceefour.com ↗

TABLE TOP

Decor



Laminate



Fenix laminate



Linoleum





FRAME COLOURS

Standard



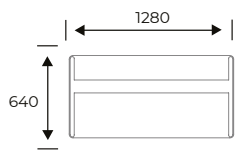

For electrical accessories [go to page 228](#) ↗

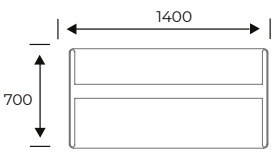
For full colour details [go to page 236](#) ↗

Product	Description (Item nr)	Weight (Kg)	Chair suspension	Dimensions (mm)	Top	Price (SEK)
	11630 Four® Learning, 128 x 64, Folding legs	22.5	2		Decor Laminate Fenix laminate Linoleum	7.012 7.866 9.679 11.511
	11610 Four® Learning, 140 x 70, Folding legs	25.9	2		Decor Laminate Fenix laminate Linoleum	7.215 8.233 10.493 11.879

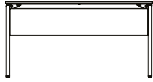
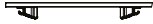
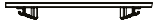
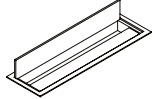
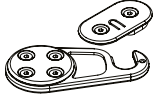
For tabletop cutout placements go to: Oceedesign.com/Cutout.pdf

ACCESSORIES	Description	Weight (Kg)	Dimensions (mm)	Price (SEK)
	MODESTY PANEL White			1.314
	MODESTY PANEL Black			1.314
	CHAIR SUSPENSION Chair suspension for FourCast2 Four, FourCast2 Line, FourSure 44, FourSure 88, FourSure 11, FourSure 99, Four Stools, Four Seating Benches	0,3 Kg		255
	CHAIR SUSPENSION Chair suspension for FourCast2 Wheeler, FourSure 66	0,3 Kg		255
	CABLE CUT OUT Cable duct, aluminum. Cable duct placed in apron			2.030
	CABLE CUT OUT			711
	LINKING DEVICE Linking Device, set of 4 pcs - 2 x he, 2 x she per table			525
	TABLE TROLLEY - 20100001 Trolley for 10 Folded Tables or 7 round tables, including strap	20 Kg	1720 mm x 550 mm x 980 mm. Folded Table: 150 mm	8.773



FEATURES

- Table height 72,5 cm – integrated castors on two legs with height adjustment.
- With height adjustment glides on the other two legs to aid movement.
- Foldable by one person without the use of tools.
- Matching ABS edges. Powder coated frame options.
- Electrical units are optional and will be positioned in the centre of tables as standard.

For product information visit oceefour.com ↗

TABLE TOP

Decor



Laminate



Fenix laminate



Linoleum



FRAME COLOURS

Standard



For electrical accessories [go to page 228](#) ↗



For full colour details [go to page 236](#) ↗

Product	Description (Item nr)	Weight (Kg)	Chair suspension	Dimensions (mm)	Top	Price (SEK)
	120E0 Four® Eating, 80 x 80 with 80 x 70 frame, Folding legs	17.9	2		Decor Laminate Fenix laminate Linoleum	5.247 7.103 8.551 10.085
	12000 Four® Eating, 120 x 80, Folding legs	23.4	4		Decor Laminate Fenix laminate Linoleum	7.104 8.116 10.265 11.630
	12050 Four® Eating, 140 x 80, Folding legs	28.4	4		Decor Laminate Fenix laminate Linoleum	7.397 8.476 11.137 12.285
	12040 Four® Eating, 160 x 80, Folding legs	31.4	4		Decor Laminate Fenix laminate Linoleum	7.672 9.048 11.984 12.741
	12010 Four® Eating, 180 x 80, Folding legs	34.3	6		Decor Laminate Fenix laminate Linoleum	7.968 9.417 12.855 13.171

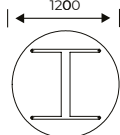
For tabletop cutout placements go to: Oceedesign.com/Cutout.pdf

Product	Description (Item nr)	Weight (Kg)	Chair suspension	Dimensions (mm)	Top	Price (SEK)
	12020 Four® Eating, Ø 120, Folding legs	24.9	2		Decor	7.735
					Laminate	9.017
					Fenix laminate	12.345
					Linoleum	13.861

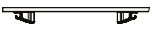
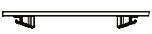
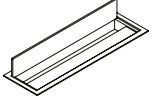
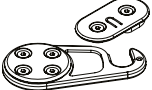
For tabletop cutout placements go to: [Oceedesign.com/Cutout.pdf](https://oceedesign.com/Cutout.pdf)

ACCESSORIES	Description	Weight (Kg)	Dimensions (mm)	Price (SEK)
	CHAIR SUSPENSION Chair suspension for FourCast2 Four, FourCast2 Line, FourSure 44, FourSure 88, FourSure 11, FourSure 99, Four Stools, Four Seating Benches	0,3 Kg		255
	CHAIR SUSPENSION Chair suspension for FourCast2 Wheeler, FourSure 66	0,3 Kg		255
	CABLE CUT OUT Cable duct, aluminum. Cable duct placed in apron			2.030
	CABLE CUT OUT			711
	LINKING DEVICE Linking Device, set of 4 pcs - 2 x he, 2 x she per table			525
	TABLE TROLLEY - 20100001 Trolley for 10 Folded Tables or 7 round tables, including strap	20 Kg	1720 mm x 550 mm x 980 mm. Folded Table: 150 mm	8.773

Four® Meeting

Design by Strand+Hvass

[Content ↗](#)



FEATURES

- Table height 72,5 cm – integrated castors on two legs.
- With height adjustment glides on the other two legs to aid movement.
- Foldable by one person without the use of tools (thickness of folded table 15 cm).
- Matching ABS edges. Powder coated frame options.
- Electrical units are optional and will be positioned in the centre of tables as standard.



For product information visit oceefour.com ↗

TABLE TOP

FRAME COLOURS

Standard



Laminate







Fenix laminate



Linoleum

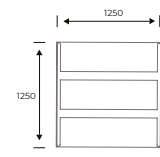

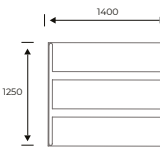
For full colour details [go to page 236](#) ↗

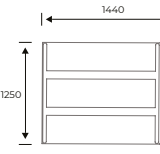



Product	Description (Item nr)	Weight (Kg)	Chair suspension	Dimensions (mm)	Top	Price (SEK)
	11730 Four® Meeting, 125 x 125, Folding legs	42.1	4		Laminate Fenix laminate Linoleum	13.486 18.061 19.362
	11750 Four® Meeting, 125 x 140, Folding legs	45.7	4		Laminate Fenix laminate Linoleum	14.218 18.602 19.881
	11740 Four® Meeting, 125 x 144 D-shape, Folding legs	39.1	4		Laminate Fenix laminate Linoleum	14.797 19.077 20.317

For tabletop cutout placements go to: Oceedesign.com/Cutout.pdf

Four® Meeting

Design by Strand+Hvass

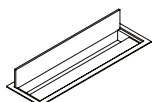
[Content ↗](#)

ACCESSORIES	Description	Weight (Kg)	Dimensions (mm)	Price (SEK)
	CHAIR SUSPENSION Chair suspension for FourCast2 Four, FourCast2 Line, FourSure 44, FourSure 88, FourSure 11, FourSure 99, Four Stools, Four Seating Benches	0,3 Kg		255
	CHAIR SUSPENSION Chair suspension for FourCast2 Wheeler, FourSure 66	0,3 Kg		255
	CABLE CUT OUT Cable duct, aluminum. Cable duct placed in apron			2.030
	CABLE CUT OUT			711
	LINKING DEVICE Linking Device, set of 4 pcs - 2 x he, 2 x she per table			525

Four® Standing

Design by Strand+Hvass

[Content ↗](#)



FEATURES

- Table height 90 & 103 cm
- Integrated castors on two legs
- Powder coated frame options
- Matching ABS edges

For product information visit oceefour.com ↗

TABLE TOP

Decor



Laminate



Fenix laminate



Linoleum



FRAME COLOURS

Standard



For full colour details [go to page 236](#) ↗





Product	Description (Item nr)	Weight (Kg)	Dimensions (mm)	Top	Price (SEK)
	12323 Four® Standing, 140 x 60, 90 cm	28.2		Decor	12.429
				Laminate	13.446
				Fenix laminate	16.095
				Linoleum	18.294
	12383 Four® Standing, 140 x 80, 90 cm	36.7		Decor	13.775
				Laminate	15.065
				Fenix laminate	18.726
				Linoleum	20.136
	12313 Four® Standing, 180 x 60, 90 cm	35.1		Decor	12.696
				Laminate	14.069
				Fenix laminate	18.420
				Linoleum	19.055
	12393 Four® Standing, 180 x 80, 90 cm	43.1		Decor	14.069
				Laminate	15.815
				Fenix laminate	20.403
				Linoleum	20.815
	12322 Four® Standing, 140 x 60, 103 cm	29.1		Decor	12.429
				Laminate	13.446
				Fenix laminate	16.095
				Linoleum	18.294

For tabletop cutout placements go to: Oceedesign.com/Cutout.pdf

Four® Standing

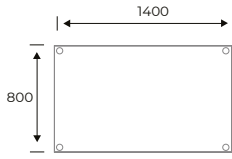
Design by Strand+Hvass

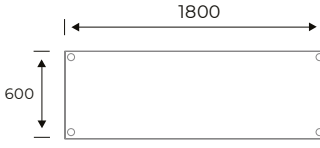
[Content ↗](#)

Product	Description (Item nr)	Weight (Kg)	Dimensions (mm)	Top	Price (SEK)
	12382 Four® Standing, 140 x 80, 103 cm	37.6		Decor	13.775
				Laminate	15.065
				Fenix laminate	18.726
				Linoleum	20.136
	12312 Four® Standing, 180 x 60, 103 cm	35.9		Decor	12.696
				Laminate	14.069
				Fenix laminate	18.420
				Linoleum	19.055
	12392 Four® Standing, 180 x 80, 103 cm	44		Decor	14.069
				Laminate	15.815
				Fenix laminate	20.403
				Linoleum	20.815

For tabletop cutout placements go to: Oceedesign.com/Cutout.pdf





FEATURES

- Table height 51, 64, 72 & 103 cm
- Aluminium pedestal 4 and 5-star base
- Castors to table height 51 cm, 64 cm and 72 cm + 5 cm. in height.
- Matching ABS edges
- Powder coated frame options

For product information visit oceefour.com ↗

TABLE TOP

Decor



Laminate



Fenix laminate



Linoleum



FRAME COLOURS

Standard



Frame optional*



For full colour details [go to page 236](#) ↗











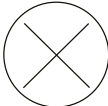

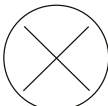







Product	Description (Item nr)	Weight (Kg)	Dimensions (mm)	Top	Price (SEK)
	12240 Four® Resting, Ø 60, 51 cm - 4 Star base	9.3	 Ø 600	Decor	5.103
				Laminate	6.128
				Fenix laminate	7.325
				Linoleum	8.277
	12243 Four® Resting, Ø 60, 64 cm - 4 Star base	9.6	 Ø 600	Decor	5.336
				Laminate	6.370
				Fenix laminate	7.555
				Linoleum	8.518
	12241 Four® Resting, Ø 60, 72,5 cm - 4 Star base	9.9	 Ø 600	Decor	5.336
				Laminate	6.370
				Fenix laminate	7.555
				Linoleum	8.518
	12242 Four® Resting, Ø 60, 103 cm - 4 Star base	10.7	 Ø 600	Decor	5.528
				Laminate	6.559
				Fenix laminate	7.743
				Linoleum	8.718
	12250 Four® Resting, Ø 70, 51 cm - 4 Star base	10.9	 Ø 700	Decor	5.214
				Laminate	6.450
				Fenix laminate	7.937
				Linoleum	8.960

For tabletop cutout placements go to: Ocedesign.com/Cutout.pdf

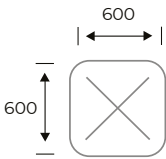
Four® Resting

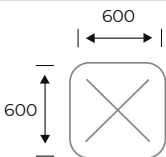
Design by Strand+Hvass

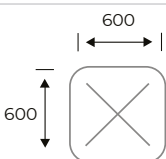
[Content ↗](#)

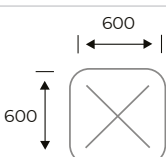









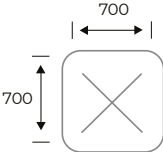

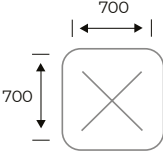

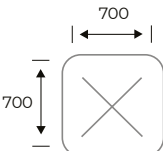

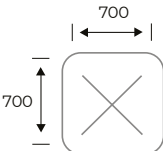

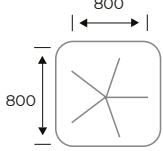

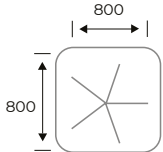
Product	Description (Item nr)	Weight (Kg)	Dimensions (mm)	Top	Price (SEK)
	12253 Four® Resting, Ø 70, 64 cm - 4 Star base	11.2	 Ø 700	Decor	5.466
				Laminate	6.669
				Fenix laminate	8.158
				Linoleum	9.194
	12251 Four® Resting, Ø 70, 72,5 cm - 4 Star base	11.4	 Ø 700	Decor	5.466
				Laminate	6.669
				Fenix laminate	8.158
				Linoleum	9.194
	12252 Four® Resting, Ø 70, 103 cm - 4 Star base	12.2	 Ø 700	Decor	5.647
				Laminate	6.871
				Fenix laminate	8.349
				Linoleum	9.384
	12265 Four® Resting, Ø 80, 51 cm - 5 Star base	12.9	 Ø 800	Decor	5.365
				Laminate	6.792
				Fenix laminate	8.607
				Linoleum	9.323
	12268 Four® Resting, Ø 80, 64 cm - 5 Star base	13.2	 Ø 800	Decor	5.594
				Laminate	7.025
				Fenix laminate	8.830
				Linoleum	9.545
	12266 Four® Resting, Ø 80, 72,5 cm - 5 Star base	13.4	 Ø 800	Decor	5.594
				Laminate	7.025
				Fenix laminate	8.830
				Linoleum	9.545
	12267 Four® Resting, Ø 80, 103 cm - 5 Star base	14.2	 Ø 800	Decor	5.807
				Laminate	7.212
				Fenix laminate	9.029
				Linoleum	9.747
	12230 Four® Resting, 60 x 60, 51 cm - 4 Star base	-	 600 x 600	Decor	5.103
				Laminate	6.128
				Fenix laminate	7.325
				Linoleum	8.277
	12233 Four® Resting, 60 x 60, 64 cm - 4 Star base	10.7	 600 x 600	Decor	5.336
				Laminate	6.370
				Fenix laminate	7.555
				Linoleum	8.518
	12231 Four® Resting, 60 x 60, 72,5 cm - 4 Star base	11	 600 x 600	Decor	5.336
				Laminate	6.370
				Fenix laminate	7.555
				Linoleum	8.518
	12232 Four® Resting, 60 x 60, 103 cm - 4 Star base	11.8	 600 x 600	Decor	5.528
				Laminate	6.559
				Fenix laminate	7.743
				Linoleum	8.718

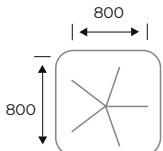
For tabletop cutout placements go to: [Oceedesign.com/Cutout.pdf](https://oceedesign.com/Cutout.pdf)

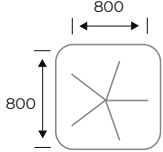
Four® Resting

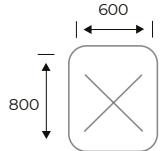
Design by Strand+Hvass

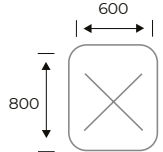
[Content ↗](#)

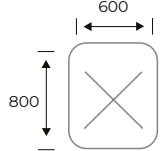
Product	Description (Item nr)	Weight (Kg)	Dimensions (mm)	Top	Price (SEK)
	12200 Four® Resting, 70 x 70, 51 cm - 4 Star base	-		Decor	5.214
				Laminate	6.450
				Fenix laminate	7.937
				Linoleum	8.960
	12203 Four® Resting, 70 x 70, 64 cm - 4 Star base	-		Decor	5.466
				Laminate	6.669
				Fenix laminate	8.158
				Linoleum	9.194
	12201 Four® Resting, 70 x 70, 72,5 cm - 4 Star base	13		Decor	5.466
				Laminate	6.669
				Fenix laminate	8.158
				Linoleum	9.194
	12202 Four® Resting, 70 x 70, 103 cm - 4 Star base	13.8		Decor	5.647
				Laminate	6.871
				Fenix laminate	8.349
				Linoleum	9.384
	12215 Four® Resting, 80 x 80, 51 cm - 5 Star base	15		Decor	5.365
				Laminate	6.792
				Fenix laminate	8.607
				Linoleum	9.323
	12218 Four® Resting, 80 x 80, 64 cm - 5 Star base	15.2		Decor	5.594
				Laminate	7.025
				Fenix laminate	8.830
				Linoleum	9.545
	12216 Four® Resting, 80 x 80, 72,5 cm - 5 Star base	15.5		Decor	5.594
				Laminate	7.025
				Fenix laminate	8.830
				Linoleum	9.545
	12217 Four® Resting, 80 x 80, 103 cm - 5 Star base	16.3		Decor	5.807
				Laminate	7.212
				Fenix laminate	9.029
				Linoleum	9.747
	12220 Four® Resting, 80 x 60, 51 cm - 4 Star base	12.3		Decor	5.214
				Laminate	6.450
				Fenix laminate	7.925
				Linoleum	8.578
	12223 Four® Resting, 80 x 60, 64 cm - 4 Star base	12.6		Decor	5.466
				Laminate	6.669
				Fenix laminate	8.146
				Linoleum	8.821
	12221 Four® Resting, 80 x 60, 72,5 cm - 4 Star base	12.8		Decor	5.466
				Laminate	6.669
				Fenix laminate	8.146
				Linoleum	8.821

For tabletop cutout placements go to: Ocedesign.com/Cutout.pdf

Four® Resting

Design by Strand+Hvass

[Content ↗](#)

Product	Description (Item nr)	Weight (Kg)	Dimensions (mm)	Top	Price (SEK)
	12222 Four® Resting, 80 x 60, 103 cm - 4 Star base	-		Decor	5.655
				Laminate	6.861
				Fenix laminate	8.357
				Linoleum	9.001

For tabletop cutout placements go to: [Oceedesign.com/Cutout.pdf](https://oceedesign.com/Cutout.pdf)

ACCESSORIES	Description	Weight (Kg)	Dimensions (mm)	Price (SEK)
	CHAIR FEET Castors			651
	CHAIR FEET Felt glides, set of 4 pcs. height + 0,2 cm	1,82 g x 4		208
	FLIP TOP With Flip Top			2.730

SURCHARGE		Price (SEK)
FRAME OPTIONAL	 B C K	1075

Y-Table

Design by Osko + Deichmann

[Content ↗](#)



FEATURES

- Height adjustable
- Fold-away allows for nesting storage
- Designed for disassembly at end of life
- Cable management hook
- Height lever doubles up as a handle for portability
- Designed to complement products across all our families
- Tested according to EN 16139, L2 and EN15372 for stability

For product information visit oceefour.com ↗

TABLE TOP

Fenix laminate



09

FRAME COLOURS

Standard



B

For full colour details [go to page 236](#) ↗

Product	Description (Item nr)	Weight (Kg)	Dimensions (mm)	Top	Price (SEK)
	ATYT63 Y-Table, 46 cm x 33 cm	4.6		Fenix laminate	4.103





FourPeople Stand Alone



FourPeople Stand Alone for panels



FourPeople Modules



FourPeople Modules for panels



FourPeople Stand alone panels



FourPeople Add on panels



FourPeople Work Booth



FourPeople Study Booth



FourPeople Work Hut



FourPeople Sofa Hut

FourPeople Stand Alone

Design by Nørgaard Design

[Content ↗](#)

Configuration Example 1

2 seater
Low back with armrest



1 seater
Low back



2 seater
Low back



3 seater
Low back



Pouf

FourPeople Stand Alone

Design by Nørgaard Design

[Content ↗](#)



FEATURES



- Soft seating range with low back and high back options.
- The range includes one, two, three seater sofas and Pouffe.
- Two tone fabric options available & armrest option.
- Electrical units are optional and will be positioned on the left or right side of sofas as standard.
- Leg and frame in black (RAL7021).
- Upholstery available in various fabrics. For recommendations, please contact your sales representative.

For product information visit oceefour.com ↗

For electrical accessories [go to page 228](#) ↗





For full band and colour details [go to page 338](#) ↗

Product	Description (Item nr)	Weight (Kg)	Dimensions (mm)	Band	Same colour (SEK)	Different seat colour (SEK)
	PEF1L FourPeople Stand Alone, 1 Seater, Low back			1 2 3 4 5 6 7	12.040 12.490 12.962 13.983 14.455 14.807 16.021	2.409 2.498 2.592 2.796 2.891 2.962 3.205
	PEF1H FourPeople Stand Alone, 1 Seater, High back			1 2 3 4 5 6 7	13.861 14.407 14.990 16.264 16.847 17.284 18.788	2.409 2.498 2.592 2.796 2.891 2.962 3.474
	PEF2L FourPeople Stand Alone, 2 Seater, Low back			1 2 3 4 5 6 7	18.885 19.225 19.809 21.083 21.665 22.102 23.607	3.777 3.846 3.962 4.217 4.333 4.421 4.722
	PEF2H FourPeople Stand Alone, 2 Seater, High back			1 2 3 4 5 6 7	21.629 22.539 23.510 25.610 26.580 27.296 29.773	3.777 3.846 3.962 4.217 4.333 4.421 4.722

FourPeople Stand Alone

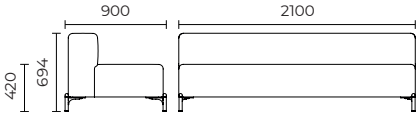
[Content ↗](#)

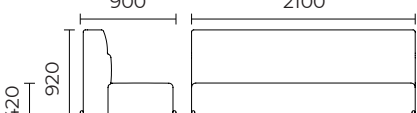
Design by Nørgaard Design

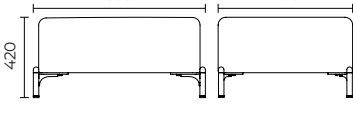
Product	Description (Item nr)	Weight (Kg)	Dimensions (mm)	Band	Same colour (SEK)	Different seat colour (SEK)
	PEF3L FourPeople Stand Alone, 3 Seater, Low back			1 2 3 4 5 6 7	26.957 27.976 29.057 31.399 32.479 33.280 36.047	5.392 5.595 5.811 6.280 6.496 6.657 7.210
	PEF3H FourPeople Stand Alone, 3 Seater, High back			1 2 3 4 5 6 7	31.242 32.491 33.827 36.703 38.025 39.009 42.420	5.392 5.595 5.811 6.280 6.496 6.657 7.210
	PEFP0 FourPeople Stand Alone, Pouf			1 2 3 4 5 6 7	9.795 10.147 10.535 11.361 11.748 12.028 13.011	

ACCESSORIES	Description	Weight (Kg)	Dimensions (mm)	Band	Price (SEK)
	Set of armrests		800 x 486 x 134 mm	1 2 3 4 5 6 7	3.568 4.170 4.825 6.209 6.847 7.318 8.976
	FOURPEOPLE TRAY ACC1002	1,8 kg			478



FourPeople Stand Alone for Panels

[Content ↗](#)

Design by Nørgaard Design

Configuration Example 1

2 seater low back with
back panel with straps,
H1020



1 seater
Low back



2 seater
Low back



3 seater
Low back



Open Panel

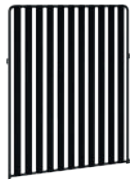

Panel with straps

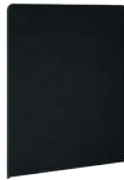

Panel with fabric



Panel Fabric
with Acoustic

FourPeople Stand Alone for panels

[Content ↗](#)

Design by Nørgaard Design



FEATURES





- Soft seating range with panels. The range includes one, two and three seater sofas.
- Two tone fabric options available.
- A wide selection of panels in a range of heights and widths.
- Panel Options: Open panel, Panel with straps, Fabric Panel, Fabric Panel with Acoustic Filling.
- Armrest option (cannot combine armrest and side panels on the same side).
- Electrical units are optional and will be positioned on the left or right side of sofas as standard.
- Upholstery available in various fabrics. For recommendations, please contact your sales representative.

For product information visit oceefour.com ↗

For electrical accessories [go to page 228](#) ↗

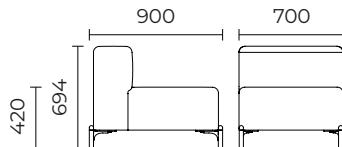
For full band and colour details [go to page 238](#) ↗

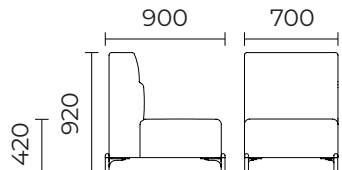

Product	Description (Item nr)	Weight (Kg)	Dimensions (mm)	Band	Same colour (SEK)	Different seat colour (SEK)
	PEE1L FourPeople Stand Alone for back panel, 1 Seater, Low back			1 2 3 4 5 6 7	12.040 12.490 12.962 13.983 14.455 14.807 16.021	2.409 2.498 2.592 2.796 2.891 2.962 3.205
	PEE1H FourPeople Stand Alone for back panel, 1 Seater, High back			1 2 3 4 5 6 7	13.861 14.407 14.990 16.264 16.847 17.284 18.788	2.409 2.498 2.592 2.796 2.891 2.962 3.474

FourPeople Stand Alone for panels

Content ↗

Design by Nørgaard Design

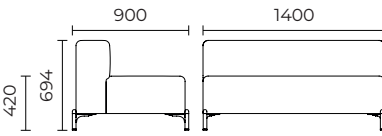
SURCHARGE	Open panel		Panel / Straps		Panel / Fabric			Acoustic		Armrest
	Back	1 x Side	Back	1 x Side	Band	Back	1 x Side	Back	1 x Side	1 x
H: 1020	3.447	4.224	4.321	5.390	1	4.006	4.928	4.905	6.129	1.784
					2	4.346	5.353	5.244	6.554	2.085
					3	4.710	5.802	5.609	7.003	2.413
					4	5.487	6.784	6.385	7.985	3.105
					5	5.851	7.233	6.750	8.435	3.424
					6	6.117	7.561	7.016	8.762	3.659
					7	7.040	8.714	7.939	9.916	4.488
H: 1370	5.692	6.579	6.590	7.780	1	6.264	7.283	7.477	8.618	1.784
					2	6.603	7.709	7.817	9.044	2.085
					3	6.955	8.157	8.169	9.492	2.413
					4	7.744	9.140	8.958	10.476	3.105
					5	8.096	9.590	9.310	10.925	3.424
					6	8.364	9.917	9.577	11.253	3.659
					7	9.285	11.070	10.499	12.406	4.488
H: 1720	5.936	6.676	6.870	7.805	1	6.750	7.624	9.080	9.954	1.784
					2	7.235	8.266	9.565	10.596	2.085
					3	7.757	8.933	10.087	11.264	2.413
					4	8.873	10.403	11.203	12.733	3.105
					5	9.395	11.070	11.725	13.400	3.424
					6	9.772	11.580	12.102	13.910	3.659
					7	11.106	13.303	13.436	15.633	4.488

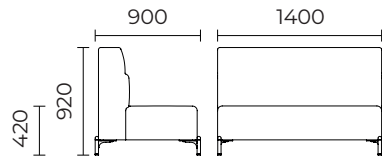

Product	Description (Item nr)	Weight (Kg)	Dimensions (mm)	Band	Same colour (SEK)	Different seat colour (SEK)
	PEE2L FourPeople Stand Alone for back panel, 2 Seater, Low back			1	18.885	3.777
				2	19.225	3.846
				3	19.809	3.962
				4	21.083	4.217
				5	21.665	4.333
				6	22.102	4.421
				7	23.607	4.722
	PEE2H FourPeople Stand Alone for back panel, 2 Seater, High back			1	21.629	3.777
				2	22.539	3.846
				3	23.510	3.962
				4	25.610	4.217
				5	26.580	4.333
				6	27.296	4.421
				7	29.773	4.722

SURCHARGE	Open panel		Panel / Straps		Panel / Fabric			Acoustic		Armrest
	Back	1 x Side	Back	1 x Side	Band	Back	1 x Side	Back	1 x Side	1 x
H: 1020	3.994	4.224	5.936	5.390	1	5.014	4.929	7.332	6.131	1.784
					2	5.633	5.354	7.951	6.555	2.085
					3	6.288	5.803	8.606	7.005	2.413
					4	7.696	6.785	10.014	7.987	3.105
					5	8.351	7.235	10.669	8.436	3.424
					6	8.837	7.562	11.155	8.764	3.659
					7	10.511	8.716	12.829	9.917	4.488
H: 1370	6.410	6.580	8.351	7.781	1	7.442	7.283	9.796	8.618	1.784
					2	8.048	7.709	10.403	9.044	2.085
					3	8.703	8.157	11.058	9.492	2.413
					4	10.111	9.140	12.466	10.476	3.105
					5	10.766	9.590	13.121	10.925	3.424
					6	11.253	9.917	13.607	11.253	3.659
					7	12.927	11.070	15.281	12.406	4.488
H: 1720	6.676	6.676	8.703	7.805	1	8.206	7.624	12.733	9.954	1.784
					2	9.116	8.266	13.643	10.596	2.085
					3	10.074	8.933	14.602	11.264	2.413
					4	12.174	10.403	16.702	12.733	3.105
					5	13.144	11.070	17.672	13.400	3.424
					6	13.861	11.580	18.388	13.910	3.659
					7	16.348	13.303	20.876	15.633	4.488

FourPeople Stand Alone for panels

[Content](#) ↗

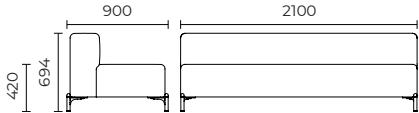
Design by Nørgaard Design

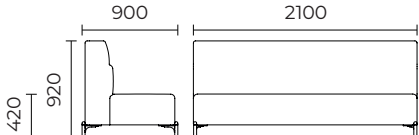
Product	Description (Item nr)	Weight (Kg)	Dimensions (mm)	Band	Same colour (SEK)	Different seat colour (SEK)
	PEE3L FourPeople Stand Alone for back panel, 3 Seater, Low back			1	26.957	5.392
				2	27.976	5.595
				3	29.057	5.811
				4	31.399	6.280
				5	32.479	6.496
				6	33.280	6.657
				7	36.047	7.210
	PEE3H FourPeople Stand Alone for back panel, 3 Seater, High back			1	31.242	5.392
				2	32.491	5.595
				3	33.827	5.811
				4	36.703	6.280
				5	38.025	6.496
				6	39.009	6.657
				7	42.420	7.210

SURCHARGE	Open panel		Panel / Straps		Panel / Fabric			Acoustic		Armrest
	Panel height	Back	1 x Side	Back	1 x Side	Band	Back	1 x Side	Back	1 x Side
H: 1020	4.322	4.225	8.121	5.390	1	6.725	4.929	9.310	6.131	1.784
					2	7.635	5.354	10.220	6.555	2.085
					3	8.594	5.803	11.179	7.005	2.413
					4	10.694	6.785	13.279	7.987	3.105
					5	11.665	7.235	14.250	8.436	3.424
					6	12.381	7.562	14.966	8.764	3.659
					7	14.869	8.716	17.454	9.917	4.488
H: 1370	7.539	6.580	10.524	7.781	1	9.055	7.283	13.618	8.618	1.784
					2	9.966	7.709	14.529	9.044	2.085
					3	10.924	8.157	15.487	9.492	2.413
					4	13.024	9.140	17.587	10.476	3.105
					5	13.995	9.590	18.558	10.925	3.424
					6	14.711	9.917	19.274	11.253	3.659
					7	17.199	11.070	21.762	12.406	4.488
H: 1720	4.147	6.676	10.646	7.805	1	9.796	7.624	14.409	9.954	1.784
					2	11.155	8.266	15.768	10.596	2.085
					3	12.587	8.933	17.199	11.264	2.413
					4	15.706	10.403	20.318	12.733	3.105
					5	17.151	11.070	21.764	13.400	3.424
					6	18.218	11.580	22.831	13.910	3.659
					7	21.921	13.303	26.533	15.633	4.488

ACCESSORIES	Description	Weight (Kg)	Dimensions (mm)	Band	Price (SEK)
	FOURPEOPLE TRAY ACC1002	1,8 kg			478
	FOURPEOPLE HOOK ACC1001	0,1 kg			126

FourPeople Modules

Design by Nørgaard Design





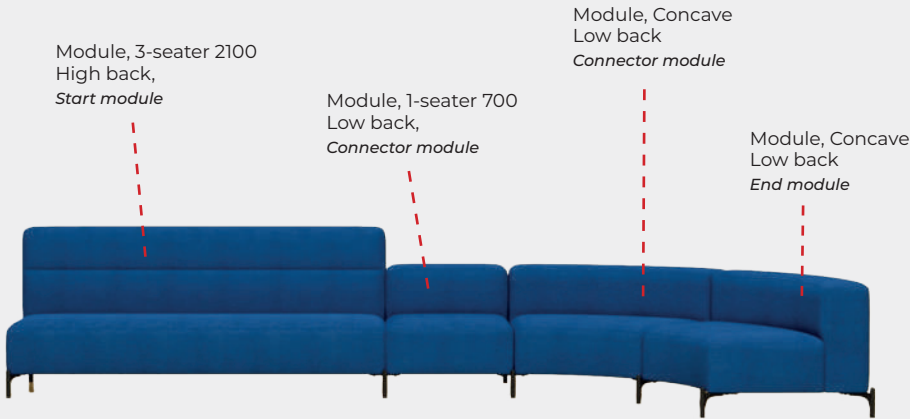















Configuration Example 1



FourPeople Modules

Design by Nørgaard Design

Modules overview

	Start	Connector	End
1 seater			
2 seater			
3 seater			
Convex			
Concave			
Pouffe			
Corner			

FourPeople Modules

Design by Nørgaard Design

[Content ↗](#)



FEATURES



- Multifunctional modular soft seating range.
- The range includes one, two & three seater modules; convex, concave & corner modules; and pouffe.
- The price is the same if it's a start, connector or an end module.
- Two tone fabric options available & armrest option.
- Electrical units are optional and will be positioned on the left or right side of sofas as standard.
- Leg and frame in black (RAL7021).
- Upholstery available in various fabrics. For recommendations, please contact your sales representative.

For product information visit oceefour.com ↗

For electrical accessories [go to page 228](#) ↗











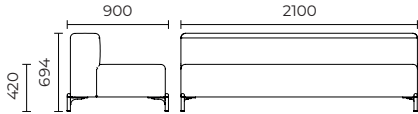

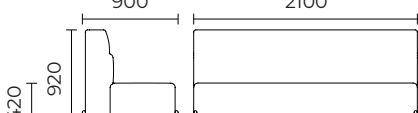

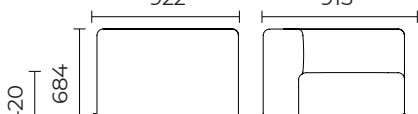

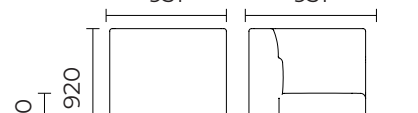
For full band and colour details [go to page 238](#) ↗

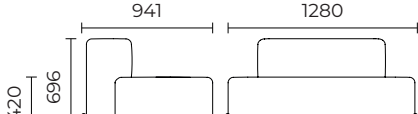
Product	Description (Item nr)	Weight (Kg)	Dimensions (mm)	Band	Same colour (SEK)	Different seat colour (SEK)
	PEC1 FourPeople Modules - Low back, 1 Seater			1 2 3 4 5 6 7	12.040 12.490 12.962 13.983 14.455 14.807 16.021	2.409 2.498 2.592 2.796 2.891 2.962 3.205
	PED1 FourPeople Modules - High back, 1 Seater			1 2 3 4 5 6 7	13.861 14.407 14.990 16.264 16.847 17.284 18.788	2.409 2.498 2.592 2.796 2.891 2.962 3.474
	PEC2 FourPeople Modules - Low back, 2 Seater			1 2 3 4 5 6 7	18.885 19.225 19.809 21.083 21.665 22.102 23.607	3.777 3.846 3.962 4.217 4.333 4.421 4.722
	PED2 FourPeople Modules - High back, 2 Seater			1 2 3 4 5 6 7	21.629 22.539 23.510 25.610 26.580 27.296 29.773	3.777 3.846 3.962 4.217 4.333 4.421 4.722

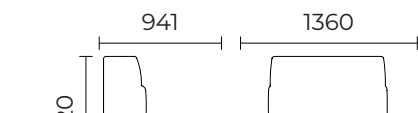
FourPeople Modules

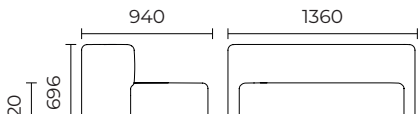
Design by Nørgaard Design

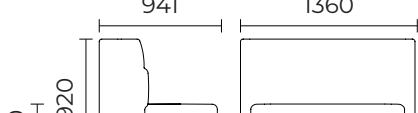
[Content](#) ↗

Product	Description (Item nr)	Weight (Kg)	Dimensions (mm)	Band	Same colour (SEK)	Different seat colour (SEK)
	PEC3 FourPeople Modules - Low back, 3 Seater			1 2 3 4 5 6 7	26.957 27.976 29.057 31.399 32.479 33.280 36.047	5.392 5.595 5.811 6.280 6.496 6.657 7.210
	PED3 FourPeople Modules - High back, 3 Seater			1 2 3 4 5 6 7	31.242 32.491 33.827 36.703 38.025 39.009 42.420	5.392 5.595 5.811 6.280 6.496 6.657 7.210
	PECC FourPeople Modules - Low back, Corner 90°			1 2 3 4 5 6 7	18.303 19.032 19.796 21.447 22.211 22.783 24.748	3.661 3.807 3.959 4.290 4.443 4.557 4.950
	PEDC FourPeople Modules - High back, Corner 90°			1 2 3 4 5 6 7	22.394 23.365 24.396 26.642 27.673 28.450 31.109	3.661 3.807 3.959 4.290 4.443 4.557 4.950
	PECV FourPeople Modules - Low back, Convex			1 2 3 4 5 6 7	18.485 19.080 19.711 21.070 21.702 22.176 23.790	3.698 3.817 3.943 4.214 4.340 4.436 4.758
	PEDV FourPeople Modules - High back, Convex			1 2 3 4 5 6 7	21.035 21.884 22.783 24.736 25.635 26.302 28.614	3.698 3.817 3.943 4.214 4.340 4.436 4.758
	PECA FourPeople Modules - Low back, Concave			1 2 3 4 5 6 7	19.190 19.888 20.633 22.242 22.983 23.535 25.440	3.839 3.979 4.127 4.448 4.596 4.707 5.088
	PEDA FourPeople Modules - High back, Concave			1 2 3 4 5 6 7	22.795 23.668 24.591 26.587 27.510 28.195 30.562	3.839 3.979 4.127 4.448 4.596 4.707 5.088
	PECP FourPeople Modules - Low back, Pouf			1 2 3 4 5 6 7	9.795 10.147 10.535 11.361 11.748 12.028 13.011	

FourPeople Modules

Design by Nørgaard Design

[Content ↗](#)

ACCESSORIES	Description	Weight (Kg)	Dimensions (mm)	Band	Price (SEK)
	armrest		800 x 486 x 134 mm	1	1.784
				2	2.085
				3	2.413
				4	3.105
				5	3.424
				6	3.659
				7	4.488
	FOURPEOPLE TRAY ACC1002	1,8 kg			478



FourPeople Modules for Panels

Design by Nørgaard Design

[Content ↗](#)

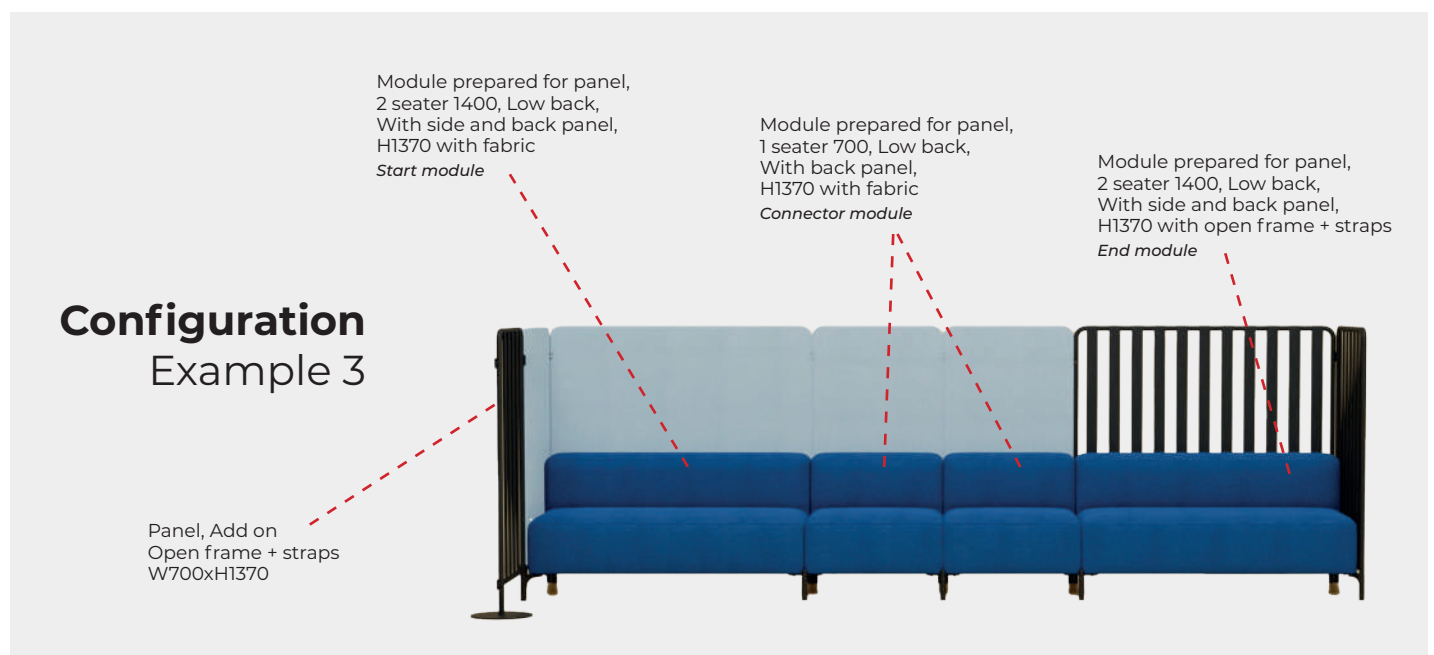

Modules overview

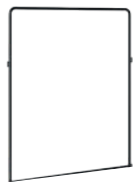
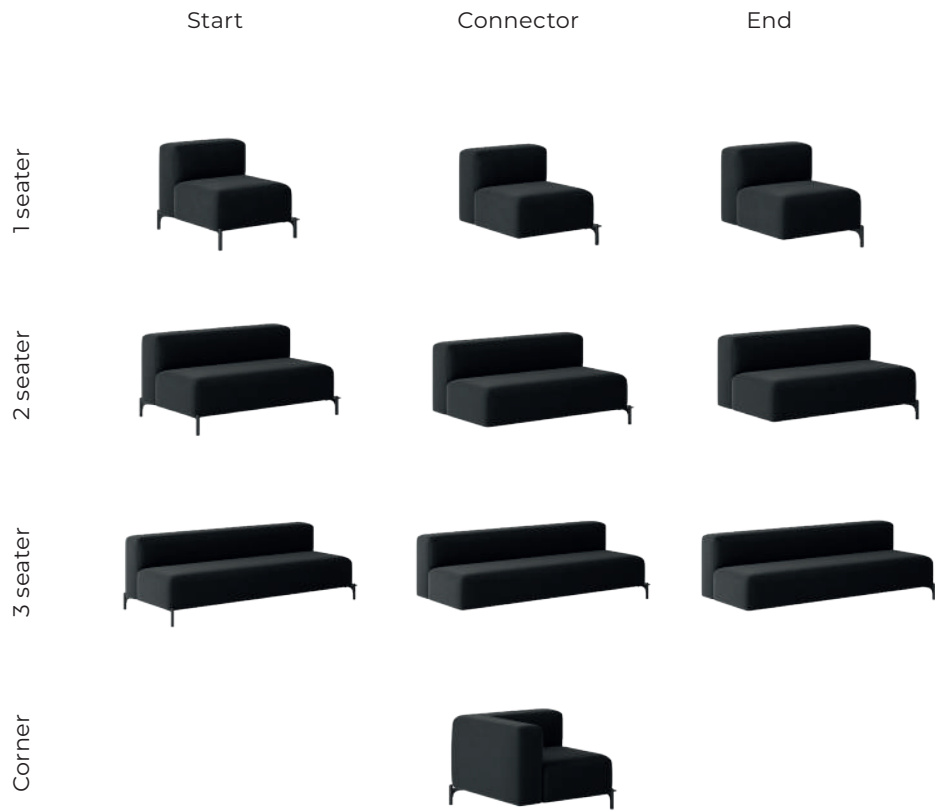

Open Panel

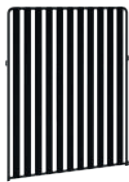

Panel with straps

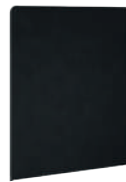

Panel with fabric



Panel Fabric with Acoustic

FourPeople Modules for panels

Design by Nørgaard Design

[Content ↗](#)



FEATURES



- Multifunctional modular soft seating range with panels. As a standard, modules with or without panels cannot be connected.
- All modules can have panels on the back and side at the same time. Modules cannot have just a side panel. (two sides available for start module).
- The price is the same if it's a start, connector or an end module.
- Panel Options: Open panel, Panel with straps, Fabric Panel, Fabric Panel with Acoustic Filling.
- Armrest option (cannot combine armrest and side panels on the same side).
- Two tone fabric options available.
- Electrical units are optional and will be positioned on the left or right side of sofas as standard.
- Leg and frame in black (RAL7021).
- Upholstery available in various fabrics. For recommendations, please contact your sales representative.

For product information visit oceefour.com ↗

For electrical accessories [go to page 228](#) ↗

For full band and colour details [go to page 238](#) ↗



Product	Description (Item nr)	Weight (Kg)	Dimensions (mm)	Band	Same colour (SEK)	Different seat colour (SEK)
	PEA1 FourPeople Modules low back for back panel, 1 Seater			1 2 3 4 5 6 7	12.040 12.490 12.962 13.983 14.455 14.807 16.021	2.409 2.498 2.592 2.796 2.891 2.962 3.205
	PEB1 FourPeople Modules high back for back panel, 1 Seater			1 2 3 4 5 6 7	13.861 14.407 14.990 16.264 16.847 17.284 18.788	2.409 2.498 2.592 2.796 2.891 2.962 3.474

FourPeople Modules for panels

[Content](#) ↗

Design by Nørgaard Design

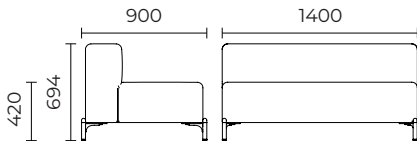
SURCHARGE	Open panel		Panel / Straps		Panel / Fabric			Acoustic		Armrest
	Back	1 x Side	Back	1 x Side	Band	Back	1 x Side	Back	1 x Side	1 x
H: 1020	3.447	4.224	4.321	5.390	1	4.006	4.929	4.905	6.131	1.784
					2	4.346	5.354	5.244	6.555	2.085
					3	4.710	5.803	5.609	7.005	2.413
					4	5.487	6.785	6.385	7.987	3.105
					5	5.851	7.235	6.750	8.436	3.424
					6	6.117	7.562	7.016	8.764	3.659
					7	7.040	8.716	7.939	9.917	4.488
H: 1370	5.694	6.580	6.591	7.781	1	6.264	7.283	7.477	8.618	1.784
					2	6.603	7.709	7.817	9.044	2.085
					3	6.955	8.157	8.169	9.492	2.413
					4	7.744	9.140	8.958	10.476	3.105
					5	8.096	9.590	9.310	10.925	3.424
					6	8.364	9.917	9.577	11.253	3.659
					7	9.285	11.070	10.499	12.406	4.488
H: 1720	5.936	6.676	6.870	7.805	1	6.750	7.624	9.080	9.954	1.784
					2	7.235	8.266	9.565	10.596	2.085
					3	7.757	8.933	10.087	11.264	2.413
					4	8.873	10.403	11.203	12.733	3.105
					5	9.395	11.070	11.725	13.400	3.424
					6	9.772	11.580	12.102	13.910	3.659
					7	11.106	13.303	13.436	15.633	4.488

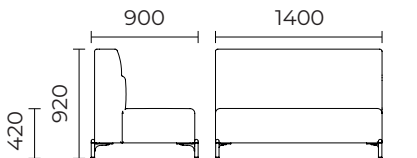

Product	Description (Item nr)	Weight (Kg)	Dimensions (mm)	Band	Same colour (SEK)	Different seat colour (SEK)
	PEA2 FourPeople Modules low back for back panel, 2 Seater			1	18.885	3.777
				2	19.225	3.846
				3	19.809	3.962
				4	21.083	4.217
				5	21.665	4.333
				6	22.102	4.421
				7	23.607	4.722
	PEB2 FourPeople Modules high back for back panel, 2 Seater			1	21.629	3.777
				2	22.539	3.846
				3	23.510	3.962
				4	25.610	4.217
				5	26.580	4.333
				6	27.296	4.421
				7	29.773	4.722

SURCHARGE	Open panel		Panel / Straps		Panel / Fabric			Acoustic		Armrest
	Back	1 x Side	Back	1 x Side	Band	Back	1 x Side	Back	1 x Side	1 x
H: 1020	3.994	4.224	5.936	5.390	1	5.014	4.929	7.332	6.131	1.784
					2	5.633	5.354	7.951	6.555	2.085
					3	6.288	5.803	8.606	7.005	2.413
					4	7.696	6.785	10.014	7.987	3.105
					5	8.351	7.235	10.669	8.436	3.424
					6	8.837	7.562	11.155	8.764	3.659
					7	10.511	8.716	12.829	9.917	4.488
H: 1370	6.410	6.580	8.351	7.781	1	7.442	7.283	9.796	8.618	1.784
					2	8.048	7.709	10.403	9.044	2.085
					3	8.703	8.157	11.058	9.492	2.413
					4	10.111	9.140	12.466	10.476	3.105
					5	10.766	9.590	13.121	10.925	3.424
					6	11.253	9.917	13.607	11.253	3.659
					7	12.927	11.070	15.281	12.406	4.488
H: 1720	6.676	6.676	8.703	7.805	1	8.206	7.624	12.733	9.954	1.784
					2	9.116	8.266	13.643	10.596	2.085
					3	10.074	8.933	14.602	11.264	2.413
					4	12.174	10.403	16.702	12.733	3.105
					5	13.144	11.070	17.672	13.400	3.424
					6	13.861	11.580	18.388	13.910	3.659
					7	16.348	13.303	20.876	15.633	4.488

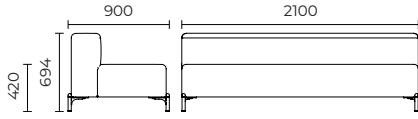

FourPeople Modules for panels

[Content ↗](#)

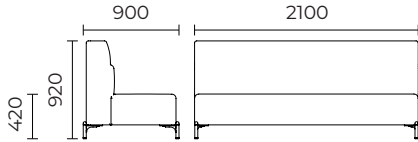
Design by Nørgaard Design

Product	Description (Item nr)	Weight (Kg)	Dimensions (mm)	Band	Same colour (SEK)	Different seat colour (SEK)
	PEA3 FourPeople Modules low back for back panel, 3 Seater			1 2 3 4 5 6 7	26.957 27.976 29.057 31.399 32.479 33.280 36.047	5.392 5.595 5.811 6.280 6.496 6.657 7.210
	PEB3 FourPeople Modules high back for back panel, 3 Seater			1 2 3 4 5 6 7	31.242 32.491 33.827 36.703 38.025 39.009 42.420	5.392 5.595 5.811 6.280 6.496 6.657 7.210

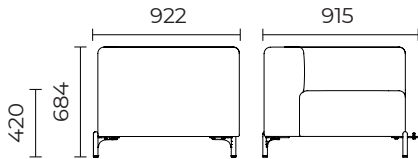
SURCHARGE	Open panel		Panel / Straps		Panel / Fabric			Acoustic		Armrest
	Back	1 x Side	Back	1 x Side	Band	Back	1 x Side	Back	1 x Side	1 x
Panel height										
H: 1020	4.322	4.225	8.121	5.390	1 2 3 4 5 6 7	6.725 7.635 8.594 10.694 11.665 12.381 14.869	4.929 5.354 5.803 6.785 7.235 7.562 8.716	9.310 10.220 11.179 13.279 14.250 14.966 17.454	6.131 6.555 7.005 7.987 8.436 8.764 9.917	1.784 2.085 2.413 3.105 3.424 3.659 4.488
H: 1370	7.539	6.580	10.524	7.781	1 2 3 4 5 6 7	9.055 9.966 10.924 13.024 13.995 14.711 17.199	7.283 7.709 8.157 9.140 9.590 9.917 11.070	13.618 14.529 15.487 17.587 18.558 19.274 21.762	8.618 9.044 9.492 10.476 10.925 11.253 12.406	1.784 2.085 2.413 3.105 3.424 3.659 4.488
H: 1720	4.147	6.676	10.646	7.805	1 2 3 4 5 6 7	9.796 11.155 12.587 15.706 17.151 18.218 21.921	7.624 8.266 8.933 10.403 11.070 11.580 13.303	14.409 15.768 17.199 20.318 21.764 22.831 26.533	9.954 10.596 11.264 12.733 13.400 13.910 15.633	1.784 2.085 2.413 3.105 3.424 3.659 4.488

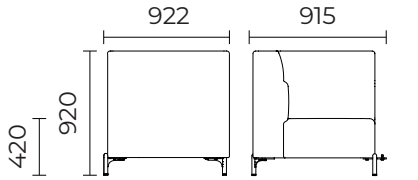
Product	Description (Item nr)	Weight (Kg)	Dimensions (mm)	Band	Same colour (SEK)	Different seat colour (SEK)
	PEAC FourPeople Modules low back for back panel, Corner 90°			1 2 3 4 5 6 7	18.303 19.032 19.796 21.447 22.211 22.783 24.748	3.661 3.807 3.959 4.290 4.443 4.557 4.950
	PEBC FourPeople Modules high back for back panel, Corner 90°			1 2 3 4 5 6 7	22.394 23.365 24.396 26.642 27.673 28.450 31.109	3.661 3.807 3.959 4.290 4.443 4.557 4.950

FourPeople Modules for panels

[Content](#) ↗

Design by Nørgaard Design

SURCHARGE	Open panel		Panel / Straps		Panel / Fabric			Acoustic		Armrest
	Panel height	Back	1 x Side	Back	1 x Side	Band	Back	1 x Side	Back	1 x Side
H: 1020	4.224	4.224	5.390	5.390	1	4.929	4.929	6.131	6.131	1.784
					2	5.354	5.354	6.555	6.555	2.085
					3	5.803	5.803	7.005	7.005	2.413
					4	6.785	6.785	7.987	7.987	3.105
					5	7.235	7.235	8.436	8.436	3.424
					6	7.562	7.562	8.764	8.764	3.659
					7	8.716	8.716	9.917	9.917	4.488
H: 1370	6.580	6.580	7.781	7.781	1	7.283	7.283	8.618	8.618	1.784
					2	7.709	7.709	9.044	9.044	2.085
					3	8.157	8.157	9.492	9.492	2.413
					4	9.140	9.140	10.476	10.476	3.105
					5	9.590	9.590	10.925	10.925	3.424
					6	9.917	9.917	11.253	11.253	3.659
					7	11.070	11.070	12.406	12.406	4.488
H: 1720	6.676	6.676	7.805	7.805	1	7.624	7.624	9.954	9.954	1.784
					2	8.266	8.266	10.596	10.596	2.085
					3	8.933	8.933	11.264	11.264	2.413
					4	10.403	10.403	12.733	12.733	3.105
					5	11.070	11.070	13.400	13.400	3.424
					6	11.580	11.580	13.910	13.910	3.659
					7	13.303	13.303	15.633	15.633	4.488

ACCESSORIES	Description	Weight (Kg)	Dimensions (mm)	Band	Price (SEK)
	FOURPEOPLE TRAY ACC1002	1,8 kg			478
	FOURPEOPLE HOOK ACC1001	0,1 kg			126

FourPeople Stand alone panels

Design by Nørgaard Design

[Content](#) ↗









FEATURES

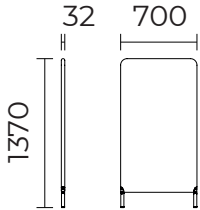

- Panel Options: Open panel, Panel with straps, Fabric Panel, Fabric Panel with Acoustic Filling
- Offer acoustic and visual privacy
- Leg and frame in black (RAL7021)
- Diameter of foot 30 cm
- Upholstery available in various fabrics. For recommendations, please contact your sales representative

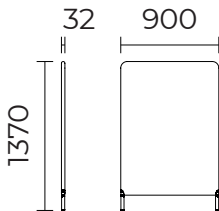
For product information visit oceefour.com ↗

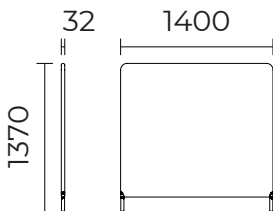

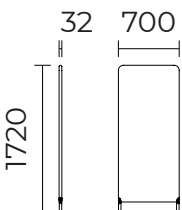







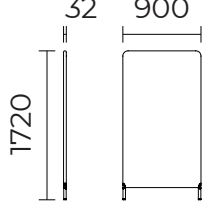

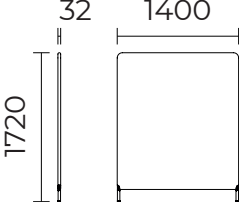
For full band and colour details [go to page 238](#) ↗

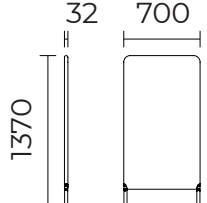
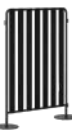
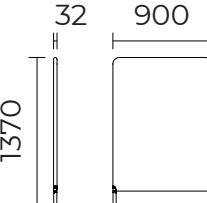
Product	Description (Item nr)	Weight (Kg)	Dimensions (mm)	Band	Standard (SEK)
	PEG1131 FourPeople Panel, Stand alone, W: 700, H: 1370, Frame	-		-	9.250
	PEG1231 FourPeople Panel, Stand alone, W: 900, H: 1370, Frame	-		-	9.455
	PEG1331 FourPeople Panel, Stand alone, W: 1400, H: 1370, Frame	-		-	9.966
	PEG1141 FourPeople Panel, Stand alone, W: 700, H: 1720, Frame	-		-	9.492

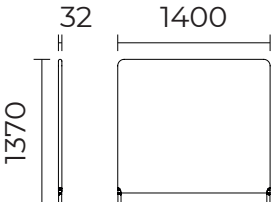
FourPeople Stand alone panels

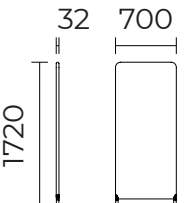
[Content ↗](#)

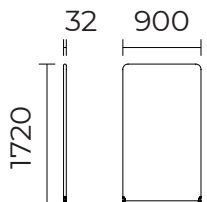

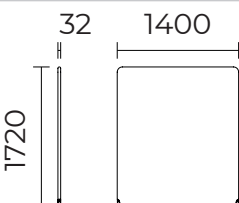

Design by Nørgaard Design

Product	Description (Item nr)	Weight (Kg)	Dimensions (mm)	Band	Standard (SEK)
	PEG1241 FourPeople Panel, Stand alone, W: 900, H: 1720, Frame	-		-	9.553
	PEG1341 FourPeople Panel, Stand alone, W: 1400, H: 1720, Frame	-		-	10.232
	PEG1132 FourPeople Panel, Stand alone, W: 700, H: 1370, Straps	-		-	10.147
	PEG1232 FourPeople Panel, Stand alone, W: 900, H: 1370, Straps	-		-	10.646
	PEG1332 FourPeople Panel, Stand alone, W: 1400, H: 1370, Straps	-		-	11.907
	PEG1142 FourPeople Panel, Stand alone, W: 700, H: 1720, Straps	-		-	10.414
	PEG1242 FourPeople Panel, Stand alone, W: 900, H: 1720, Straps	-		-	10.791
	PEG1342 FourPeople Panel, Stand alone, W: 1400, H: 1720, Straps	-		-	12.259

FourPeople Stand alone panels

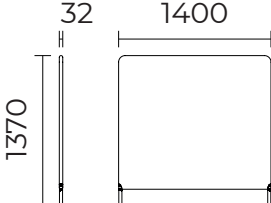
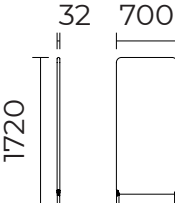
[Content ↗](#)

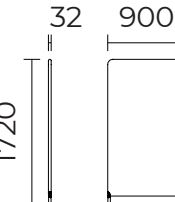

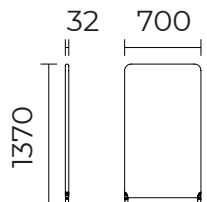



Design by Nørgaard Design

Product	Description (Item nr)	Weight (Kg)	Dimensions (mm)	Band	Standard (SEK)
	PEG1133 FourPeople Panel, Stand alone, W: 700, H: 1370, Fabric	-		1 2 3 4 5 6 7	9.772 10.099 10.427 11.168 11.507 11.750 12.624
	PEG1233 FourPeople Panel, Stand alone, W: 900, H: 1370, Fabric	-		1 2 3 4 5 6 7	10.124 10.524 10.948 11.883 12.309 12.624 13.716
	PEG1333 FourPeople Panel, Stand alone, W: 1400, H: 1370, Fabric	-		1 2 3 4 5 6 7	10.985 11.605 12.259 13.668 14.322 14.809 16.483
	PEG1143 FourPeople Panel, Stand alone, W: 700, H: 1720, Fabric	-		1 2 3 4 5 6 7	10.269 10.731 11.228 12.296 12.794 13.158 14.432
	PEG1243 FourPeople Panel, Stand alone, W: 900, H: 1720, Fabric	-		1 2 3 4 5 6 7	10.536 11.131 11.762 13.133 13.765 14.225 15.840
	PEG1343 FourPeople Panel, Stand alone, W: 1400, H: 1720, Fabric	-		1 2 3 4 5 6 7	11.750 12.659 13.631 15.731 16.702 17.418 19.894
	PEG1134 FourPeople Panel, Stand alone, W: 700, H: 1370, Fabric with acoustic	-		1 2 3 4 5 6 7	10.985 11.313 11.640 12.381 12.721 12.964 13.837
	PEG1234 FourPeople Panel, Stand alone, W: 900, H: 1370, Fabric with acoustic	-		1 2 3 4 5 6 7	11.459 11.859 12.284 13.218 13.644 13.959 15.051

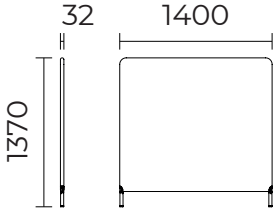
FourPeople Stand alone panels

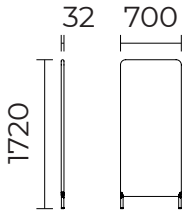
[Content ↗](#)

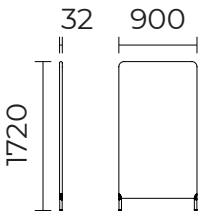
Design by Nørgaard Design

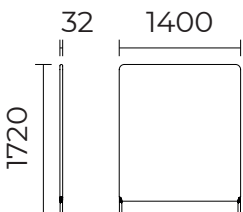
Product	Description (Item nr)	Weight (Kg)	Dimensions (mm)	Band	Standard (SEK)
	PEG1334 FourPeople Panel, Stand alone, W: 1400, H: 1370, Fabric with acoustic	-		1 2 3 4 5 6 7	13.340 13.959 14.614 16.022 16.677 17.164 18.837
	PEG1144 FourPeople Panel, Stand alone, W: 700, H: 1720, Fabric with acoustic	-		1 2 3 4 5 6 7	13.474 13.936 14.433 15.502 15.999 16.364 17.637
	PEG1244 FourPeople Panel, Stand alone, W: 900, H: 1720, Fabric with acoustic	-		1 2 3 4 5 6 7	12.866 13.461 14.092 15.464 16.095 16.555 18.170
	PEG1344 FourPeople Panel, Stand alone, W: 1400, H: 1720, Fabric with acoustic	-		1 2 3 4 5 6 7	16.277 17.187 18.158 20.258 21.229 21.946 24.421

ACCESSORIES	Description	Weight (Kg)	Dimensions (mm)	Band	Price (SEK)
	FOURPEOPLE HOOK ACC1001	0,1 kg			126

FourPeople Add on panels

Design by Nørgaard Design

[Content](#) ↗



FEATURES



- Panel Options: Open panel, Panel with straps, Fabric Panel, Fabric Panel with Acoustic Filling
- Can be combined with modules or modules with panels
- Offer acoustic and visual privacy
- Leg and frame in black (RAL7021)
- Diameter of foot 30 cm
- Upholstery available in various fabrics. For recommendations, please contact your sales representative











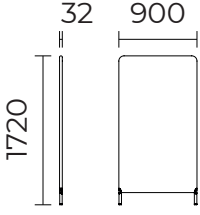

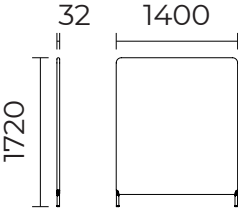
For product information visit oceefour.com ↗

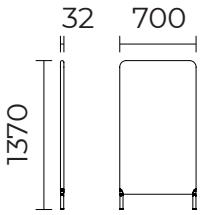
For full band and colour details [go to page 238](#) ↗

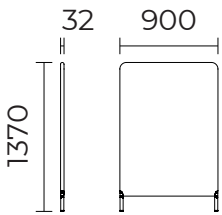
Product	Description (Item nr)	Weight (Kg)	Dimensions (mm)	Band	Standard (SEK)
	PEG2131 FourPeople Panel, Add on, W: 700, H: 1370, Frame	-	32 700 1370	-	8.121
	PEG2231 FourPeople Panel, Add on, W: 900, H: 1370, Frame	-	32 900 1370	-	8.327
	PEG2331 FourPeople Panel, Add on, W: 1400, H: 1370, Frame	-	32 1400 1370	-	8.837
	PEG2141 FourPeople Panel, Add on, W: 700, H: 1720, Frame	-	32 700 1720	-	8.364

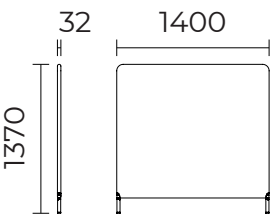
FourPeople Add on panels

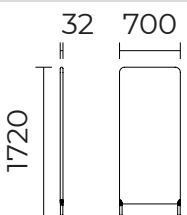
Design by Nørgaard Design

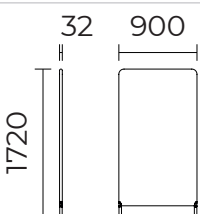
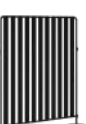
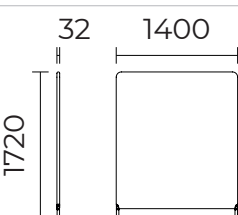
Product	Description (Item nr)	Weight (Kg)	Dimensions (mm)	Band	Standard (SEK)
	PEG2241 FourPeople Panel, Add on, W: 900, H: 1720, Frame	-		-	8.424
	PEG2341 FourPeople Panel, Add on, W: 1400, H: 1720, Frame	-		-	9.116
	PEG2132 FourPeople Panel, Add on, W: 700, H: 1370, Straps	-		-	9.068
	PEG2232 FourPeople Panel, Add on, W: 900, H: 1370, Straps	-		-	9.529
	PEG2332 FourPeople Panel, Add on, W: 1400, H: 1370, Straps	-		-	10.791
	PEG2142 FourPeople Panel, Add on, W: 700, H: 1720, Straps	-		-	9.298
	PEG2242 FourPeople Panel, Add on, W: 900, H: 1720, Straps	-		-	9.674
	PEG2342 FourPeople Panel, Add on, W: 1400, H: 1720, Straps	-		-	11.131

FourPeople Add on panels

[Content ↗](#)



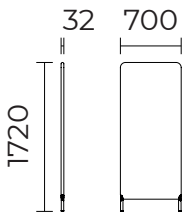



Design by Nørgaard Design

Product	Description (Item nr)	Weight (Kg)	Dimensions (mm)	Band	Standard (SEK)
	PEG2133 FourPeople Panel, Add on, W: 700, H: 1370, Fabric	-		1 2 3 4 5 6 7	8.654 8.969 9.309 10.039 10.379 10.633 11.495
	PEG2233 FourPeople Panel, Add on, W: 900, H: 1370, Fabric	-		1 2 3 4 5 6 7	9.007 9.407 9.832 10.754 11.191 11.507 12.599
	PEG2333 FourPeople Panel, Add on, W: 1400, H: 1370, Fabric	-		1 2 3 4 5 6 7	9.869 10.476 11.131 12.551 13.194 13.680 15.354
	PEG2143 FourPeople Panel, Add on, W: 700, H: 1720, Fabric	-		1 2 3 4 5 6 7	9.140 9.614 10.099 11.180 11.677 12.042 13.316
	PEG2243 FourPeople Panel, Add on, W: 900, H: 1720, Fabric	-		1 2 3 4 5 6 7	9.420 10.014 10.646 12.005 12.636 13.109 14.724
	PEG2343 FourPeople Panel, Add on, W: 1400, H: 1720, Fabric	-		1 2 3 4 5 6 7	10.633 11.543 12.514 14.614 15.573 16.290 18.777
	PEG2134 FourPeople Panel, Add on, W: 700, H: 1370, Fabric with acoustic	-		1 2 3 4 5 6 7	9.868 10.183 10.522 11.253 11.592 11.847 12.709
	PEG2234 FourPeople Panel, Add on, W: 900, H: 1370, Fabric with acoustic	-		1 2 3 4 5 6 7	10.343 10.743 11.168 12.090 12.527 12.843 13.935

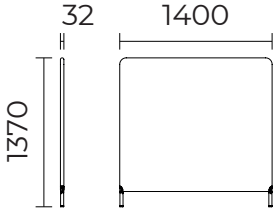
FourPeople Add on panels

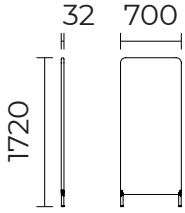
[Content ↗](#)

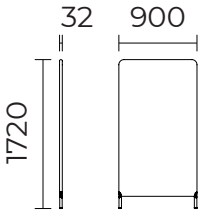
Design by Nørgaard Design

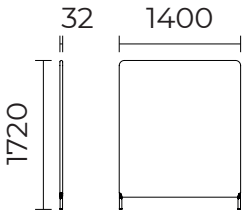
Product	Description (Item nr)	Weight (Kg)	Dimensions (mm)	Band	Standard (SEK)
	PEG2334 FourPeople Panel, Add on, W: 1400, H: 1370, Fabric with acoustic	-		1 2 3 4 5 6 7	12.224 12.831 13.485 14.906 15.548 16.035 17.709
	PEG2144 FourPeople Panel, Add on, W: 700, H: 1720, Fabric with acoustic	-		1 2 3 4 5 6 7	10.743 11.217 11.702 12.783 13.280 13.644 14.918
	PEG2244 FourPeople Panel, Add on, W: 900, H: 1720, Fabric with acoustic	-		1 2 3 4 5 6 7	11.750 12.344 12.976 14.335 14.966 15.439 17.054
	PEG2344 FourPeople Panel, Add on, W: 1400, H: 1720, Fabric with acoustic	-		1 2 3 4 5 6 7	15.161 16.070 17.042 19.142 20.100 20.817 23.305

ACCESSORIES	Description	Weight (Kg)	Dimensions (mm)	Band	Price (SEK)
	FOURPEOPLE HOOK ACC1001	0,1 kg			126

FourPeople Work Booth

Design by Nørgaard Design

[Content ↗](#)



FEATURES







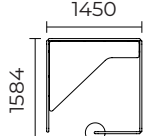

- Work Booth in various configurations.
- Closed concentrated work area with acoustic and visual privacy.
- Two heights 1370 cm or 1720 cm.
- Including table top in two heights: Standing 105 cm or sitting 74 cm.
- Black Nano laminate 21 mm table top with impact resistant ABS edges. Leg in black (RAL7021).
- Electrical units are optional and will be positioned in the centre of tables as standard.
- Upholstery available in various fabrics. For recommendations, please contact your sales representative

For product information visit oceefour.com ↗

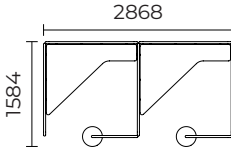
For electrical accessories [go to page 228](#) ↗

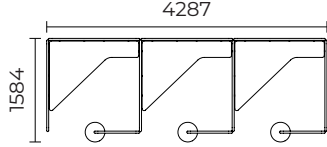
For full band and colour details [go to page 238](#) ↗

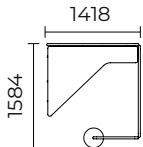
Product	Description (Item nr)	Weight (Kg)	Dimensions (mm)	Band	Price (SEK)
	PEJ13 FourPeople Single Work Booth, 1 Booth, H: 1370	119.1		<ul style="list-style-type: none"> 1 49.021 2 51.206 3 53.511 4 58.536 5 60.855 6 62.579 7 68.525 	
	PEJ23 FourPeople Single Work Booth, 2 Booth, H: 1370	205.4		<ul style="list-style-type: none"> 1 87.898 2 91.647 3 95.628 4 104.270 5 108.251 6 111.200 7 121.432 	
	PEJ33 FourPeople Single Work Booth, 3 Booth, H: 1370	291.7		<ul style="list-style-type: none"> 1 126.906 2 132.221 3 137.865 4 150.111 5 155.755 6 159.943 7 174.446 	
	PEJX3 FourPeople Single Work Booth, Extension, H: 1370	86.3		<ul style="list-style-type: none"> 1 39.761 2 41.328 3 42.991 4 46.607 5 48.270 6 49.507 7 53.780 	

FourPeople Work Booth

[Content ↗](#)







Design by Nørgaard Design

Product	Description (Item nr)	Weight (Kg)	Dimensions (mm)	Band	Price (SEK)
	PEK13 FourPeople Double Work Booth, 1 Booth, H: 1370	-		1 2 3 4 5 6 7	88.128 91.879 95.859 104.488 108.469 111.431 121.662
	PEK23 FourPeople Double Work Booth, 2 Booth, H: 1370	205.4		1 2 3 4 5 6 7	156.642 162.916 169.568 184.010 190.661 195.600 212.714
	PEK33 FourPeople Double Work Booth, 3 Booth, H: 1370	-		1 2 3 4 5 6 7	234.416 243.202 252.536 272.792 282.113 289.043 313.027
	PEKX3 FourPeople Double Work Booth, Extension, H: 1370	139.7		1 2 3 4 5 6 7	69.837 72.362 75.032 80.846 83.516 85.506 92.388
	PEJ14 FourPeople Single Work Booth, 1 Booth, H: 1720	-		1 2 3 4 5 6 7	51.692 52.142 54.459 59.484 61.803 63.513 69.473
	PEJ24 FourPeople Single Work Booth, 2 Booth, H: 1720	-		1 2 3 4 5 6 7	92.703 98.237 104.100 116.844 122.706 127.064 142.148
	PEJ34 FourPeople Single Work Booth, 3 Booth, H: 1720	-		1 2 3 4 5 6 7	133.727 141.568 149.881 167.940 176.254 182.432 203.817
	PEJX4 FourPeople Single Work Booth, Extension, H: 1720	-		1 2 3 4 5 6 7	41.777 44.095 46.535 51.862 54.314 56.135 62.433

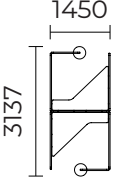
FourPeople Work Booth

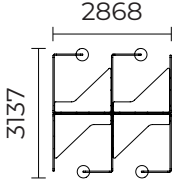
[Content ↗](#)

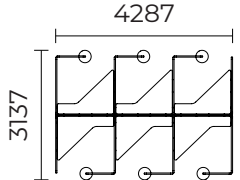
Design by Nørgaard Design

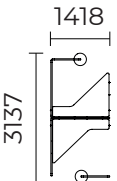
Product	Description (Item nr)	Weight (Kg)	Dimensions (mm)	Band	Price (SEK)
	PEK14 FourPeople Double Work Booth, 1 Booth, H: 1720	-		<ul style="list-style-type: none"> 1 92.935 2 98.469 3 104.331 4 117.062 5 122.936 6 127.294 7 142.380 	
	PEK24 FourPeople Double Work Booth, 2 Booth, H: 1720	-		<ul style="list-style-type: none"> 1 164.713 2 173.961 3 183.755 4 205.031 5 214.837 6 222.107 7 247.317 	
	PEK34 FourPeople Double Work Booth, 3 Booth, H: 1720	-		<ul style="list-style-type: none"> 1 236.831 2 249.780 3 263.520 4 293.340 5 307.066 6 317.274 7 352.580 	
	PEKX4 FourPeople Double Work Booth, Extension, H: 1720	-		<ul style="list-style-type: none"> 1 73.114 2 76.816 3 80.748 4 89.294 5 93.225 6 96.150 7 106.261 	

ACCESSORIES	Description	Weight (Kg)	Dimensions (mm)	Band	Price (SEK)
	FOURPEOPLE HOOK ACC1001	0,1 kg			126

FourPeople Study Booth

Design by Nørgaard Design

[Content ↗](#)



FEATURES







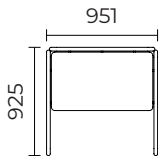

- Study Booth in various configurations.
- Private touch down area with acoustic and visual privacy.
- Two heights 1370 or 1720 cm.
- Including table top in two heights: Standing 105 cm or sitting 74 cm.
- Black Nano laminate 21 mm table top with impact resistant ABS edges. Leg in standard black (RAL7021).
- Electrical units are optional and will be positioned in the centre of tables as standard.
- Upholstery available in various fabrics. For recommendations, please contact your sales representative.

For product information visit oceefour.com ↗

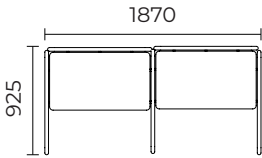
For electrical accessories [go to page 228](#) ↗

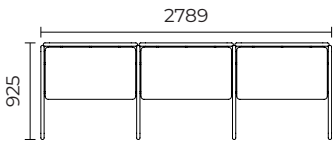
For full band and colour details [go to page 238](#) ↗

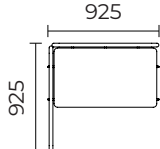
Product	Description (Item nr)	Weight (Kg)	Dimensions (mm)	Band	Price (SEK)													
	PEH13 FourPeople Single Study Booth, 1 Booth, H: 1370	71.6		<table border="1"> <tr><td>1</td><td>30.270</td></tr> <tr><td>2</td><td>31.546</td></tr> <tr><td>3</td><td>32.892</td></tr> <tr><td>4</td><td>35.817</td></tr> <tr><td>5</td><td>37.165</td></tr> <tr><td>6</td><td>38.172</td></tr> <tr><td>7</td><td>41.631</td></tr> </table>	1	30.270	2	31.546	3	32.892	4	35.817	5	37.165	6	38.172	7	41.631
1	30.270																	
2	31.546																	
3	32.892																	
4	35.817																	
5	37.165																	
6	38.172																	
7	41.631																	
	PEH23 FourPeople Single Study Booth, 2 Booth, H: 1370	123.8		<table border="1"> <tr><td>1</td><td>47.227</td></tr> <tr><td>2</td><td>53.198</td></tr> <tr><td>3</td><td>55.443</td></tr> <tr><td>4</td><td>60.322</td></tr> <tr><td>5</td><td>62.580</td></tr> <tr><td>6</td><td>64.242</td></tr> <tr><td>7</td><td>70.020</td></tr> </table>	1	47.227	2	53.198	3	55.443	4	60.322	5	62.580	6	64.242	7	70.020
1	47.227																	
2	53.198																	
3	55.443																	
4	60.322																	
5	62.580																	
6	64.242																	
7	70.020																	
	PEH33 FourPeople Single Study Booth, 3 Booth, H: 1370	174.5		<table border="1"> <tr><td>1</td><td>70.906</td></tr> <tr><td>2</td><td>73.866</td></tr> <tr><td>3</td><td>77.022</td></tr> <tr><td>4</td><td>83.855</td></tr> <tr><td>5</td><td>86.999</td></tr> <tr><td>6</td><td>89.329</td></tr> <tr><td>7</td><td>97.425</td></tr> </table>	1	70.906	2	73.866	3	77.022	4	83.855	5	86.999	6	89.329	7	97.425
1	70.906																	
2	73.866																	
3	77.022																	
4	83.855																	
5	86.999																	
6	89.329																	
7	97.425																	
	PEHX3 FourPeople Single Study Booth, Extension, H: 1370	50.7		<table border="1"> <tr><td>1</td><td>21.581</td></tr> <tr><td>2</td><td>22.431</td></tr> <tr><td>3</td><td>23.328</td></tr> <tr><td>4</td><td>25.270</td></tr> <tr><td>5</td><td>26.181</td></tr> <tr><td>6</td><td>26.848</td></tr> <tr><td>7</td><td>29.154</td></tr> </table>	1	21.581	2	22.431	3	23.328	4	25.270	5	26.181	6	26.848	7	29.154
1	21.581																	
2	22.431																	
3	23.328																	
4	25.270																	
5	26.181																	
6	26.848																	
7	29.154																	

FourPeople Study Booth

[Content ↗](#)







Design by Nørgaard Design

Product	Description (Item nr)	Weight (Kg)	Dimensions (mm)	Band	Price (SEK)
	PEI13 FourPeople Double Study Booth, 1 Booth, H: 1370	121.9		1 2 3 4 5 6 7	49.969 52.094 54.339 59.217 61.464 63.137 68.916
	PEI23 FourPeople Double Study Booth, 2 Booth, H: 1370	202.8		1 2 3 4 5 6 7	81.792 83.917 86.162 91.040 93.285 94.961 100.737
	PEI33 FourPeople Double Study Booth, 3 Booth, H: 1370	-		1 2 3 4 5 6 7	117.839 122.499 127.451 138.181 143.132 146.798 159.517
	PEIX3 FourPeople Double Study Booth, Extension, H: 1370	79		1 2 3 4 5 6 7	34.591 35.866 37.213 40.139 41.485 42.492 45.964
	PEH14 FourPeople Single Study Booth, 1 Booth, H: 1720	-		1 2 3 4 5 6 7	31.618 33.536 35.550 39.944 41.970 43.476 48.670
	PEH24 FourPeople Single Study Booth, 2 Booth, H: 1720	-		1 2 3 4 5 6 7	54.751 58.780 63.053 72.325 76.598 79.765 90.750
	PEH34 FourPeople Single Study Booth, 3 Booth, H: 1720	-		1 2 3 4 5 6 7	76.136 81.647 87.484 100.180 106.018 110.362 125.388
	PEHX4 FourPeople Single Study Booth, Extension, H: 1720	-		1 2 3 4 5 6 7	23.899 26.010 28.257 33.147 35.392 37.055 42.844

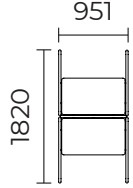
FourPeople Study Booth

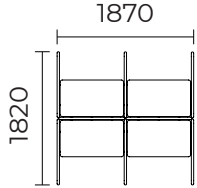
[Content ↗](#)

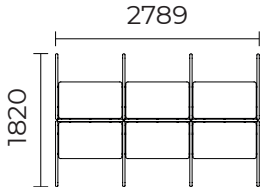
Design by Nørgaard Design

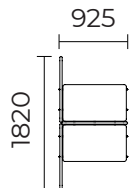
Product	Description (Item nr)	Weight (Kg)	Dimensions (mm)	Band	Price (SEK)
	PEI14 FourPeople Double Study Booth, 1 Booth, H: 1720	-		<ul style="list-style-type: none"> 1 2 3 4 5 6 7 	<ul style="list-style-type: none"> 52.227 55.406 58.780 66.099 69.473 71.973 80.651
	PEI24 FourPeople Double Study Booth, 2 Booth, H: 1720	-		<ul style="list-style-type: none"> 1 2 3 4 5 6 7 	<ul style="list-style-type: none"> 86.744 91.829 97.218 108.931 114.332 118.336 132.209
	PEI34 FourPeople Double Study Booth, 3 Booth, H: 1720	-		<ul style="list-style-type: none"> 1 2 3 4 5 6 7 	<ul style="list-style-type: none"> 121.722 128.727 136.142 152.247 159.664 165.173 184.240
	PEIX4 FourPeople Double Study Booth, Extension, H: 1720	-		<ul style="list-style-type: none"> 1 2 3 4 5 6 7 	<ul style="list-style-type: none"> 35.951 37.857 39.883 44.277 46.292 47.796 53.003

ACCESSORIES	Description	Weight (Kg)	Dimensions (mm)	Band	Price (SEK)
	FOURPEOPLE HOOK ACC1001	0,1 kg			126

FourPeople Work Hut

Design by Nørgaard Design

[Content ↗](#)



FEATURES



- Private touch down area with acoustic and visual privacy.
- Including table top in two heights: Standing 105 cm or sitting 74 cm, right or left side.
- Black Nano laminate 21 mm table top with impact resistant ABS edges. Leg in black (RAL7021).
- Electrical units are optional and will be positioned in the centre of tables as standard.
- Upholstery available in various fabrics. For recommendations, please contact your sales representative.

For product information visit oceefour.com ↗

For electrical accessories [go to page 228](#) ↗

For full band and colour details [go to page 238](#) ↗

Product	Description (Item nr)	Weight (Kg)	Dimensions (mm)	Band	Price (SEK)														
	PEM3L FourPeople Work Hut, Fabric, Left	-		<table border="1"> <tr><td>1</td><td>42.432</td></tr> <tr><td>2</td><td>45.891</td></tr> <tr><td>3</td><td>49.555</td></tr> <tr><td>4</td><td>57.506</td></tr> <tr><td>5</td><td>61.170</td></tr> <tr><td>6</td><td>63.890</td></tr> <tr><td>7</td><td>73.307</td></tr> </table>	1	42.432	2	45.891	3	49.555	4	57.506	5	61.170	6	63.890	7	73.307	
1	42.432																		
2	45.891																		
3	49.555																		
4	57.506																		
5	61.170																		
6	63.890																		
7	73.307																		
	PEM3R FourPeople Work Hut, Fabric, Right	-		<table border="1"> <tr><td>1</td><td>42.432</td></tr> <tr><td>2</td><td>45.891</td></tr> <tr><td>3</td><td>49.555</td></tr> <tr><td>4</td><td>57.506</td></tr> <tr><td>5</td><td>61.170</td></tr> <tr><td>6</td><td>63.890</td></tr> <tr><td>7</td><td>73.307</td></tr> </table>	1	42.432	2	45.891	3	49.555	4	57.506	5	61.170	6	63.890	7	73.307	
1	42.432																		
2	45.891																		
3	49.555																		
4	57.506																		
5	61.170																		
6	63.890																		
7	73.307																		

ACCESSORIES	Description	Weight (Kg)	Dimensions (mm)	Band	Price (SEK)
	FOURPEOPLE HOOK ACCT001	0,1 kg			126

FourPeople Sofa Hut

Design by Nørgaard Design

[Content](#) ↗



FEATURES



- Provide a relaxed and sociable space with acoustic and visual privacy.
- Comes in low or high back with straps or fabric.
- Two tone fabric options available.
- Electrical units are optional and will be positioned on the left or right side of sofas as standard.
- Leg in black (RAL7021).
- Upholstery available in various fabrics. For recommendations, please contact your sales representative.

For product information visit oceefour.com ↗

For electrical accessories [go to page 228](#) ↗

For full band and colour details [go to page 238](#) ↗

Product	Description (Item nr)	Weight (Kg)	Dimensions (mm)	Band	Price (SEK)
	PEL2H FourPeople Sofa Hut, Straps, High back	70		<ul style="list-style-type: none"> 1 49.969 2 50.879 3 51.850 4 53.950 5 54.921 6 55.636 7 58.125 	
	PEL2L FourPeople Sofa Hut, Straps, Low back	41.6		<ul style="list-style-type: none"> 1 47.190 2 47.869 3 48.585 4 50.151 5 50.866 6 51.400 7 53.246 	
	PEL3H FourPeople Sofa Hut, Fabric, High back	-		<ul style="list-style-type: none"> 1 48.257 2 52.420 3 56.827 4 66.390 5 70.795 6 74.061 7 85.396 	
	PEL3L FourPeople Sofa Hut, Fabric, Low back	-		<ul style="list-style-type: none"> 1 45.477 2 49.398 3 53.548 4 62.579 5 66.742 6 69.825 7 80.517 	





FourLikes®



FourLikes® Meet



FourLikes® Scooter |
Wheels



FourLikes® Scooter



FourLikes® Wall bench









FEATURES



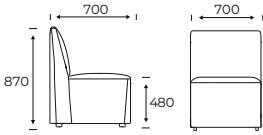

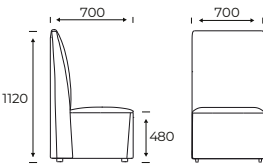

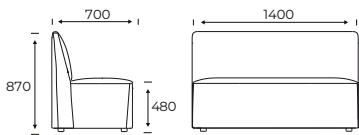

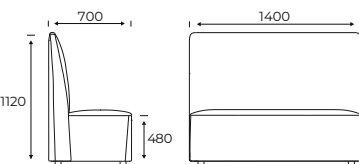

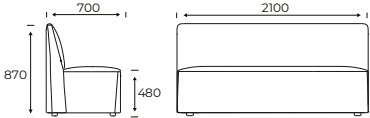

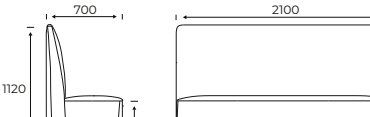

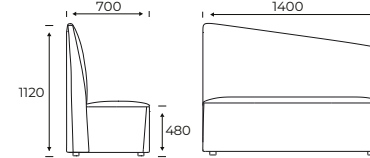
- Modular and flexible system. Modules in different lengths.
- Low and high back modules. Uni- or Multicoloured.
- Active seat height 48 cm (fits table height 74 cm).
- Frame delivered as standard in black.
- Electrical units are optional and will be positioned on the left or right side of sofas as standard.

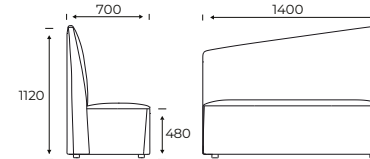

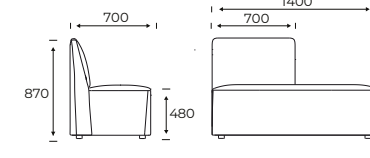

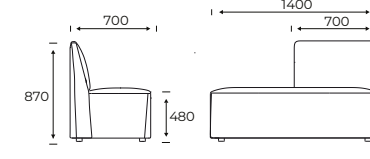

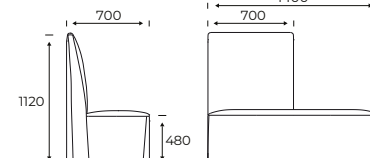

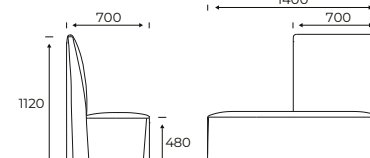
For product information visit oceefour.com ↗

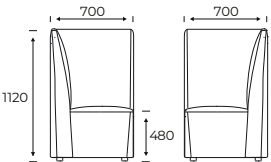

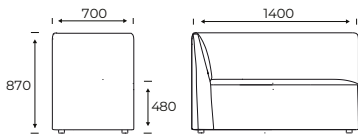

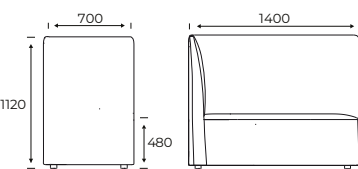
For electrical accessories [go to page 228](#) ↗

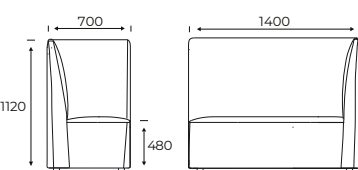
For full band and colour details [go to page 238](#) ↗

Product	Description (Item nr)	Weight (Kg)	Dimensions (mm)	Band	Same colour (SEK)	Different seat colour (SEK)
	700000 FourLikes®, Low back, 700	20,5 Kg		1 2 3 4 5	9.859 11.146 12.437 13.724 15.014	2.152 2.656 3.379 3.964 4.610 6.770
	700010 FourLikes®, High back, 700	21,5 Kg		1 2 3 4 5	11.079 12.653 14.228 15.804 17.381	2.152 2.656 3.379 3.964 4.610 6.770
	700001 FourLikes®, Low back, 1400	41,3 Kg		1 2 3 4 5	13.144 14.864 16.581 18.298 20.018	2.982 3.681 4.685 5.494 6.393 9.388
	700011 FourLikes®, High back, 1400	42,5 Kg		1 2 3 4 5	14.772 16.873 18.973 21.072 23.173	2.982 3.681 4.685 5.494 6.393 9.388

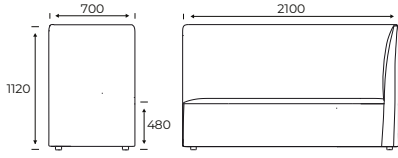
Product	Description (Item nr)	Weight (Kg)	Dimensions (mm)	Band	Same colour (SEK)	Different seat colour (SEK)
	700002 FourLikes®, Low back, 2100	-		1 2 3 4 5	21.031 23.781 26.531 29.282 32.031	4.589 5.665 7.210 8.452 9.840 14.445
	700012 FourLikes®, High back, 2100	-		1 2 3 4 5	23.635 26.994 30.355 33.716 37.077	4.589 5.665 7.210 8.452 9.840 14.445
	700021 FourLikes®, Slope, High Back Right, 1400	-		1 2 3 4 5	15.777 17.878 19.978 22.077 24.179	2.982 3.681 4.685 5.494 6.393 9.388
	700031 FourLikes®, Slope, High Back Left, 1400	-		1 2 3 4 5	15.777 17.878 19.978 22.077 24.179	2.982 3.681 4.685 5.494 6.393 9.388
	700041 FourLikes®, Open End Left, Low Back Right, 1400	45,5 Kg		1 2 3 4 5	14.808 16.069 17.328 18.588 19.850	2.982 3.681 4.685 5.494 6.393 9.388
	700051 FourLikes®, Open End Right, Low Back Left, 1400	45,6 Kg		1 2 3 4 5	14.808 16.069 17.328 18.588 19.850	2.982 3.681 4.685 5.494 6.393 9.388
	700061 FourLikes®, Open End Left, High Back Right, 1400	46,8 Kg		1 2 3 4 5	16.844 18.592 20.337 22.084 23.831	2.982 3.681 4.685 5.494 6.393 9.388
	700071 FourLikes®, Open End Right, High Back Left, 1400	46,8 Kg		1 2 3 4 5	16.844 18.592 20.337 22.084 23.831	2.982 3.681 4.685 5.494 6.393 9.388

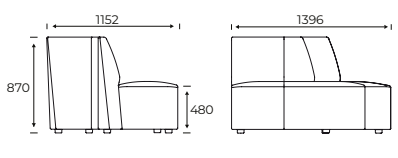
Product	Description (Item nr)	Weight (Kg)	Dimensions (mm)	Band	Same colour (SEK)	Different seat colour (SEK)
	700100 FourLikes®, Corner, Low back, 700	20,8 Kg		1 2 3 4 5	12.979 14.343 15.706 17.072 18.436	2.152 2.656 3.379 3.964 4.610 6.770
	700110 FourLikes®, Corner, High back, 700	27,3 Kg		1 2 3 4 5	14.868 17.073 19.281 21.487 23.694	2.152 2.656 3.379 3.964 4.610 6.770
	700191 FourLikes®, Corner, Low Back Right, 1400	45,3 Kg		1 2 3 4 5	15.269 16.873 18.477 20.082 21.685	2.982 3.681 4.685 5.494 6.393 9.388
	700181 FourLikes®, Corner, Low Back Left, 1400	45,3 Kg		1 2 3 4 5	15.269 16.873 18.477 20.082 21.685	2.982 3.681 4.685 5.494 6.393 9.388
	7001B1 FourLikes®, Corner, High Back Right, 1400	50,4 Kg		1 2 3 4 5	18.191 20.893 23.592 26.292 28.995	2.982 3.681 4.685 5.494 6.393 9.388
	7001A1 FourLikes®, Corner, High Back Left, 1400	50,4 Kg		1 2 3 4 5	18.191 20.893 23.592 26.292 28.995	2.982 3.681 4.685 5.494 6.393 9.388
	700192 FourLikes®, Corner, Low Back Right, 2100	66,9 Kg		1 2 3 4 5	24.430 26.999 29.564 32.130 34.697	4.589 5.665 7.210 8.452 9.840 14.445
	700182 FourLikes®, Corner, Low Back Left, 2100	66,9 Kg		1 2 3 4 5	24.430 26.999 29.564 32.130 34.697	4.589 5.665 7.210 8.452 9.840 14.445

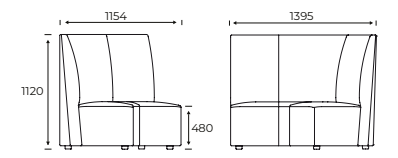
Product	Description (Item nr)	Weight (Kg)	Dimensions (mm)	Band	Same colour (SEK)	Different seat colour (SEK)
	7001B2 FourLikes®, Corner, High Back Right, 2100	77,8 Kg		1 2 3 4 5	27.986 32.142 36.297 40.452 44.606	4.589 5.665 7.210 8.452 9.840 14.445
	7001A2 FourLikes®, Corner, High Back Left, 2100	77,8 Kg		1 2 3 4 5	27.986 32.142 36.297 40.452 44.606	4.589 5.665 7.210 8.452 9.840 14.445
	7000E7 FourLikes®, Convex 120 Low back, 1350			1 2 3 4 5	21.632 22.898 25.605 26.864 29.387	4.721 5.453 6.956 7.756 9.031 13.242
	7000F7 FourLikes®, Convex 120 High back, 1350	35 kg		1 2 3 4 5	23.078 24.402 27.404 28.846 31.669	4.721 5.453 6.956 7.756 9.031 13.242
	7000C1 FourLikes®, Concave 120 Low back, 1400	35,5 Kg		1 2 3 4 5	23.017 24.402 27.342 28.662 31.372	5.023 5.810 7.427 8.275 9.642 14.136
	7000D1 FourLikes®, Concave 120 High back, 1400	38,5 Kg		1 2 3 4 5	25.840 27.342 30.592 32.095 35.098	5.023 5.810 7.427 8.275 9.642 14.136



FEATURES

- Modular and flexible system. Uni- or Multicoloured.
- Acoustic and visual privacy.
- Active seat height 48 cm (fits table height 74 cm).
- Table top: 70x70cm or 120x70 cm
- Table top in black, warm grey or anthracite Nano laminate
- Electrical units are optional and will be positioned in the centre of tables as standard.

For product information visit oceefour.com ↗

TABLE TOP

Fenix laminate



FRAME COLOURS

Standard



For electrical accessories [go to page 228](#) ↗



For full band and colour details [go to page 238](#) ↗

Product	Description (Item nr)	Weight (Kg)	Dimensions (mm)	Band	Same colour (SEK)	Different colour (SEK)
	70120 FourLikes® Meet, 700	152 Kg		1 2 3 4 5	44.124 49.738 55.351 60.965 66.580	
	70120-S FourLikes® Meet, 700			1 2 3 4 5 8		4.474 5.753 7.032 8.313 9.592 13.429
	70120-T FourLikes® Meet, 700			1 2 3 4 5 8		6.304 7.098 7.889 8.681 9.472 11.850
	70121 FourLikes® Meet, 1400	183 Kg		1 2 3 4 5	58.829 66.314 73.798 81.283 88.768	

FourLikes® Meet

Design by Nørgaard Design

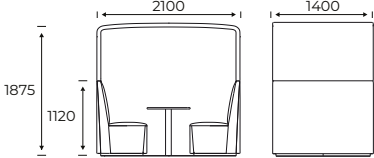
[Content ↗](#)

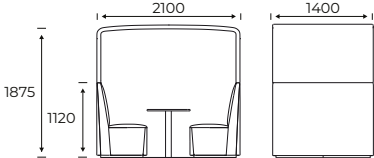
Product	Description (Item nr)	Weight (Kg)	Dimensions (mm)	Band	Same colour (SEK)	Different colour (SEK)
	70121-S FourLikes® Meet, 1400			1 2 3 4 5 8		5.966 7.366 9.376 10.988 12.791 18.777
	70121-T FourLikes® Meet, 1400			1 2 3 4 5 8		8.404 9.475 10.544 11.612 12.682 18.027

ACCESSORIES	Description	Weight (Kg)	Dimensions (mm)	Price (SEK)
	With Linking			263

FourLikes® Scooter | Wheels

Design by Nørgaard Design

[Content ↗](#)







FEATURES

- Scooter including wheels
- Single back or double back options
- Active seat height 48 cm (Fits table height 74 cm)

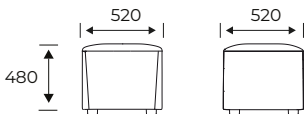

For product information visit oceefour.com ↗

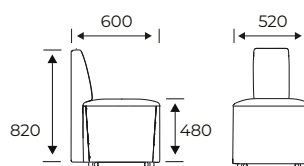
For full band and colour details [go to page 238](#) ↗

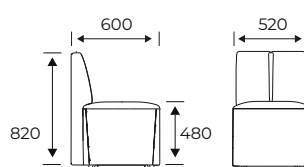
Product	Description (Item nr)	Weight (Kg)	Dimensions (mm)	Band	Same colour (SEK)												
	7024030-W FourLikes® Scooter, Straight, 530, Without backs, Castors	9,5 Kg		<table border="1"> <tr><td>1</td><td>6.102</td></tr> <tr><td>2</td><td>6.618</td></tr> <tr><td>3</td><td>7.137</td></tr> <tr><td>4</td><td>7.652</td></tr> <tr><td>5</td><td>8.167</td></tr> <tr><td>8</td><td>10.752</td></tr> </table>	1	6.102	2	6.618	3	7.137	4	7.652	5	8.167	8	10.752	
1	6.102																
2	6.618																
3	7.137																
4	7.652																
5	8.167																
8	10.752																
	702403A-W FourLikes® Scooter, Straight, 530, 1 single back, Castors	11,6 Kg		<table border="1"> <tr><td>1</td><td>8.040</td></tr> <tr><td>2</td><td>8.721</td></tr> <tr><td>3</td><td>9.405</td></tr> <tr><td>4</td><td>10.084</td></tr> <tr><td>5</td><td>10.764</td></tr> <tr><td>8</td><td>14.172</td></tr> </table>	1	8.040	2	8.721	3	9.405	4	10.084	5	10.764	8	14.172	
1	8.040																
2	8.721																
3	9.405																
4	10.084																
5	10.764																
8	14.172																
	7024031-W FourLikes® Scooter, Straight, 530, 1 double back, Castors	13,4 Kg		<table border="1"> <tr><td>1</td><td>9.328</td></tr> <tr><td>2</td><td>10.035</td></tr> <tr><td>3</td><td>10.744</td></tr> <tr><td>4</td><td>11.449</td></tr> <tr><td>5</td><td>12.157</td></tr> <tr><td>8</td><td>15.696</td></tr> </table>	1	9.328	2	10.035	3	10.744	4	11.449	5	12.157	8	15.696	
1	9.328																
2	10.035																
3	10.744																
4	11.449																
5	12.157																
8	15.696																







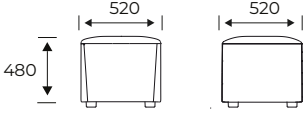

FEATURES

- FourLikes Scooter including legs.
- Single back or double back options.
- Active seat height 48 cm (fits table height 74 cm).
- Only FourLikes Scooter 1400/2100: Electrical units are optional and will be positioned on the left or right side of sofas as standard.

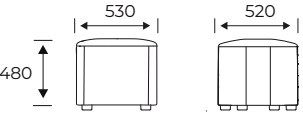
For product information visit oceefour.com ↗

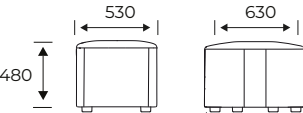

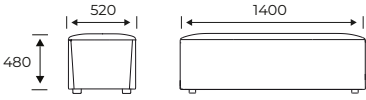
For full band and colour details [go to page 238](#) ↗

Product	Description (Item nr)	Weight (Kg)	Dimensions (mm)	Band	Same colour (SEK)
	7024030 FourLikes® Scooter, Straight, 530, Without backs	9,5 Kg		1 2 3 4 5 8	5.326 5.842 6.361 6.876 7.391 9.976
	7024130 FourLikes® Scooter, 45 degree, 530, Without backs	9,7 Kg		1 2 3 4 5 8	5.889 6.462 7.033 7.606 8.180 11.040
	7024230 FourLikes® Scooter, 90 degree, 530, Without backs	10,4 Kg		1 2 3 4 5 8	6.773 7.431 8.088 8.745 9.400 12.686
	7024010 FourLikes® Scooter, Straight, 1400, Without backs	26,4 Kg		1 2 3 4 5 8	9.554 11.044 12.531 14.024 15.511 22.959

FourLikes® Scooter

Design by Nørsgaard Design

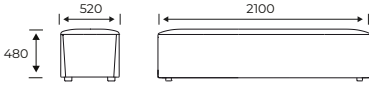
[Content ↗](#)

Product	Description (Item nr)	Weight (Kg)	Dimensions (mm)	Band	Same colour (SEK)
	7024020 FourLikes® Scooter, Straight, 2100, Without backs	40,5 Kg		1 2 3 4 5 8	10.560 12.049 13.536 15.029 16.517 23.962
	7024XXA FourLikes® Scooter, Straight, 1400, 1 single back	2,1 Kg		1 2 3 4 5 8	1.938 2.103 2.268 2.432 2.597 3.420
	7024XX1 FourLikes® Scooter, Straight, 1400, 1 double back	3,9 Kg		1 2 3 4 5 8	3.226 3.417 3.607 3.797 3.990 4.944

ACCESSORIES	Description	Weight (Kg)	Dimensions (mm)	Price (SEK)
	With Linking			416

FourLikes® Wall bench

Design by Nørgaard Design

[Content ↗](#)









FEATURES

- Wall-mounted (We recommend a sitting height of 46-48 cm.)
- Compact footprint for utilisation of all square metres
- We recommend at least two brackets per 140 cm
- We recommend a max. load of 150 kg. per 2 brackets as well as mounting on concrete/brick wall
- Backrest is supplied with a vertical wall mount bracket
- The seat is delivered without screws and brackets

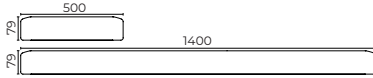

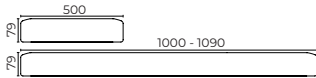
For product information visit oceefour.com ↗



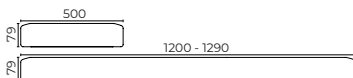





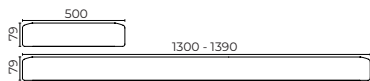

For full band and colour details [go to page 238](#) ↗

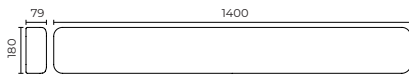
Product	Description (Item nr)	Weight (Kg)	Dimensions (mm)	Band	Same colour (SEK)												
	70331I FourLikes® Wall Bench, Seat, 1400	9,2 Kg		<table border="1"> <tr><td>1</td><td>4.577</td></tr> <tr><td>2</td><td>5.460</td></tr> <tr><td>3</td><td>6.344</td></tr> <tr><td>4</td><td>7.228</td></tr> <tr><td>5</td><td>8.112</td></tr> <tr><td>8</td><td>12.526</td></tr> </table>	1	4.577	2	5.460	3	6.344	4	7.228	5	8.112	8	12.526	
1	4.577																
2	5.460																
3	6.344																
4	7.228																
5	8.112																
8	12.526																
	70331A FourLikes® Wall Bench, Seat, 1000-1090	(6,5 Kg)		<table border="1"> <tr><td>1</td><td>5.099</td></tr> <tr><td>2</td><td>5.923</td></tr> <tr><td>3</td><td>6.750</td></tr> <tr><td>4</td><td>7.575</td></tr> <tr><td>5</td><td>8.398</td></tr> <tr><td>8</td><td>12.524</td></tr> </table>	1	5.099	2	5.923	3	6.750	4	7.575	5	8.398	8	12.524	
1	5.099																
2	5.923																
3	6.750																
4	7.575																
5	8.398																
8	12.524																
	70331B FourLikes® Wall Bench, Seat, 1100-1190	(7,2 Kg)		<table border="1"> <tr><td>1</td><td>5.282</td></tr> <tr><td>2</td><td>6.152</td></tr> <tr><td>3</td><td>7.021</td></tr> <tr><td>4</td><td>7.891</td></tr> <tr><td>5</td><td>8.760</td></tr> <tr><td>8</td><td>13.107</td></tr> </table>	1	5.282	2	6.152	3	7.021	4	7.891	5	8.760	8	13.107	
1	5.282																
2	6.152																
3	7.021																
4	7.891																
5	8.760																
8	13.107																
	70331C FourLikes® Wall Bench, Seat, 1200-1290	(7,9 Kg)		<table border="1"> <tr><td>1</td><td>5.466</td></tr> <tr><td>2</td><td>6.389</td></tr> <tr><td>3</td><td>7.311</td></tr> <tr><td>4</td><td>8.233</td></tr> <tr><td>5</td><td>9.154</td></tr> <tr><td>8</td><td>13.763</td></tr> </table>	1	5.466	2	6.389	3	7.311	4	8.233	5	9.154	8	13.763	
1	5.466																
2	6.389																
3	7.311																
4	8.233																
5	9.154																
8	13.763																

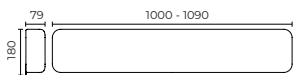
FourLikes® Wall bench

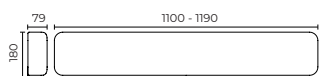
Design by Nørsgaard Design

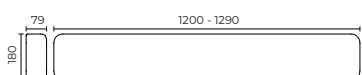
[Content ↗](#)

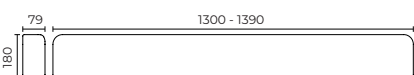
Product	Description (Item nr)	Weight (Kg)	Dimensions (mm)	Band	Same colour (SEK)
	70331D FourLikes® Wall Bench, Seat, 1300-1390	(8,5 Kg)		1 2 3 4 5 8	5.588 6.562 7.533 8.504 9.476 14.338
	703321 FourLikes® Wall Bench, Backrest, 1400	2,6 Kg		1 2 3 4 5 8	5.382 6.204 7.026 7.846 8.667 12.775
	70332A FourLikes® Wall Bench, Backrest, 1000-1090	(1,8 Kg)		1 2 3 4 5 8	4.951 5.594 6.235 6.876 7.519 10.727
	70332B FourLikes® Wall Bench, Backrest, 1100-1190	(2 Kg)		1 2 3 4 5 8	5.094 5.775 6.459 7.142 7.823 11.235
	70332C FourLikes® Wall Bench, Backrest, 1200-1290	(2,2 Kg)		1 2 3 4 5 8	5.168 5.900 6.633 7.366 8.098 11.760
	70332D FourLikes® Wall Bench, Backrest, 1300-1390	(2,4 Kg)		1 2 3 4 5 8	5.310 6.084 6.860 7.636 8.410 12.285

ACCESSORIES	Description	Weight (Kg)	Dimensions (mm)	Price (SEK)
	With Bracket			1.507







FourUs®



FourUs® Booth



FourUs® Booth 2



FourUs® Work Booth



FourUs® Solo



FourUs® 3-Seater



FourUs® Wallpod



FourUs® Worx









FEATURES



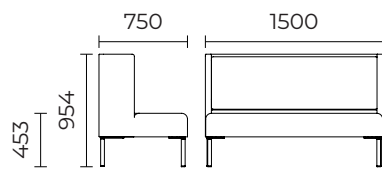

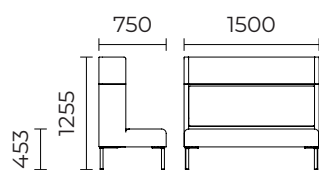

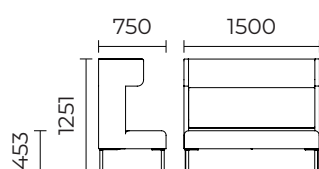

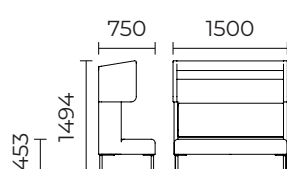
- Acoustic and visual privacy
- Linking options
- Uni- or Multicolored
- Facility friendly; designed for optimal cleaning
- Optional: Castors, Skid frame, InnoTab tablet, Magazine holder, Shelf (height 95 cm).
- Electrical units are optional and will be positioned on the left or right side of sofas as standard.

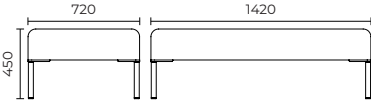
For product information visit oceefour.com ↗

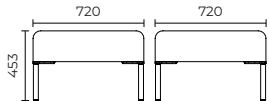
For electrical accessories [go to page 228](#) ↗

For full band and colour details [go to page 238](#) ↗

Product	Description (Item nr)	Weight (Kg)	Dimensions (mm)	Band	Same colour (SEK)	Different colour (SEK)
	80000 FourUs®, Bench	52 kg		1 2 3 4 5 8	19.880 21.785 23.319 24.773 28.463 52.361	
	80001 FourUs®, Extension	64 kg		1 2 3 4 5 8	24.812 26.944 28.659 30.263 34.884 64.583	
	80002 FourUs®, Ear	58 kg		1 2 3 4 5 8	26.176 28.020 29.648 31.472 36.690 66.569	
	80003 FourUs®, Cave	70 kg		1 2 3 4 5 8	30.253 32.423 34.440 36.461 43.179 81.938	

Product	Description (Item nr)	Weight (Kg)	Dimensions (mm)	Band	Same colour (SEK)	Different colour (SEK)
	80004 FourUs®, Daybed	25 kg		1 2 3 4 5 8	10.081 10.767 11.310 11.897 13.693 21.514	
	80005 FourUs®, Stool	16 kg		1 2 3 4 5 8	8.064 8.778 9.184 9.789 10.484 13.894	
	80000-S FourUs®, Bench, Seat			1 2 3 4 5 8		2.574 3.176 4.044 4.739 5.517 8.097
	80000-C FourUs®, Bench, Cushion			1 2 3 4 5 8		2.574 2.996 3.052 3.297 3.534 5.753
	80001-T FourUs®, Extension, Top			1 2 3 4 5 8		1.807 1.986 2.505 3.033 3.554 4.963
	80002-T FourUs®, Ear, Top			1 2 3 4 5 8		2.210 2.791 3.522 4.091 4.802 6.835
	80003-T FourUs®, Cave, Top			1 2 3 4 5 8		4.058 5.215 6.344 7.313 8.448 10.504

ACCESSORIES	Description	Weight (Kg)	Dimensions (mm)	Price (SEK)
	FOURUS LEGS Castors			3,960
	FOURUS LEGS Skid frame			3,742
	160800L InnoTab, FourUs, Left			3,872
	160800R InnoTab, FourUs, Right			3,872
	899010 FourUs® Optional Extras, Magazine holder black, 30 cm	4,9 Kg	300 x 352 mm	1,089
	899020 FourUs® Optional Extras, Magazine holder black, 70 cm	5,6 Kg	700 x 325 mm	1,484
	899100 FourUs® Optional Extras, Shelf black	5,8 Kg	L1412 mm	5,949

FourUs® Booth

Design by Nørgaard Design

[Content ↗](#)



FEATURES





- Private working area for 4 people. Acoustic and visual privacy.
- Uni- or multicoloured.
- Facility friendly; designed for optimal cleaning.
- Optional: Pivot table that effortlessly moves both horizontally and vertically (Nano laminate: Warm grey, Anthracite or Black).
- Frame and fittings in black, matt lacquered.
- Optional: Skid frame, Magazine holder, Shelf (height 95 cm) TV bracket.
- Electrical units are optional in sofa and in tabletop.





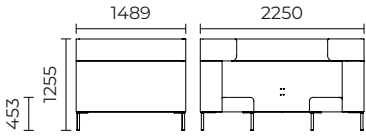



For product information visit oceefour.com ↗

For electrical accessories [go to page 228](#) ↗

For full band and colour details [go to page 238](#) ↗

Product	Description (Item nr)	Weight (Kg)	Dimensions (mm)	Band	Same colour (SEK)	Different colour (SEK)
	81002 FourUs® Booth,	154 kg		1 2 3 4 5	60.327 65.121 69.465 74.247 78.807	
	81002-S FourUs® Booth, 2 x Seat			1 2 3 4 5 8		5.146 5.961 7.945 9.565 11.189 16.057
	81002-C FourUs® Booth, 2 x Cushion			1 2 3 4 5 8		5.146 5.644 6.096 6.595 7.610 10.443
	81002-T FourUs® Booth, Top			1 2 3 4 5 8		4.421 4.860 5.239 5.841 6.901 11.322

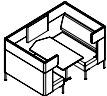
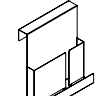
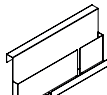
Product	Description (Item nr)	Weight (Kg)	Dimensions (mm)	Band	Same colour (SEK)	Different colour (SEK)
	81003-C FourUs® Booth, Cave			1		14.221
				2		17.442
				3		20.649
				4		23.267
				5		27.608

ACCESSORIES	Description	Weight (Kg)	Dimensions (mm)	Price (SEK)
	CABLE MANAGEMENT Pre-drilled hole in wall for cables for TV			345
	CABLE MANAGEMENT Fabric with velcro for concealing cable-right side			781
	CABLE MANAGEMENT Fabric with velcro for concealing cable, left side			781
	FOURUS LEGS Skid frame			3.742
	160800L InnoTab, FourUs, Left			3.872
	160800R InnoTab, FourUs, Right			3.872
	8501 FourUs® Pivot Table, Pivot table 138x75 (FourUs Booth)	30,6 Kg	1388 x 750 x h720 mm	11.047
	899001 FourUs® Optional Extras, TV bracket	-		3.176
	899010 FourUs® Optional Extras, Magazine holder black, 30 cm	4,9 Kg	300 x 352 mm	1.089
	899020 FourUs® Optional Extras, Magazine holder black, 70 cm	5,6 Kg	700 x 325 mm	1.484
	899100 FourUs® Optional Extras, Shelf black	5,8 Kg	L1412 mm	5.949

FourUs® Booth 2

Design by Nørgaard Design

[Content ↗](#)



FEATURES





- Private working area for 2 people. Acoustic and visual privacy.
- Uni- or multicoloured.
- Facility friendly; designed for optimal cleaning.
- Optional: Pivot table that effortlessly moves both horizontally and vertically (Nano laminate: Warm grey, Anthracite or Black).
- Frame and fittings in black, matt lacquered.
- Optional: Skid frame, Magazine holder, Shelf (h 95 cm) TV bracket.
- Electrical units are optional in sofa and in tabletop.





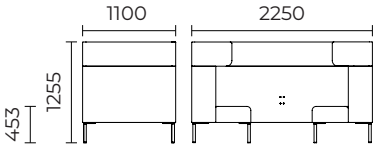

For product information visit oceefour.com ↗

For electrical accessories [go to page 228](#) ↗

For full band and colour details [go to page 238](#) ↗

Product	Description (Item nr)	Weight (Kg)	Dimensions (mm)	Band	Same colour (SEK)	Different colour (SEK)
	81042 FourUs® Booth 2,	-		1 2 3 4 5	48.260 52.098 55.574 59.397 63.046	
	81042-S FourUs® Booth 2, 2 x Seat			1 2 3 4 5 8		4.530 5.244 6.993 8.419 9.848 14.133
	81042-C FourUs® Booth 2, 2 x Cushion			1 2 3 4 5 8		4.530 4.967 5.366 5.806 6.695 9.189
	81042-T FourUs® Booth 2, Top			1 2 3 4 5 8		3.890 4.276 4.610 5.139 4.276 4.610

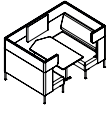
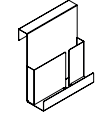
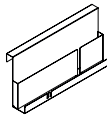
ACCESSORIES	Description	Weight (Kg)	Dimensions (mm)	Price (SEK)
	CABLE MANAGEMENT Pre-drilled hole in wall for cables for TV			345
	CABLE MANAGEMENT Fabric with velcro for concealing cable-right side			781
	CABLE MANAGEMENT Fabric with velcro for concealing cable, left side			781
	FOURUS LEGS Skid frame			3.742
	160800L InnoTab, FourUs, Left			3.872
	160800R InnoTab, FourUs, Right			3.872
	8502 FourUs® Pivot Table, Pivot table 99x75 (FourUs Booth 2)	-		11.047
	899001 FourUs® Optional Extras, TV bracket	-		3.176
	899010 FourUs® Optional Extras, Magazine holder black, 30 cm	4,9 Kg	300 x 352 mm	1.089
	899020 FourUs® Optional Extras, Magazine holder black, 70 cm	5,6 Kg	700 x 325 mm	1.484



FEATURES





- Private working area for 1-3 people. Acoustic and visual privacy.
- Delivered left or right-handed. Uni- or multicoloured.
- Facility friendly; designed for optimal cleaning.
- Optional: Pivot table that effortlessly moves both horizontally and vertically (Nano laminate: Warm grey, Anthracite or Black).
- Frame and fittings in black, matt lacquered.
- Optional: Skid frame, Magazine holder, Shelf (h 95 cm) TV bracket.
- Electrical units are optional in sofa and in tabletop.

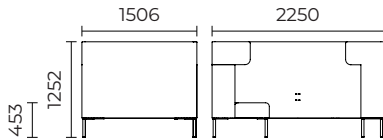

For product information visit oceefour.com ↗

For electrical accessories [go to page 228](#) ↗

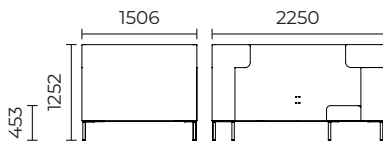



For full band and colour details [go to page 238](#) ↗





Product	Description (Item nr)	Weight (Kg)	Dimensions (mm)	Band	Same colour (SEK)	Different colour (SEK)
	87062 FourUs® Work Booth right,	154 kg		1 2 3 4 5	50.711 55.821 60.930 66.040 71.149	
	87072 FourUs® Work Booth left,	154 kg		1 2 3 4 5	50.711 55.821 60.930 66.040 71.149	
	87062-S FourUs® Work Booth right, Seat			1 2 3 4 5 8		2.574 2.981 3.973 4.784 5.597 8.030
	87072-S FourUs® Work Booth left, Seat			1 2 3 4 5 8		2.574 2.981 3.973 4.784 5.597 8.030

FourUs® Work Booth

Design by Nørgaard Design

[Content ↗](#)

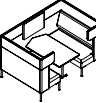
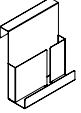
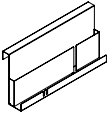
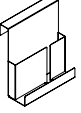
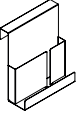
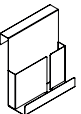
Product	Description (Item nr)	Weight (Kg)	Dimensions (mm)	Band	Same colour (SEK)	Different colour (SEK)
	87062-C FourUs® Work Booth right, Cushion			1		2.574
				2		2.823
				3		3.050
				4		3.297
				5		3.805
				8		5.222
	87072-C FourUs® Work Booth left, Cushion			1		2.574
				2		2.823
				3		3.050
				4		3.297
				5		3.805
				8		5.222
	87062-T FourUs® Work Booth right, Top			1		4.421
				2		4.860
				3		5.239
				4		5.841
				5		6.901
				8		11.322
	87072-T FourUs® Work Booth left, Top			1		4.421
				2		4.860
				3		5.239
				4		5.841
				5		6.901
				8		11.322

ACCESSORIES	Description	Weight (Kg)	Dimensions (mm)	Price (SEK)
	CABLE MANAGEMENT Pre-drilled hole in wall for cables for TV			345
	CABLE MANAGEMENT Fabric with velcro for concealing cable-right side			781
	CABLE MANAGEMENT Fabric with velcro for concealing cable, left side			781
	8503 FourUs® Pivot Table, Pivot table (FourUs Work Booth) right	22,9 Kg	1361 x 842 x H720 mm	11.047
	8504 FourUs® Pivot Table, Pivot table (FourUs Work Booth) left	22,9 Kg	1361 x 842 x H720 mm	11.047
	899001 FourUs® Optional Extras, TV bracket	-		3.176
	899010 FourUs® Optional Extras, Magazine holder black, 30 cm	4,9 Kg	300 x 352 mm	1.089
	899020 FourUs® Optional Extras, Magazine holder black, 70 cm	5,6 Kg	700 x 325 mm	1.484
	899030 FourUs® Optional Extras, Magazine holder black, 22,5 cm	-		2.839
	899040 FourUs® Optional Extras, Magazine holder white, 22,5 cm	-		2.839
	899050 FourUs® Optional Extras, Magazine holder grey, 22,5 cm	-		2.839
	899100 FourUs® Optional Extras, Shelf black	5,8 Kg	L1412 mm	5.949

FourUs® Solo

Design by Nørgaard Design

[Content ↗](#)



FEATURES





- Acoustic and visual privacy. Uni- or multicoloured.
- Facility friendly; designed for optimal cleaning.
- Inclusive black Fenix-laminate tablet (21 mm) – placed on the right side as standard.
- Standard leg frame black (RAL 7021). Optional: Castors or Skid frame.
- Electrical units are optional and will be positioned on the left or right side of sofas as standard.

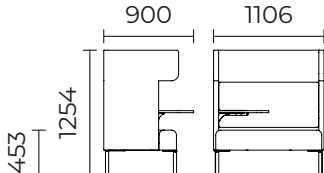

For product information visit oceefour.com ↗

For electrical accessories [go to page 228](#) ↗



For full band and colour details [go to page 238](#) ↗

Product	Description (Item nr)	Weight (Kg)	Dimensions (mm)	Band	Same colour (SEK)	Different colour (SEK)
	80016 FourUs® Solo with black tablet,	64 kg		1 2 3 4 5 8	25.783 27.601 29.203 31.004 36.139 65.571	
	80016-S FourUs® Solo with black tablet, Seat			1 2 3 4 5 8		2.512 2.923 2.975 3.218 3.451 6.683
	80016-C FourUs® Solo with black tablet, Cushion			1 2 3 4 5 8		2.512 2.923 2.975 3.218 3.451 6.683
	80016-T FourUs® Solo with black tablet, Top			1 2 3 4 5 8		2.337 3.093 3.786 4.564 5.269 7.450

FourUs® Solo

Design by Nørgaard Design

[Content ↗](#)

ACCESSORIES	Description	Weight (Kg)	Dimensions (mm)	Price (SEK)
	FOURUS LEGS Castors			3.960
	FOURUS LEGS Skid frame			3.742

FourUs® 3-Seater

Design by Nørgaard Design

[Content ↗](#)



FEATURES







- Acoustic and visual privacy. Uni- or Multicoloured.
- Facility friendly; designed for optimal cleaning.
- Optional: Skid frame, InnoTab tablet, Magazine holder, Shelf (height 95 cm).
- Electrical units are optional and will be positioned on the left or right side of sofas as standard.

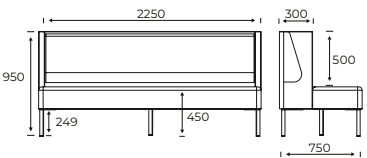

For product information visit oceefour.com ↗

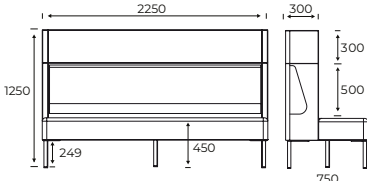
For electrical accessories [go to page 228](#) ↗

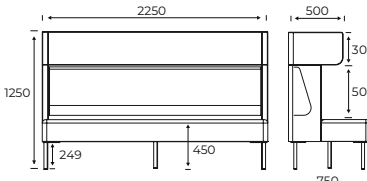

For full band and colour details [go to page 238](#) ↗

Product	Description (Item nr)	Weight (Kg)	Dimensions (mm)	Band	Same colour (SEK)	Different colour (SEK)
	80030 FourUs® 3-Seater, Bench	-		1 2 3 4 5 8	29.253 31.129 32.817 34.692 38.441 55.882	
	80031 FourUs® 3-Seater, Extension	-		1 2 3 4 5 8	34.562 36.567 38.253 39.849 44.536 66.478	
	80032 FourUs® 3-Seater, Ear	62 Kg		1 2 3 4 5 8	35.817 37.878 39.567 41.289 45.849 67.788	
	80030-S FourUs® 3-Seater, Bench, Seat			1 2 3 4 5 8		3.095 4.078 4.855 5.822 6.778 9.901

FourUs® 3-Seater

Design by Nørgaard Design

[Content ↗](#)

Product	Description (Item nr)	Weight (Kg)	Dimensions (mm)	Band	Same colour (SEK)	Different colour (SEK)
	80030-C FourUs® 3-Seater, Bench, Cushion			1		2.774
				2		2.993
				3		3.121
				4		3.392
				5		3.562
				8		6.315
	80031-T FourUs® 3-Seater, Extension, Top			1		2.776
				2		2.993
				3		3.544
				4		4.339
				5		5.138
				8		7.502
	80032-T FourUs® 3-Seater, Ear, Top			1		2.776
				2		2.993
				3		3.544
				4		4.339
				5		5.138
				8		7.502

ACCESSORIES	Description	Weight (Kg)	Dimensions (mm)	Price (SEK)
	FOURUS LEGS Skid frame			3.742
	160800L InnoTab, FourUs, Left			3.872
	160800R InnoTab, FourUs, Right			3.872
	899010 FourUs® Optional Extras, Magazine holder black, 30 cm	4,9 Kg	300 x 352 mm	1.089
	899020 FourUs® Optional Extras, Magazine holder black, 70 cm	5,6 Kg	700 x 325 mm	1.484



FEATURES

- Acoustic and visual privacy
- Touch-Down-workspace (1 Person)
- Table top in: Black, warm grey or anthracite Nano laminate (138x50 cm)
- Matching ABS edges



For product information visit oceefour.com ↗

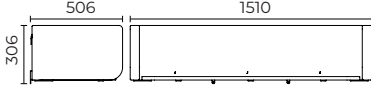

TABLE TOP

Fenix laminate



07 08 09

For full band and colour details [go to page 238](#) ↗

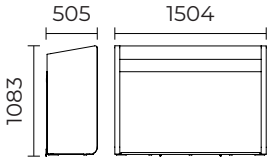
Product	Description (Item nr)	Weight (Kg)	Dimensions (mm)	Band	Same colour (SEK)
	8200E FourUs® Wallpod, Wallpod Ear	29 kg		<ul style="list-style-type: none"> 1 9.656 2 10.198 3 10.667 4 11.182 5 11.675 8 16.518 	
	8200F FourUs® Wallpod, Wallpod Cave	35 kg		<ul style="list-style-type: none"> 1 17.477 2 19.096 3 20.571 4 22.193 5 23.741 8 41.609 	



FEATURES

- Table height 74 cm – integrated castors on two legs.
- Foldable by one person without the use of tools.
- Tabletop 98 x 65 cm.
- Table top in: Black, warm gray or anthracite Nano laminate.
- Matching ABS edges.
- Electrical units are optional in tabletop.



For product information visit oceefour.com ↗

TABLE TOP

Fenix laminate



FRAME COLOURS

Standard



For electrical accessories [go to page 228](#) ↗

For full colour details [go to page 236](#) ↗

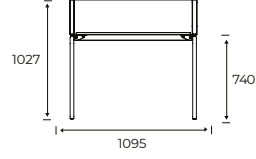
Product	Description (Item nr)	Weight (Kg)	Dimensions (mm)	Top/Band	Price (SEK)
	83022 FourUs® Worx, FourWorx	28.4		1	17.562
				2	18.228
				3	18.776
				4	19.436
				5	20.071
				8	26.571

For tabletop cutout placements go to: [Oceedesign.com/Cutout.pdf](https://oceedesign.com/Cutout.pdf)





Harc Tub



Harc Tub Meeting

Harc Tub

Design Roger Webb Associates

[Content ↗](#)



For data information, certificates and product description please refer to our website www.fourdesign.dk









- Two-tone fabric option
- 5 star base is available on request

		Dimensions (cm)		Band	Price
	HARCTUBLB1 Low Back Lounge Chair Skid Frame			1 2 3 4 5 6 7	11.186 11.573 12.151 12.922 14.277 15.818 17.366
	HARCTUBLB2 Low Back Lounge Chair 4-star Polished Aluminium Swivel & Tilt Base			1 2 3 4 5 6 7	12.151 12.538 13.115 13.887 15.242 16.783 18.331
	HARCTUBLB3 18 Kg Low Back Lounge Chair Wooden Frame			1 2 3 4 5 6 7	16.012 16.399 16.977 17.749 19.103 20.645 22.192
	HARCTUBHB1 High Back Lounge Chair Skid Frame			1 2 3 4 5 6 7	14.371 14.949 15.723 16.688 18.426 20.547 23.057
	HARCTUBHB2 High Back Lounge Chair 4-star Polished Aluminium Swivel & tilt Base			1 2 3 4 5 6 7	15.336 15.914 16.688 17.652 19.391 21.512 24.022
	HARCTUBHB3 High Back Lounge Chair Wooden Frame			1 2 3 4 5 6 7	19.198 19.775 20.549 21.514 23.252 25.373 27.883

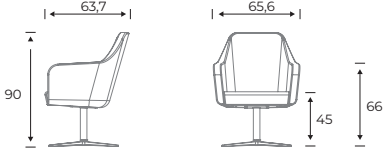

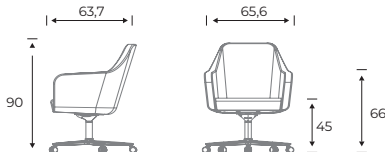

Harc Tub Meeting

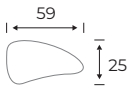
Design Roger Webb Associates

[Content ↗](#)

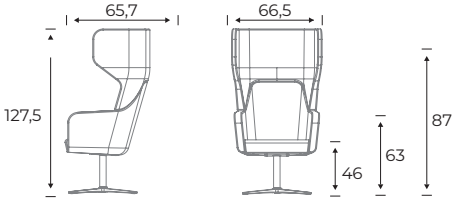
		Dimensions (cm)	Band	Price
	HARCTUBMB2 Low Back Meeting Chair 4-star Polished Aluminium Swivel & Tilt Base		1 2 3 4 5 6 7	12.151 12.538 13.115 13.887 15.242 16.783 18.331
	HARCTUBMB6 Low back meeting chair 5 star polished aluminium base with castors		1 2 3 4 5 6 7	11.186 11.573 12.151 12.922 14.277 15.818 17.366
	HARCTUHR Headrest option for all Harc Low Back Tub Chairs and Meeting Chairs		1 2 3 4 5 6 7	2.562 2.688 2.811 2.965 3.273 3.616 4.015
	TABLET Tablet option for Harc meeting with a 4 star base and Harc meeting with 5 star base and castors*			4.055

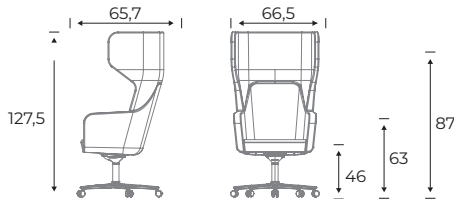
*Tablet not available on 4 and 5 star base with swivel return option

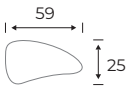
	HARCTUBMH2 High back meeting chair 4-star polished aluminium swivel & tilt base		1 2 3 4 5 6 7	15.336 15.914 16.688 17.652 19.391 21.512 24.022
	HARCTUBMH6 High back meeting chair 5-star polished aluminium base with castors		1 2 3 4 5 6 7	14.371 14.949 15.723 16.688 18.426 20.547 23.057
	TABLET Tablet option for Harc meeting with a 5 star base and castors*			4.055

*Tablet not available on 4 and 5 star base with swivel return option

Specifications & Options

- Low and high back option on all models
- Moulded foam for additional comfort and durability
- Two-tone fabric option
- Headrest option for all Harc Low Back tub chairs and Meeting chairs

Frame options

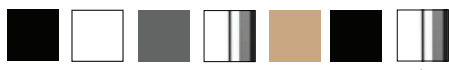



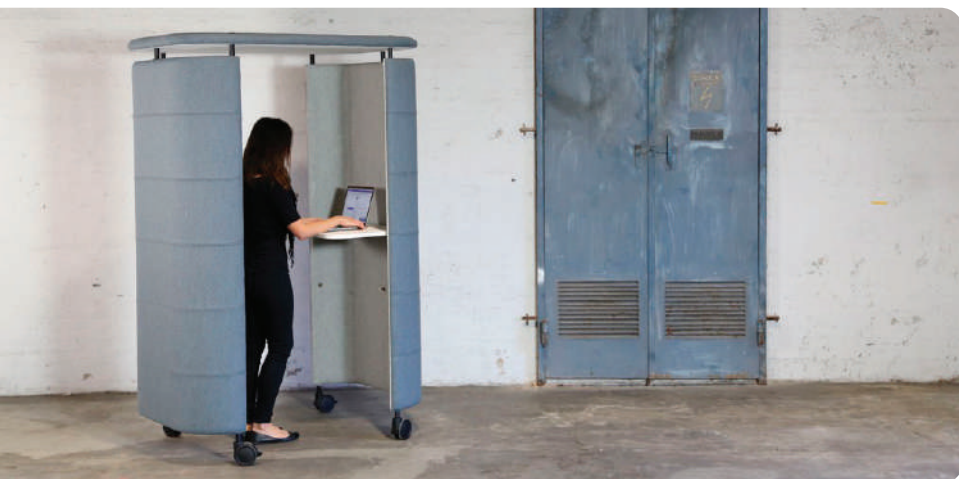

Black, White, Warm Grey, chrome, oak oiled, oak stained black, aluminium (chairs with swivel base only)



För datainformation, certifikat och produktbeskrivning, se vår webbplats www.oceefour.com

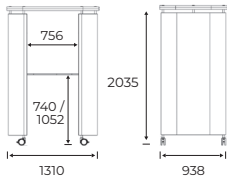

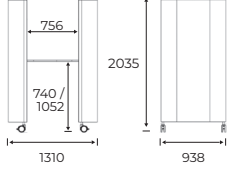
- Tillgänglig i två storlekar
- Två olika bordshöjder

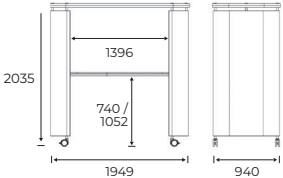
		Mått (mm)	Grupp	Pris
	62000 Inno Pod Inkl. bordsskiva 81 x 49 cm 110 kg		1	27.037
			2	28.584
	62001 Inno Pod Inkl. bordsskiva 81 x 118 cm 114 kg		1	28.485
			2	30.032
	62003 Inno Pod Big Inkl. bordsskiva 81 x 180 cm 126 kg		1	35.504
			2	37.279

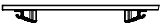
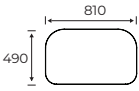
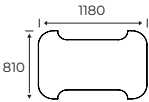
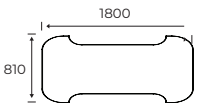
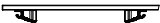
Tillbehör		Mått (mm)	Bordsskiva	Pris
	62100 Bordsskiva (1 stolupphängning kan monteras)		07 ●	2.593
			08 ●	
			09 ●	
62101 Bordsskiva (1 stolupphängning kan monteras)		07 ●	5.985	
		08 ●		
		09 ●		
62103 Bordsskiva (Stolupphängning kan inte monteras)		07 ●	9.651	
		08 ●		
		09 ●		
	CS1 Stolupphängning till FourCast2 Four, FourCast2 Line, FourSure 44, FourSure 88, FourSure 11, FourSure 99, Four Stools, Four Seating Benches 0,288kg			255
	CS2 Stolupphängning till Four Cast Wheeler, Four Sure 66 0,288kg			255



Let's furnish the world *better*

When we design a product, we consider every stage of the products lifecycle to ensure we are making responsible choices throughout all areas of the company. Each stage has the possibility to effect the next and so the whole picture is considered. Responsible manufacturing not only looks at the materials and where they are sourced, but also the manufacturing site and resources consumed; the use and durability of the product; the packaging and delivery service; as well as the product's end-of-life.

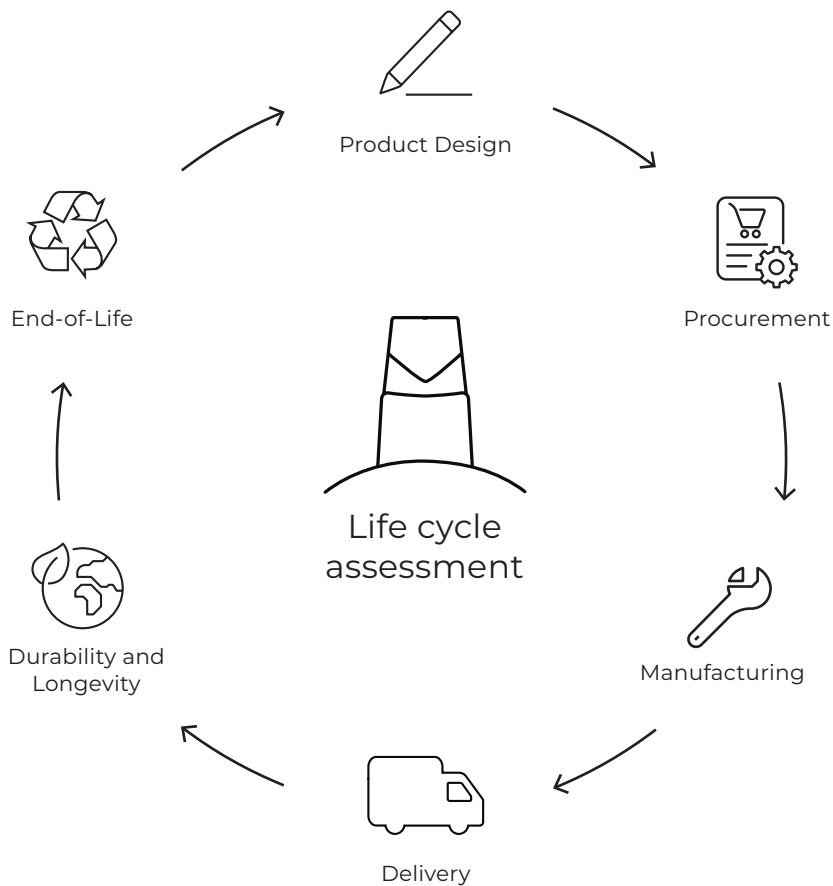

Our furniture are
tested for Globally use





The following images are for illustrative purposes only. The finished product will contain standardised sockets based on the country of your choice. Please note prices include our team supplying products with prepared hole for unit installation. Please note, for tables, the electrical unit will be delivered separately, please follow the assembly instructions provided with your order to install the unit. For soft seating, the electrical unit will be preinstalled.

EVOLINE		PRICE (SEK)
	<p>EVOLINE ONE BLACK (APO00101)</p> <p>Ø60 Socket, 13 A, contactprotected. Power supply module with cable and connector, plug, cable length 3.0 m, black with lock. Power supply module with cable and connector, socket, cable length 3.0 m, black without lock.</p>	<p>FourReal® FourReal® A Four®Learning Four®Eating Four®Meeting Four®Mat FourLikes® T FourLikes® FourLikes® Meet FourLikes® Scooter (1400/2100)</p> <p>FourUs® Work/Booth (tabletop) Harc Sofa/Modular Harc Booth tabletop FourPeople Sofas/Booths/Huts</p> <p>1.865</p>
	<p>EVOLINE ONE WHITE (APO00102)</p> <p>Ø60 Socket, 13 A, contactprotected. Power supply module with cable and connector, plug, cable length 3.0 m, black with lock. Power supply module with cable and connector, socket, cable length 3.0 m, black without lock.</p>	<p>FourReal® FourReal® A Four®Learning Four®Eating Four®Meeting Four®Mat FourLikes® T FourLikes® FourLikes® Meet FourLikes® Scooter (1400/2100)</p> <p>FourUs® Work/Booth (tabletop) Harc Sofa/Modular Harc Booth tabletop FourPeople Sofas/Booths/Huts</p> <p>1.865</p>
	<p>EVOLINE ONE USB BLACK (APO00201)</p> <p>USB socket, charging function only. Rated output current: 2100 mA; Type A + C. Power supply module with cable and connector, plug, cable length 3.0 m, black with lock. Power supply module with cable and connector, socket, cable length 3.0 m, black without lock.</p>	<p>FourReal® FourReal® A Four®Learning Four®Eating Four®Meeting Four®Mat FourLikes® T FourLikes® FourLikes® Meet FourLikes® Scooter (1400/2100)</p> <p>FourUs® Work/Booth (tabletop) Harc Sofa/Modular Harc Booth tabletop FourPeople Sofas/Booths/Huts</p> <p>2.566</p>
	<p>EVOLINE ONE USB WHITE (APO00202)</p> <p>USB socket, charging function only. Rated output current: 2100 mA; Type A + C. Power supply module with cable and connector, plug, cable length 3.0 m, black with lock. Power supply module with cable and connector, socket, cable length 3.0 m, black without lock.</p>	<p>FourReal® FourReal® A Four®Learning Four®Eating Four®Meeting Four®Mat FourLikes® T FourLikes® FourLikes® Meet FourLikes® Scooter (1400/2100)</p> <p>FourUs® Work/Booth (tabletop) Harc Sofa/Modular Harc Booth tabletop FourPeople Sofas/Booths/Huts</p> <p>2.566</p>
	<p>EVOLINE FRAMEDOCK BLACK (APF3010102)</p> <p>2 x Socket Modules, 13 A, contactprotected. 1 x Socket Modules, USB socket, charging function only. Rated output current: 2100 mA; Type A + C. Power supply module with cable and connector, plug, cable length 3.0 m, black with lock. Power supply module with cable and connector, socket, cable length 3.0 m, black with lock.</p>	<p>FourReal® FourReal® A Four®Learning Four®Eating Four®Meeting Four®Mat</p> <p>3.370</p>
	<p>EVOLINE FRAMEDOCK SILVER ANODISED (APF3030102)</p> <p>2 x Socket Modules, 13 A, contactprotected. 1 x Socket Modules, USB socket, charging function only. Rated output current: 2100 mA; Type A + C. Power supply module with cable and connector, plug, cable length 3.0 m, black with lock. Power supply module with cable and connector, socket, cable length 3.0 m, black with lock.</p>	<p>FourReal® FourReal® A Four®Learning Four®Eating Four®Meeting Four®Mat</p> <p>3.370</p>

EVOLINE

PRICE (SEK)



EVOLINE DOCKFIX BLACK (APD3010102)

2 x Socket Modules, 13 A, contactprotected. 1 x Socket Modules, USB socket, charging function only. Rated output current: 2100 mA; Type A + C. Power supply module with cable and connector, plug, cable length 3.0 m, black with lock. Power supply module with cable and connector, socket, cable length 3.0 m, black with lock. With sidebrackets for sub-mounting.

FourUs®
FourUs® Booth
FourUs® Work Booth
FourUs® Solo
FourUs® 3 Seater
FourUs® Corner

3,668



CHAIRS

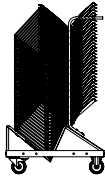

CHAIR TROLLEY - 200X0

Chair trolley for:

FourSure® 44
 FourSure® 44 Armrest
 FourSure® 88
 FourSure® 88 Armrest
 FourCast® 2 Four
 FourCast® 2 Four Armrest
 FourCast® 2 Line
 FourCast® 2 Line Armrest

200A0
 200C0
 200F0
 200I0

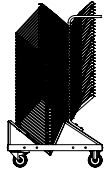

CHAIR TROLLEY - 200X0

Chair trolley for:

FourCast® 2 Four Seat/Fully
 FourCast® 2 Four Seat/Fully Arm
 FourCast® 2 Line Seat/Fully
 FourCast® 2 Line Seat/Fully Arm
 FourCast® 2 Line Veneer
 FourSure® 44 Inside/Seat/Fully
 FourSure® 44 Seat/Arm
 FourSure® 44 Inside/Arm
 FourSure® 88 Seat
 FourSure® 88 Inside
 FourSure® 88 Seat/Inside Arm
 Share Basic without / seat upholstery

20020
 20030
 20060
 20090
 20070
 200B0
 200E0
 200D0
 200G0
 200H0
 200J0
 20060



SACK TROLLEY - 200X1

Chair trolley for:

FourCast® 2 Four
 FourCast® 2 Line
 FourSure® 44
 FourSure® 88

20011
 20051
 200A1
 200F1

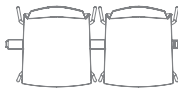

LINKING DEVICE

Chair linking under seat

FourCast® 2 Four/Seat
 FourCast® 2 Line/Seat
 FourSure® 44
 FourSure® 88
 FourCast® 2 Four/Fully
 FourCast® 2 Line/Fully
 FourSure® 44 Seat/Inside
 FourSure® 88 Seat/Inside



LINKING DEVICE

Chair linking on frame

FourCast® 2 Line
 FourSure® 88

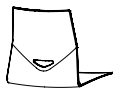

GRIP HOLE

Grip hole is available for chairs without inside – and full upholstery.

GRIP

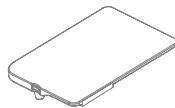

INNO

Inno® Note – A slim writing tablet matches a 13" laptop and has integrated cupholder. 225 x 325 x 10 mm (1,4 kg)

FourCast® 2 Four
 FourCast® 2 Line
 FourSure® 44
 FourSure® 88











INNO

Inno® Tab - Writing tablet with integrated with integrated cup holder and dashboard for tablet and phone. 520 x 320 x 23 mm (2,7 kg)

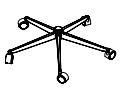
FourCast® 2 Wheeler
 FourSure® 66
 FourMe® 66
 FourCast® 2 Audi
 FourSure® Audi

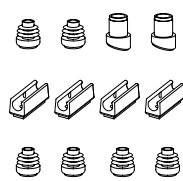
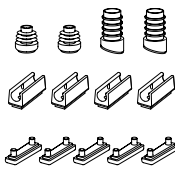
CHAIRS

	<p>INNO®NOTE TROLLEY - 20100007 Trolley for Inno®Note. Room for 51 Inno®Notes</p>	<p>FourCast® 2 Four FourCast® 2 Line FourSure® 44 FourSure® 88</p>	<p>20100007</p>
 <p>B</p>	<p>INNO Inno® Tab B – Writing tablet and powder coated frame with integral cup holder and coat hook. 585 x 308 mm.</p>	<p>White Antchracite</p>	
 <p>C</p>	<p>INNO Inno® Tab C – Writing tablet and powder coated frame with integral cup holder and coat hook. 475 x 278 mm.</p>	<p>White Antchracite</p>	
	<p>HOOK</p>	<p>FourCast2® Wheeler FourSure® 66</p>	
	<p>GASFOOT Incl. foot ring</p>	<p>FourCast® 2 Wheeler FourSure® 66 FourMe® 66</p>	<p>GASFOOT GASFOOT GASFOOT</p>
	<p>WHEELS</p>	<p>FourCast® 2 Evo FourCast® 2 XL/XL Plus FourSure® 99 FourMe® 99</p>	
	<p>STANDARD POLYIMIDE GLIDES Chair height + 0,2 cm</p>	<p>FourCast® 2 Wheeler FourSure® 66 FourMe® 66</p>	
	<p>TEFLON GLIDERS Set of 4 pcs. Chair height + 0,2 cm</p>	<p>FourCast® 2 Four / Eco FourCast® 2 Line / Eco FourCast® 2 Counter/High / Eco FourCast® 2 Counter/High Four / Eco FourCast® 2 One FourSure® 44 / Eco FourSure® 88 / Eco FourSure® 90/105/Eco FourSure® 11 + FourSure® 99 FourMe® 44 + FourMe® 88 FourMe® 11 + FourMe® 99 Four® Stools Four® Seating Benches</p>	
	<p>FELT GLIDES Set of 4 pcs. Chair height + 0,2 cm</p>	<p>FourCast® 2 Four / Eco FourCast® 2 Line / Eco FourCast® 2 Counter/High / Eco FourCast® 2 Counter/High Four / Eco FourCast® 2 One FourCast® 2 Evo FourCast® 2 XL/Plus FourCast® 2 Lounge FourSure® 44 / Eco FourSure® 88 / Eco FourSure® 90/105 / Eco FourSure® 11 + FourSure® 99 FourMe® 44 + FourMe® 88 FourMe® 11 + FourMe® 99 FourMe® Lounge</p>	
	<p>FELT GLIDES FOR WOODEN LEGS Set of 4 pcs. Chair height + 0,2 cm.</p>	<p>FourCast® 2 Four FourSure® 44 FourMe® 44</p>	

CHAIRS

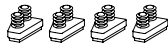

**FELT GLIDES
STOOLS & BENCHES
WOODEN LEGS**
4-pack. Sitthöjd + 0,2 cm

Four® Stools wooden legs
Four® Seating Benches wooden legs



FEET/GLIDERS/CASTORS
Noise reducing ferrule with felt.
Set of 4 pcs. Chair height + 1 cm

FourCast® 2 Four
FourCast® 2 One
FourSure® 44
FourSure® 11
FourMe® 44
FourMe® 11

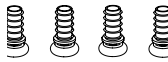

FEET/GLIDERS/CASTORS
Noise reducing ferrule with big
diameter (reduces pressure marks).
Set of 4 pcs. Chair height + 0,8 cm

FourCast® 2 Four
FourCast® 2 One
FourSure® 44
FourSure® 11
FourMe® 44
FourMe® 11



**CHAIR SEAT-ROW -
ACSR0201**
11 mm - no. 1 - 25

FourCast® 2 Line
Eco Label FourCast® 2 Line
Fire Retardent FourCast® 2 Line
FourSure® 88
Eco Label FourSure® 88

ACSR0201



**CHAIR SEAT-ROW -
ACSR0202**
11 mm - no. 26 - 50

FourCast® 2 Line
Eco Label FourCast® 2 Line
Fire Retardent FourCast® 2 Line
FourSure® 88
Eco Label FourSure® 88

ACSR0202



**CHAIR SEAT-ROW -
ACSR0101**
16 mm - no. 1 - 25

FourCast® 2 Four
Eco Label FourCast® 2 Four
Fire Retardent FourCast® 2 Four
FourSure® 44
Eco Label FourSure® 44

ACSR0101















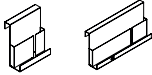

**CHAIR SEAT-ROW -
ACSR0102**
16 mm - no. 26 - 50

FourCast® 2 Four
Eco Label FourCast® 2 Four
Fire Retardent FourCast® 2 Four
FourSure® 44
Eco Label FourSure® 44

ACSR0102

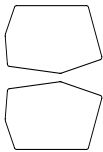
TABLES			
	<p>TABLE TROLLEY - 20100001 Trolley for 10 folded tables or 7 round tables, including strap. 20 Kg. L: 172 x W: 55 x H: 98 cm Folded Table: 15 cm</p>	<p>Four® Learning Four® Eating FourReal® 74 FourReal® 90 FourReal® 105 FourReal® 741 Flake</p>	<p>20100001 20100001 20100001 20100001 20100001 20100001</p>
	<p>CHAIR SUSPENSION Chair suspension for FourCast2 Four, FourCast2 Line, FourSure 44, FourSure 88, FourSure 11, FourSure 99, Four Stools, Four Seating Benches</p>	<p>Four® Learning Four® Eating Four® Meeting FourReal® 74 FourReal® 90 FourReal® 105 FourReal® 741 Flake</p>	<p>CS1</p>
	<p>CHAIR SUSPENSION Chair suspension for FourCast2 Wheeler, FourSure 66</p>	<p>Four® Learning Four® Eating FourMeeting FourReal® FourReal® 90 FourReal® 105 FourReal® 741 Flake</p>	<p>CS2</p>
	<p>CABLE CUT OUT Cable duct, aluminum. Cable duct placed in apron</p>	<p>Four® Learning Four® Eating Four® Meeting FourReal®</p>	<p>CD</p>
	<p>CD Cable duct, single, incl., hole in table top. Aluminium.</p>	<p>Four® Mat</p>	<p>CD1</p>
	<p>CD Cable duct, double, incl., hole in table top. Aluminium.</p>	<p>Four® Mat</p>	<p>CD2</p>
	<p>FRLINK Linking Device, set of 4 pcs - 2 x he, 2 x she per table</p>	<p>Four® Learning Four® Eating Four® Meeting FourReal®</p>	
	<p>CASTORS Castors height adjustable wheel in black with brakes. Set of 4 pieces</p>	<p>FourFold®</p>	<p>CF</p>
	<p>CASTORS</p>	<p>Four® Resting</p>	
	<p>HOLE Pre-drilled hole for power</p>	<p>All tables</p>	
<p>60 cm x 13 cm x 15 cm 80 cm x 13 cm x 15 cm</p>	<p>FLOWER BOX FourReal A 74 + 90 FourReal A.XL 74 + 90 FourReal AV</p>	<p>Black 600 mm Black 800 mm</p>	<p>699000008 699000005</p>
	<p>TOP-SHELF FourReal A 74 + 90 FourReal A.XL 74 + 90 FourReal AV</p>	<p>White 600 mm x 205 mm Black 600 mm x 205 mm Grey 600 mm x 205 mm</p>	<p>699000001 699000002 699000003</p>

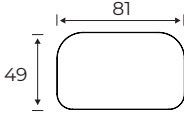
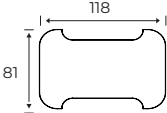
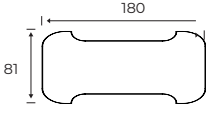

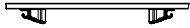
SOFT SEATING			
	LINKING DEVICE 2 her x 2 him	FourLikes®	
	LINKING DEVICE Linking Device	FourLikes® Scooter	
	FEET Feet for FourLikes Scooter	FourLikes® Scooter	
	WHEELS	FourLikes® Scooter	
	INNO® TAB LEFT Black Fenix-Laminate <i>*Only with standard legs</i> L: 480 x W: 300 mm	FourUs® FourUs® 3-seater FourUs® Booth 2 FourUs® Booth	16082-1A1-92
	INNO® TAB RIGHT Black Fenix-Laminate <i>*Only with standard legs</i> L: 480 x W: 300 mm	FourUs® FourUs® 3-seater FourUs® Booth 2 FourUs® Booth	16072-1A1-92
	SHELF Black Fenix-Laminate L: 1500 x W: 300 mm Heigh from floor: 905 mm	FourUs® FourUs® Booth FourUs® Work Booth	8990J-101-13
	CASTORS	FourUs® FourUs® Solo	8990K-100-00
	SKID FRAME	FourUs® FourUs® 3-seater FourUs® Booth 2 FourUs® Booth FourUs® Corner FourUs® Solo	8990M-500-00
	MAGAZINE HOLDER W: 300 mm / 700 mm	FourUs® FourUs® 3-seater FourUs® Booth 2 FourUs® Booth FourUs® Corner FourUs® Work Booth	8990T-000-99 / 8990T-001-99
	MAGAZINE HOLDER, BLACK B: 225 x D: 95 x H: 970 mm	FourUs® Booth FourUs® Booth 2 FourUs® Work Booth	8990T-B00-99
	MAGAZINE HOLDER, WHITE B: 225 x D: 95 x H: 970 mm		8990T-C00-99
	MAGAZINE HOLDER, GREY B: 225 x D: 95 x H: 970 mm		8990T-K00-99
	PIVOT TABLE Black Fenix-laminate	FourUs® Booth 2 FourUs® Booth	85045

SOFT SEATING					
	PIVOT TABLE, RIGHT L: 1380 x B: 750 x H: 720 mm	FourUs® Work Booth			870GS-106
	PIVOT TABLE, LEFT L: 1380 x B: 750 x H: 720 mm				870GS-107
	TV BRACKET Option hidden cable	FourUs® Booth 2 FourUs® Booth FourUs® Work Booth			8100T-100-00
	CABLE MANAGEMENT TV Pre-drilled hole in wall for cables	FourUs® Booth 2 FourUs® Booth FourUs® Work Booth			
	CABLE MANAGEMENT STANDARD Fabric with velcro for concealing cable underneath the table	FourUs® Booth 2 FourUs® Booth FourUs® Work Booth			
ACOUSTIC					
	TABLE TOP (1 pcs. chair suspension) Colours: 08 Warm grey, 38 Antracit, 10 Black	InnoPod®	08 ● 38 ● 10 ●		62100
	TABLE TOP (1 pcs. chair suspension) Colours: 08 Warm grey, 38 Antracit, 10 Black	InnoPod®	08 ● 38 ● 10 ●		62101
	TABLE TOP (No chair suspension) Colours: 08 Warm grey, 38 Antracit, 10 Black	InnoPod®	08 ● 38 ● 10 ●		62103
	CS1 Chair suspension for FourCast2 Four, FourCast2 Line, FourSure 44, FourSure 88, FourSure 11, FourSure 99, Four Stools, Four Seating Benches	InnoPod®			23099-002-99
	CS2 Chair suspension for FourCast2 Wheeler, FourSure 66	InnoPod®			23099-003-99

Chair shell colours





 01 / SNOW RAL 9010	 14 / WHITE Fire Retardant RAL 9010	 02 / EBONY BLACK NCS S 9000-N	 03 / ANTHRACITE RAL 7015
 05 / AQUA NCS S 4020-B	 17 / PINE NCS S 5005-B80G	 18 / MOSS NCS S 5010-G70Y	 12 / TERRACOTTA NCS S 4510-Y60R
 13 / CLAY NCS S 6005-Y20R	 10 / BEACH NCS S 2502-Y	 09 / OLIVE NCS S 2040-G80Y	 08 / ORANGE NCS S 2070-Y70R
 07 / ORIENTAL RED NCS S 1580-R	 06 / JUNGLE GREEN NCS 4050-G40Y	 31 (03) / OAK	 32 (04) / OAK BLACK

Chair frame colours



 C (02) / MATT WHITE RAL 9010	 B (01) / MATT BLACK RAL 7021	 K (03) / STONE GREY RAL 7039	 9 / BLACK
 E / ANTHRACITE RAL 7024 gl.5	 M / AQUA S4020-B IGP 581 TA 52240 A 00	 D / PINE IGP 591 TA 79407 R10	 F / MOSS IGP 591 TA 64445 R10
 7 / TERRACOTTA IGP 591 TA 83991 R10	 A / CLAY IGP 591 TA 79406 R10	 T / BEACH IGP 681 TA 77644 A 00	 S / OLIVE RAL 7042 gl. 5
 N / ORANGE IGP 681 TA 21349 A 00	 Q / ORIENTAL RED IGP 581 TA 33080 A 00	 O / JUNGLE GREEN IGP 681 TA 64014 A 00	
 4 / ALUMINIUM	 5 / MAT CHROME	 6 / CHROME	
 P / OAK BLACK OILED	 V / OAK LACQUERED BLACK	 L / OAK OILED	 U / OAK CLEAR MATT LACQUERED

Share colours









SHARE SEAT/BACK COLOURS

 19 / DENIM NCS S 6020-B10G	 20 / CLARET NCS S 7010-R10B
 02 / EBONY BLACK NCS S 9000-N	 13 / CLAY NCS S 6005-Y20R
	 10 / BEACH NCS S 2502-Y

SHARE BACK COVER COLOURS

 19 / DENIM NCS S 6020-B10G	 20 / CLARET NCS S 7010-R10B	 21 / TEAL NCS S 5030-B10G	 22 / ROSE NCS S 2040-R20B
 02 / EBONY BLACK NCS S 9000-N	 13 / CLAY NCS S 6005-Y20R	 10 / BEACH NCS S 2502-Y	



Tabletops

 01 / WHITE W980 LAMINATE	 02 / LIGHT GREY EGGER U763 LAMINATE	 03 / GREY EGGER U732 LAMINATE
 04 / WHITE W980 DECOR	 05 / LIGHT GREY EGGER U763 DECOR	 06 / GREY EGGER U732 DECOR
 07 / WARM GREY ARPA FENIX NANO 0718	 08 / ANTRACIT ARPA FENIX NANO 0724	 09 / BLACK ARPA FENIX NANO 0720
 10 / BLACK 4023 LINOLEUM	 20 / WHITE COMPACT LAMINATE F2255	

FOUR MAT TABLE

 71 / MAPLE VENEER	 72 / WALNUT VENEER
 70 / BEECH VENEER	 79 / OAK VENEER



HARC TUB TABLE

 68 / BLACK LAMINATE
 43 / OAK LAMINATE





OUTDOOR TABLETOPS

 20 / WHITE COMPACT LAMINATE F2255	 57 / LIGHT GREY COMPACT LAMINATE F7927
--	---

Table frames

 C / MATT WHITE RAL 9010	 B / MATT BLACK RAL 7021	 K / STONE GREY RAL 7039
 E / ANTHRACITE RAL 7024 gl.5	 6 / CHROME	 4 / ALUMINIUM
 V / OAK LACQUERED BLACK	 U / OAK CLEAR MATT LACQUERED	

OUTDOOR FRAMES

 H / WHITE SMOOTH	 J / WHITE ROUGH	 G / BLACK SMOOTH	 I / BLACK ROUGH
---	--	---	--

This is just a selection of the cover options available. We are able to source alternative fabrics. Please contact info@fourdesign.dk for details.

Disclaimer – This fabric can be used on the listed products, but we believe that a better finish can be achieved from other fabric selections.

Shade – Only certain shades of the fabric are appropriate for use on these products. Please contact us for details.

Sample – Our upholstery experts will sample the suitability of this material range upon request.

FABRIC SUPPLIERS:

www.camirafabrics.com, www.gabriel.dk, www.kvadrat.dk

InnoPod®

Band 1

Go Check, Main Line Flax, Main Line Plus, Patina, Step Melange

Band 2

Crisp, Europost2, Fame, Select, Chili, Nejma, Passion

Fabricks™

Band 3

Blazer Lite, *Blazer

























































































Tessellate





Band 1: Tempt

Band 3: Blazer Lite

Band 5: Canvas

		Sustainability factor	Soft Seating/ RoomInRoom	Harc Tub High Back/FourLikes Meet 1400+700	Fully Upholstered FourCast/FourSure	FourMe	Seat & Inner Upholstered FourCast/FourSure
Band 1							
Aspect	Camira	♥ ♻️ ↓	Yes	Yes	Yes	Yes	Yes
Advantage	Camira	♥ ♻️	Yes	Yes	Yes	No	Yes
Atlas	Kvadrat	♥ ♻️	Yes	Shade	Shade	Shade	Shade
Canopy	Camira	♥ ♻️	Yes	FLM 700+1400 only	Yes	Yes	Yes
Clara 2	Kvadrat	♥ ♻️	Yes	Shade	Yes	Yes	Yes
Connect	Gabriel	♥ ♻️ ♻️ ↓	Yes	Yes	Yes	Yes	Sample
Cura	Gabriel	♥ ♻️ ♻️ ↓	Yes	SHADE	Yes	Yes	Yes
Era	Camira	♥ ♻️	Yes	Yes	Yes	Yes	Yes
Event	Gabriel	♥ ♻️	No	No	Yes	Yes	Sample
Felicity	Gabriel	♥ ♻️ ♻️ ↓	Yes	SHADE	Yes	Yes	No
Field 2	Kvadrat	♥ ♻️ ♻️ ↓	Disclaimer	No	Disclaimer	Disclaimer	Yes
Go Check	Gabriel	♥ ♻️ ♻️ ↓	Yes	SHADE	Yes	Yes	Yes
Go Couture	Gabriel	♥ ♻️ ♻️ ↓	Yes	SHADE	Yes	Yes	Yes
Go Uni	Gabriel	♥ ♻️ ♻️ ↓	Yes	SHADE	Yes	Yes	No
Gravity	Camira	♥ ♻️ ↓	No	No	Disclaimer	Disclaimer	Disclaimer
Halcyon Aspen	Camira	♥ ♻️	Yes	No	Yes	No	No
Halcyon Blossom	Camira	♥ ♻️	Yes	No	Yes	No	No
Halcyon Cedar	Camira	♥ ♻️	Yes	No	Yes	No	No
Main Line Plus	Camira	♥ ♻️	Yes	Yes	Yes	Yes	Yes
Main Line Flax	Camira	♥ ♻️	Yes	Yes	Yes	Yes	Yes
Manila	Camira	♥ ♻️	Yes	No	Yes	No	No
Manhattan	Camira	♥ ♻️ ♻️ ↓	Yes	No	Yes	Yes	No
Patina	Camira	♥ ♻️ ♻️ ↓	Yes	Yes	Yes	Yes	Yes
Phoenix	Camira	♥ ♻️ ♻️ ↓	No	No	Disclaimer	Disclaimer	Disclaimer
Quest	Camira	♥ ♻️ ♻️ ♻️ ↓	Yes	Yes	Yes	Yes	Yes
Repetto	Gabriel	♥ ♻️ ♻️ ♻️ ↓	Yes	SHADE	Yes	Yes	No
Rivet	Camira	♥ ♻️ ♻️ ♻️ ↓	No	No	Disclaimer	Disclaimer	Disclaimer
Step	Gabriel	♥ ♻️ ♻️ ♻️ ↓	Yes	Yes	Yes	Yes	Yes
Step Melange	Gabriel	♥ ♻️ ♻️ ♻️ ↓	Yes	Yes	Yes	Yes	Yes
Tempt	Gabriel	♥ ♻️ ♻️ ♻️ ↓	Yes	shade	Yes	Yes	No
Tonal	Gabriel	♥ ♻️ ♻️ ♻️ ↓	Sample	Sample	Yes	Yes	Sample
Urban	Camira	♥ ♻️ ♻️ ♻️ ↓	No	No	No	No	No
Vita Vinyl	Camira	♥ ♻️ ♻️ ♻️ ↓	Yes	Sample	Yes	No	Yes
Valencia	Spradling	♥ ♻️ ♻️ ♻️ ↓	Yes	Harc Tub only	Yes	No	Yes
Xtreme	Camira	♥ ♻️ ♻️ ♻️ ↓	Yes	Yes	Yes	Yes	Yes
Band 2							
Aquarius	Camira	♥ ♻️ ♻️ ♻️ ↓	Yes	Yes	Yes	Yes	No
Blazer*	Camira	♥ ♻️ ♻️ ♻️ ↓	Yes	Yes	Yes	Yes	Yes
Chili	Gabriel	♥ ♻️ ♻️ ♻️ ↓	Yes	Yes	Yes	Yes	Yes
Contour	Gabriel	♥ ♻️ ♻️ ♻️ ↓	Sample	Sample	Sample	Sample	No
Crisp	Gabriel	♥ ♻️ ♻️ ♻️ ↓	Yes	Yes	Yes	Yes	Yes
Deca	Camira	♥ ♻️ ♻️ ♻️ ↓	Yes	No	Sample	No	No
Europost 2	Gabriel	♥ ♻️ ♻️ ♻️ ↓	Yes	No	Yes	Yes	Yes
Fame	Gabriel	♥ ♻️ ♻️ ♻️ ↓	Yes	Yes	Yes	Yes	Yes
Fame Hybrid	Gabriel	♥ ♻️ ♻️ ♻️ ↓	Yes	Yes	Yes	Yes	Yes
Harmony	Gabriel	♥ ♻️ ♻️ ♻️ ↓	Yes	Yes	Yes	Yes	Yes
Hi-Tech	Camira	♥ ♻️ ♻️ ♻️ ↓	No	No	Sample	Sample	Sample
Honeycomb	Camira	♥ ♻️ ♻️ ♻️ ↓	Yes	No	No	No	No
Hemp	Camira	♥ ♻️ ♻️ ♻️ ↓	Yes	Yes	Yes	Yes	No
Intervene Plain	Camira	♥ ♻️ ♻️ ♻️ ↓	Yes	No	Yes	No	No
Intervene Texture	Camira	♥ ♻️ ♻️ ♻️ ↓	Yes	No	Yes	No	No
Just	Gabriel	♥ ♻️ ♻️ ♻️ ↓	Sample	Sample	Yes	Yes	Sample
Kyoto	Camira	♥ ♻️ ♻️ ♻️ ↓	Square units	No	No	No	No
Landscape Balance	Camira	♥ ♻️ ♻️ ♻️ ↓	Yes	Sample	Yes	Yes	No
Landscape Contact	Camira	♥ ♻️ ♻️ ♻️ ↓	Yes	Sample	Yes	Yes	No
Medley	Gabriel	♥ ♻️ ♻️ ♻️ ↓	Yes	Yes	Yes	Yes	Yes
Noma	Gabriel	♥ ♻️ ♻️ ♻️ ↓	Yes	Yes	Yes	Yes	Yes
Oxygen (MOQ)	Camira	♥ ♻️ ♻️ ♻️ ↓	Yes	Yes	Yes	Yes	No
Oceanic	Camira	♥ ♻️ ♻️ ♻️ ↓	Yes	Sample	Yes	Yes	Sample
Passion	Gabriel	♥ ♻️ ♻️ ♻️ ↓	Yes	Yes	Yes	Yes	Yes
Regent (MOQ)	Camira	♥ ♻️ ♻️ ♻️ ↓	Yes	No	No	No	No

	Sustainability factor	Soft Seating/ RoomInRoom	Harc Tub High Back/FourLikes Meet 1400+700	Fully Upholstered FourCast/FourSure	FourMe	Seat & Inner Upholstered FourCast/FourSure
Band 2 (cont)						
Remix	Kvadrat  	Yes	Yes	Yes	Yes	Yes
Rhythm	Gabriel 	No	No	No	No	No
Runner	Gabriel   ↓	No	No	No	No	Yes
Select	Gabriel  	Yes	Yes	Yes	Yes	Yes
Savoy	Gabriel   ↓	Yes	No	No	No	No
Silk	Camira    ↓	Yes	Yes	Yes	Yes	Yes
Sumi	Camira  	Yes	Yes	Yes	Yes	Yes
Synergy	Camira   	Yes	Yes	Yes	Yes	Yes
Track	Camira   ↓	Yes	No	No	No	No
X2	Camira    ↓	Yes	Yes	Yes	Yes	Yes
Yoredale	Camira 	Yes	Yes	Yes	Yes	Yes
24/7 +	Camira	Sample	Sample	Yes	Yes	Sample
24/7 Flax	Camira  	Yes	Yes	Yes	Yes	Yes
Band 3						
Armadillo	Camira  	Yes	Yes	Yes	Yes	No
Atlantic	Gabriel  	Yes	Shade	Yes	Yes	Yes
Bond	Gabriel    ↓	Yes	Yes	Yes	Yes	Sample
Breeze & Breeze Fus.	Gabriel  	Yes	Yes	Yes	Yes	Yes
Hebden (MOQ)	Camira   	Yes	Yes	Yes	Yes	No
Illusion	Nevotex 	Yes	Sample	Yes	Yes	Yes
Individuo	Camira  	Yes	Yes	Yes	Yes	No
Mainline Flax Stripe	Camira   	Yes	Sample	Yes	Yes	No
Gaja Classic	Gabriel  	Yes	Yes	Yes	Yes	Yes
Rondo	Gabriel    ↓	Yes	Shade	Yes	Yes	Sample
Melange Nap	Kvadrat  	Yes	Shade	Yes	Yes	Shade
Re-wool	Kvadrat    ↓	Yes	Yes	Yes	Yes	Yes
Zap	Camira  	Yes	Yes	Yes	Yes	No
Band 4						
Capture	Gabriel  	Yes	Yes	Yes	Yes	Yes
Craggan Flax	Camira  	Yes	Harc Tub only	Yes	Yes	No
Divina Melange 2	Kvadrat   	Yes	Yes	Yes	Yes	Yes
Mood	Gabriel  	Yes	Harc Tub only	Sample	Sample	Sample
Nettle- Aztec	Camira  	Yes	Harc Tub only	Yes	Yes	No
Silvertex	Camira	Yes	Yes	Yes	Yes	Yes
Band 5						
Canvas 2	Kvadrat  	Yes	Shade	Shade	Shade	Shade
Criss Cross	Gabriel  	Yes	Sample	Yes	Yes	No
Fiord	Kvadrat  	Yes	Yes	Yes	Yes	Yes
Morph	Gabriel  	Sample	Sample	Sample	Sample	Sample
Revive 1	Kvadrat    ↓	Yes	Yes	Yes	Yes	Yes
Steelcut 2	Kvadrat  	Yes	Yes	Yes	Yes	Yes
Steelcut Trio 3	Kvadrat  	Yes	Yes	Yes	Yes	Yes
Band 6						
Hallingdal 65	Kvadrat  	Yes	Yes	Yes	Yes	Yes
Band 7						
Luna 2	Gabriel  	Yes	Yes	Yes	Yes	No
Revolution	Camira	Yes	Yes	Yes	Yes	Yes
Vintage L	Camira	Yes	Harc Tub only	Yes	No	Yes
Divina 3	Kvadrat   	Yes	Yes	Yes	Yes	Yes
Band 8						
Black leather		Yes	Yes	Yes	Yes	Yes
Band 10						
Leather, coloured		Yes	Yes	Yes	Yes	Yes

	People Certification	Certified for low VOC i.e. Oeko-tex, Greenguard Gold, Indoor Air Quality etc.
	Planet Certification	Certified for low environmental impact i.e. Ecolabel, Cradle-to-cradle etc.
	Recycled materials	Using either post-industrial or post-consumer recycled fibres. Using less energy and resources whilst resolving a potential waste issue.
	100% Natural material	Natural fibres like wool and hemp are naturally fire retardant and therefore may not need added FR chemicals (depending on requirements).
	Less resource intensive	Materials that use less water, energy or chemicals within production.

§ 1 Conclusion of Agreement

These general Terms of Sale and Delivery apply unless specifically derogated from by other written agreement.

§ 2 Prices and Payment – Retention of Title

All sales are made at prices in SEK applicable at the date of delivery. All prices are excl. VAT, public dues of any nature, packaging etc., unless otherwise specifically agreed and confirmed in writing by Vendor. Price stipulations in price charts are without obligation and may at any time be changed without prior notice. Current prices are listed in the newest updated price list. For goods not yet delivered, Vendor is entitled to increase the price equivalent to any price increase made by Vendor's subcontractors.

Payment is made cash with 30% before the production is started and the remaining 70% no later than 14 days before delivery, unless otherwise specifically agreed and confirmed in writing by Vendor.

Credit can be agreed if the Vendor can obtain satisfactory credit insurance from the Buyer. If the Vendor's insurance company revokes the credit insurance, the Vendor has the right to demand full payment immediately and without further notice.

On late payment default interest is charged with addition of interest at a rate of 2% per month started. If payment is not made on time the Vendor is entitled immediately and without further notice to cancel the sale.

The property right of the goods sold remains with Vendor in all respects until Buyer effectively has paid the purchase price and all other costs attached to the purchase.

§ 3 Time and Place of Delivery of Vendor's Goods

Times of delivery are approximate and not binding, unless otherwise specifically agreed and confirmed in writing by Vendor. Vendor cannot be held accountable for any costs due to delay.

All deliveries to the countries below* are made 'CIP' (INCOTERMS 2020) to the Buyer's place of business or warehouse within normal working hours and via truck without a lift. However, only for bridged islands. Deliveries to all other countries and non-bridged islands are made 'EX WORKS' (INCOTERMS 2020).

Deliveries with a total order value of less than SEK 11.000 incur a shipping fee of SEK 1.600. Orders that only contain spare parts are exempt from shipping fees.

The risk of the goods purchased passes to Buyer on delivery. In cases where Buyer is committed to collect the goods and Vendor keeps them ready, the risk passes to Buyer already at that time.

For deliveries that deviate from the above, a shipping fee is calculated. This includes e.g. delivery directly to the end customer, delivery by lift, delivery by small truck, etc., as well as if there are special requirements for the time of delivery, e.g. delivery on a specific day of the week or within a specific period of the day.

Contact (name, e-mail address and telephone number) and opening hours for receiving goods as well as any special requirements for trucks and delivery equipment.

In the event of unsuccessful delivery due to missing or incorrect information from Buyer, the Vendor reserves the right to invoice the additional costs incurred.

*The following countries are covered: Denmark, Norway (with zip code lower than 7995), Sweden, Finland, Germany, Benelux, France, Switzerland, Austria, Poland, Estonia, Latvia, and Lithuania.

§ 4 Delays by Vendor

If the Vendor becomes aware that he will be unable to meet the stipulated time of delivery, or that a delay on his part is likely to occur, he shall without undue delay notify the Buyer in writing stating the cause of the delay, and wherever possible, the time when delivery is likely to be made. Where a delay in delivery is due to any of the circumstances set forth in article 10 hereof (force majeure) or to acts or omissions on the part of the Buyer, the time of delivery shall be postponed for a period corresponding to the period in which the Vendor has been unable to deliver due to Buyer's conditions or conditions covered by article 10. This provision shall apply whether the cause of delay occurs before or after the end of the stipulated time of delivery. The Buyer shall not be entitled to cancel the agreement owing to delays in delivery attributable to the Vendor except where such delay exceeds three months.

The Buyer shall not be able to claim compensation owing to delays on the part of Vendor.

§ 5 Delays by Buyer

If the Buyer becomes aware that he will not be able to take delivery of/collect the goods by the stipulated date – or if a delay on his part is likely to occur – he shall forthwith notify the Vendor in writing, stating the cause of delay and, wherever possible, the time when taking delivery/collection of the goods shall be possible. In such cases the Buyer shall pay the purchase price and all other costs to the Vendor as if delivery of the relevant goods had taken place.

Should the Vendor not be able to deliver owing to conditions on the part of the Buyer, the Vendor shall make sure that the goods are properly stored for the Buyer's account and at the Buyer's risk. The Vendor shall at the Buyer's request insure the goods for the Buyer's account. The Vendor shall have the right to call upon the Buyer in writing to take delivery of the goods within a time limit of 15 days. Where the Buyer fails to do so within the same time limit for reasons that are not attributable to the Vendor, the Vendor shall be entitled to cancel the agreement by written notice to the Buyer. In such case, the Vendor shall have the right to demand compensation for any loss he has incurred from the Buyer's non-performance.

If the Buyer unjustifiably allows remediation to be carried out by a third party, the Buyer cannot demand his costs covered by the Vendor.

§ 6 Nonconformity

If it becomes apparent that the goods do not conform with the agreement, Vendor has the option to effect repairs or otherwise to redress. The Vendor is under no circumstances responsible for operating-, time-, profit-, or other indirect losses of the Buyer or the Buyer's customers or other users of the delivery. The Buyer cannot claim compensation to cover the costs that may be incurred during removal or reassembly.

Only if within a reasonable time and on a reasonable number of repair attempts Vendor is not able to correct or make good the defect etc., Buyer may arrange for repair by third party or claim a reduction in the purchase

price. If Buyer unjustly arranges for third party to repair, Buyer may not in such cases claim cover of his costs in respect thereof from Vendor.

In cases of short deliveries (quantitative lack of conformity) Vendor may make subsequent deliveries within a reasonable time, in which case Buyer may not invoke breach.

The Buyer shall notify the Vendor in writing of any defects without undue delay after such defects have appeared. Minor knots, differences in shades as well as strong and weak annual rings are signs of genuineness and are not considered to be defects.

Damage to products must be noted on the waybill for goods to be replaced. "Goods received with reservations" is not sufficient. Buyer carries the full risk that Vendor's goods are suited for purposes particularly applicable for Buyer.

If the Buyer has not notified the Vendor within two years from the date of delivery, the Buyer is prevented from making claims in respect of defects, compensation, any warranty claims, or other remedies.

§ 7 Warranties

Vendor always uses first class materials, and our products continuously undergo strict quality control.

Information about testing and standards can be found on our website under the individual products: www.fourdesign.dk

5-year warranty

Vendor provides an extended warranty of 5 years on chairs and tables in our official price list. The warranty covers breakage of frames and damage occurred because of deficient craftsmanship performance under normal use.

The warranty shall lapse if the product shows signs of mishandling abuse or other physical damage. The warranty does not cover those parts of the product which are exposed to abrasion during use.

Spare parts

Spare parts for the furniture product will be available for a period of 5 years from the date of purchase of the product.

The parts will be available without charge during the guarantee period if the goods are found to be faulty during normal use.

A proportionate cost will be charged if the goods were damaged by misuse.

Surfaces

Vendor recommends the use of chrome on stacking chairs and foldable tables. There is no warranty for damage to other surfaces such as Satin chrome and powder coating.

Vendor do not recommend black lacquered veneer on seats or powder painted steel where the chair suspension system is being used.

When stacking upholstered chairs, you may get pressure marks on the fabric. These are temporary and will disappear once the chairs are unstacked.

We rely on the fabric supplier's guarantee, as far as wear, peeling, etc.

§ 8 Limitation of Liability

Vendor is only liable for defects in Vendor's goods if Buyer has used the goods as prescribed and in a sound manner, and according to Vendor's directions, if any. Vendor's liability is limited to defects in Vendor's own goods and not to defects or faults that arise in connection with Vendors.

goods being incorporated in or to those of others. In no circumstances is Vendor liable for any loss on operations, time, profit margin or other indirect losses suffered by Buyer or Buyer's customers or other users of Vendor's goods. Buyer may not claim compensation to cover the costs incidental to dismounting and remounting the objects or installations, in which the goods might be incorporated.

To the extent that Vendor is held liable towards third parties, Buyer must hold Vendor harmless to the extent such liability exceeds the limits set out in these terms. In no event may Vendor's liability for the goods supplied exceed the total price hereof.

§ 9 Product Liability

In the mutual relations between Vendor and Buyer, Vendor excludes any liability for commercial property damage that may be attached to Vendor's goods. If Vendor is met with claims for damages for commercial property damage from Buyer's customers, their customers or other later users of Vendor's goods, Buyer in the relations between Vendor and Buyer is committed to indemnify Vendor for any such claim and to cover Vendor's reasonable costs to any defence against that.

§ 10 Force majeure

The following circumstances shall give rise to exemption from liability if they prevent the performance of the agreement or render such performance unreasonably onerous: Labour conflicts and any other circumstance beyond the control of the Vendor, such as but not limited to fire, war, mobilisation or unforeseen military callups of a corresponding scale, requisitioning, seizure, foreign exchange restrictions, insurrection and civil unrest, lack of transportation, general scarcity of goods, and defects in or delays of deliveries from sub suppliers due to any of the factors set forth in this paragraph.

Circumstances of the type mentioned above, which had occurred prior to the conclusion of this agreement, shall exempt the Vendor from liability only where their influence on the performance of the agreement could not be foreseen by the Vendor at the time when the agreement was entered into. Where the Vendor intends to invoke any exemption from liability grounds set forth in this article, he shall without undue delay notify the Buyer in writing of such grounds.

Notwithstanding any stipulation in these conditions of sale and terms of delivery, either of the parties may cancel the agreement by written notice to the other party where the performance of the agreement is prevented for more than six months by one of the events set forth in this article.

§ 11 In general

Any disputes arising out of or in connection with agreements between Vendor and Buyer are to be settled pursuant to Danish law.

Vendor reserves the right for printing errors. Vendor's liability for the goods supplied exceed the total price hereof.

Last update: January 2024



You are Always Welcome in our Showrooms

Aarhus
+45 4016 6565
Balticagade 15
DK-8000 Aarhus C
Denmark

Copenhagen
+45 2030 7122
Carl Jacobsensvej 16
DK-2500 Valby
Denmark

Odense
+45 6229 1132
Lucernemarken 17-19
DK-5260 Odense S.
Denmark

Oslo
+47 9953 0223
Drammensveien 130
0277 Oslo
Norway

Düsseldorf
+49 1722 8042 42
Düsseldorfer Str 16
DE-40699 Erkrath
Germany

London
20 Old Street
Clerkenwell
London, EC1V 9AB
United Kingdom

Northampton
Caswell Road
Brackmills Industrial Est.
Northampton, NN4 7PW
United Kingdom

Ocee & Four Design products are available worldwide

North America
hightoweraccess.com

Hightower

Oceania
fusefurniture.com.au



China
Novah.cn





We turn good
spaces into great
experiences

OCEEFOUR.COM