

SWEDISH

# Price List

2024



**ocee & four**  
DESIGN



# Hello, we are Ocee & Four Design!

We are on a mission to turn every good space into a great experience. Experience is about connecting with people, and that is why our furniture is designed with people in mind: How do they connect with others? What inspires and engages them? Where do they feel most comfortable? Who do they spend their time with? Why do they work in the way they do? These questions form the basis of the creative, comfortable, and productive spaces we work with our partners to create.

Our furniture solutions and products are highly curated to suit a variety of needs and spaces. We believe nothing beats family, and our products reflect that. You will find solutions that work together in perfect harmony to create beautiful spaces, while also maintaining their individual characteristics as standalone designs.

Ingenious design, unrivalled functionality, a focus on people, and a healthy dose of wonder – this is how we turn good spaces into great experiences.

# FourSure® Family ↗

---



EU Ecolabel  
FourSure®



FourSure® 44



FourSure® 88



FourSure® 90/105



FourSure® 66



FourSure® 77



FourSure® 11



FourSure® 99

# FourCast® 2 Family ↗

---



EU Ecolabel  
FourCast® 2



FourCast® 2 Four



FourCast® 2 Line



FourCast® 2 Counter /  
High



FourCast® 2 Counter  
Four / High Four



FourCast® 2 Wheeler



FourCast® 2 77



FourCast® 2 One



FourCast® 2 Fire  
Retardant



## FourMe® Family ↗

---



FourMe® 44



FourMe® 88



FourMe® 66

## Share Family ↗

---



Share Basic



Share Stool



Share Bench

## Upholstered Stools ↗

---



Casino

# FourReal® Table Family ↗

---



FourReal® 74



FourReal® 741 Flake



FourReal® Flex



FourReal® 90



FourReal® 105



FourReal® A 74 /  
A XL 74



FourReal® A Flex



FourReal® A 90 /  
A XL 90



FourFold®



Acoustic Panels



Tray



Power Cube

# Four® Tables ↗

---



Four® Learning



Four® Eating



Four® Meeting



Four® Standing  
90 / 103



Four® Resting  
H 51 / 64 / 72,5 / 103



Y-Table

## Soft seating ↗

---



FourPeople®  
Family



FourLikes®  
Family



FourUs®  
Family



Harc  
Family

## Acoustic ↗

---



InnoPod®

## Links

---

[Sustainability ↗](#)

[Certificates ↗](#)

[Electrical accessories ↗](#)

[Accessories ↗](#)

[Colour codes ↗](#)

[Fabric bands ↗](#)

[Terms & Conditions ↗](#)

[Contact ↗](#)

## Environmental Symbols

---



Eco-labelled product



Sustainability-marked product or component



Climate calculated product



Product that contains recycled or renewable material



Disassembled product



## FEATURES



- The chair consists of 50 % recycled plastic
- Limitation of substances that are harmful to health and the environment
- Linking device optional on frames or under seat
- Matches table height 74 cm, 90 cm & 105 cm
- Polyamide glides as standard
- Stackable on matching trolley

For product information visit [oceefour.com](http://oceefour.com) ↗

## SHELL COLOURS

Standard Polypropylene



## FRAME COLOURS

Standard







For full colour details [go to page 250](#) ↗

Product	Description (Item nr)	Weight (Kg)	Stacking on floor	Dimensions (mm)	Band	Standard PP (SEK)
	<b>22500</b> FourSure® 44, Polypropylene shell	5	-		-	2.020
	<b>23200</b> FourSure® 88, Polypropylene shell	6	-		-	2.479
	<b>23800</b> FourSure® 90, Polypropylene shell	6.9	-		-	3.409
	<b>23900</b> FourSure® 105, Polypropylene shell	7.7	-		-	3.492

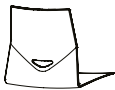

Design by Strand+Hvass

ACCESSORIES	Description	Weight (Kg)	Dimensions (mm)	Price (SEK)
	<b>CHAIR FEET</b> Felt glides, set of 4 pcs. height + 0,2 cm	1,82 g x 4		208
	<b>CHAIR FEET</b> Teflon glides, set of 4 pcs. Chair height + 0,2 cm	2,75 g x 4		208
	<b>LINKING DEVICE</b> Chair linking	0,4 KG	C/C 535 mm C/C with armrest 585 mm C/C with Loop armrest 625 mm	417
	<b>LINKING DEVICE</b> Chair linking		C/C 540 mm C/C with armrest 540 mm	390
	<b>GRIP HOLE</b> Available for chairs without inside – and full upholstery			189
	<b>SEAT ROW NUMBER - ACSR0201</b> 11 mm - no. 1 -25	29 g		1.579
	<b>SEAT ROW NUMBER - ACSR0202</b> 11 mm - no. 26 -50	29 g		1.579
	<b>SEAT ROW NUMBER - ACSR0101</b> 16 mm - no. 1 -25	29 g		1.579
	<b>SEAT ROW NUMBER - ACSR0102</b> 16 mm - no. 26 -50	29 g		1.579
	<b>CHAIR TROLLEY - 200X0</b> 28 chairs without upholstery	33,5 Kg	1100 x 560 x 1970 mm	8.859



## FEATURES

- Armrest options and wooden legs options\*
- Linking device under seat options
- Monochrome powder coating on frames options
- Polyamide glides as standard
- Inno® Note tablet options
- Stackable on matching trolley
- Outdoor options
- We do not recommend suspensions for fully upholstered version



For product information visit [oceefour.com](http://oceefour.com) ↗

## SHELL COLOURS

Standard Polypropylene



## FRAME COLOURS

Standard





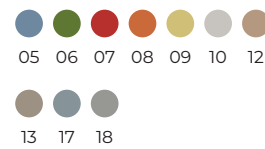



Optional Polypropylene



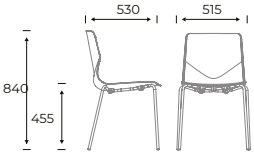

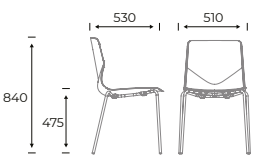

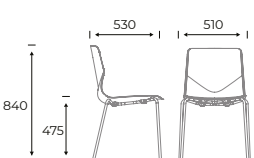

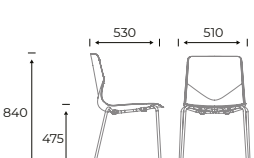
Frame optional\*



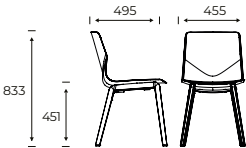

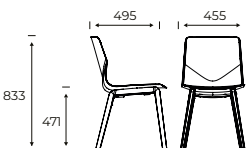

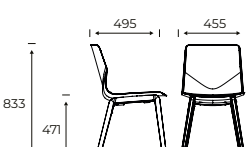

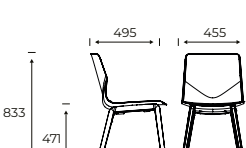

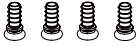

For full colour details [go to page 250](#) ↗

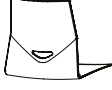
Product	Description (Item nr)	Weight (Kg)	Stacking on floor	Dimensions (mm)	Band	Standard PP (SEK)	Optional PP (SEK)
	<b>22500</b> FourSure® 44, Polypropylene shell	5	12		-	2.020	2.211
	<b>22510</b> FourSure® 44, Seat pad	5.9	10		1 2 3 4 5 6 7 8 10	3.282 3.377 3.472 3.566 3.658 3.754 3.849 3.943 4.161	3.473 3.568 3.663 3.757 3.849 3.945 4.040 4.134 4.352
	<b>22520</b> FourSure® 44, Inside upholstery	6.3	8		1 2 3 4 5 6 7 8 10	4.438 4.629 4.821 5.010 5.202 5.393 5.584 5.774 6.158	4.629 4.820 5.012 5.201 5.393 5.584 5.775 5.965 6.349
	<b>22530</b> FourSure® 44, Fully upholstered	5.7	6		1 2 3 4 5 6 7 8 10	4.719 4.940 5.161 5.382 5.601 5.824 6.044 6.265 6.748	

Product	Description (Item nr)	Weight (Kg)	Stacking on floor	Dimensions (mm)	Band	Standard PP (SEK)	Optional PP (SEK)
	<b>22600</b> FourSure® 44 with Armrests, Polypropylene shell	5.6	12		-	3.174	3.365
	<b>22610</b> FourSure® 44 with Armrests, Seat pad	6.4	10		1 2 3 4 5 6 7 8 10	4.436 4.531 4.626 4.720 4.812 4.908 5.003 5.097 5.315	4.627 4.722 4.817 4.911 5.003 5.099 5.194 5.288 5.506
	<b>22620</b> FourSure® 44 with Armrests, Inside upholstery	6.8	8		1 2 3 4 5 6 7 8 10	5.592 5.783 5.975 6.164 6.356 6.547 6.738 6.928 7.312	5.783 5.974 6.166 6.355 6.547 6.738 6.929 7.119 7.503
	<b>22630</b> FourSure® 44 with Armrests, Fully upholstered	6.2	6		1 2 3 4 5 6 7 8 10	5.873 6.094 6.315 6.536 6.755 6.978 7.198 7.419 7.902	
	<b>22700</b> FourSure® 44 with Loop Armrests, Polypropylene shell	6.1	12		-	3.174	3.365
	<b>22710</b> FourSure® 44 with Loop Armrests, Seat pad	6.9	10		1 2 3 4 5 6 7 8 10	4.436 4.531 4.626 4.720 4.812 4.908 5.003 5.097 5.315	4.627 4.722 4.817 4.911 5.003 5.099 5.194 5.288 5.506
	<b>22720</b> FourSure® 44 with Loop Armrests, Inside upholstery	7.3	8		1 2 3 4 5 6 7 8 10	5.592 5.783 5.975 6.164 6.356 6.547 6.738 6.928 7.312	5.783 5.974 6.166 6.355 6.547 6.738 6.929 7.119 7.503
	<b>22730</b> FourSure® 44 with Loop Armrests, Fully upholstered	6.8	6		1 2 3 4 5 6 7 8 10	5.873 6.094 6.315 6.536 6.755 6.978 7.198 7.419 7.902	

Product	Description (Item nr)	Weight (Kg)	Stacking on floor	Dimensions (mm)	Band	Standard PP (SEK)	Optional PP (SEK)
	<b>22500</b> FourSure® 44, Polypropylene shell, Oak lacquered	5	-		-	3.748	3.939
	<b>22510</b> FourSure® 44, Seat pad, Oak lacquered	5.9	-		1 2 3 4 5 6 7 8 10	5.010 5.105 5.200 5.294 5.386 5.482 5.577 5.671 5.889	5.201 5.296 5.391 5.485 5.577 5.673 5.768 5.862 6.080
	<b>22520</b> FourSure® 44, Inside upholstery, Oak lacquered	6.3	-		1 2 3 4 5 6 7 8 10	6.166 6.357 6.549 6.738 6.930 7.121 7.312 7.502 7.886	6.357 6.548 6.740 6.929 7.121 7.312 7.503 7.693 8.077
	<b>22530</b> FourSure® 44, Fully upholstered, Oak lacquered	5.7	-		1 2 3 4 5 6 7 8 10	6.447 6.668 6.889 7.110 7.329 7.552 7.772 7.993 8.476	





ACCESSORIES	Description	Weight (Kg)	Dimensions (mm)	Price (SEK)
	<b>CHAIR FEET</b> Felt glides, set of 4 pcs. height + 0,2 cm	1,82 g x 4		208
	<b>CHAIR FEET</b> Set of 4 pcs. Noise reducing ferrule with big diameter (reduces pressure marks ) Chair height + 0,8 cm	4,8 g x 4		276
	<b>CHAIR FEET</b> Noise reducing ferrule with felt, set of 4 pcs. Chair height + 1 cm	6,6 g x 4		276
	<b>CHAIR FEET</b> Teflon glides, set of 4 pcs. Chair height + 0,2 cm	2,75 g x 4		208
	<b>LINKING DEVICE</b> Chair linking	0,4 KG	C/C 535 mm C/C with armrest 585 mm C/C with Loop armrest 625 mm	417
	<b>GRIP HOLE</b> Available for chairs without inside – and full upholstery			189
	<b>INNO</b> Inno® Note in black, removable and foldable. Not available for chairs with Loop armrest and chairs with wooden legs.	1,4 KG	225 x 325 x 10 mm	1.522
	<b>SEAT ROW NUMBER - ACSR0101</b> 16 mm - no. 1 -25	29 g		1.579
	<b>SEAT ROW NUMBER - ACSR0102</b> 16 mm - no. 26 -50	29 g		1.579
	<b>INNO@NOTE TROLLEY - 20100007</b> Trolley for Inno® Note. Room for 51 Inno® Notes.	58,5 Kg	1532 x 662 x 1199 mm	19.942
	<b>CHAIR TROLLEY - 200X0</b> 28 chairs without upholstery	33,5 Kg	1100 x 560 x 1970 mm	8.859
	<b>CHAIR TROLLEY - 200X0</b> 20 chairs with seat pad / inside upholstery or 18 chairs with full upholstery	33,5 Kg	1100 x 560 x 1910 / 1980 mm	10.373
	<b>SACK TROLLEY - 200X1</b> 12 chairs without upholstery, 10 chairs with seat pad / inside upholstery or 6 chairs with full upholstery			4.918

# FourSure® 44

Design by Strand+Hvass

[Content ↗](#)

SURCHARGE		Price (SEK)
<b>FRAME OPTIONAL</b>	 7 A D E F M N O Q S T	194
	 V	476



## FEATURES

- Armrest options
- Linking device optional on frames or under seat
- Monochrome powder coating on frames options
- Polyamide glides as standard
- Inno® Note tablet options
- Stackable on matching trolley
- Outdoor options
- We do not recommend suspensions for fully upholstered version

For product information visit [oceefour.com](http://oceefour.com) ↗

## SHELL COLOURS

Standard Polypropylene



## FRAME COLOURS

Standard

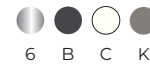



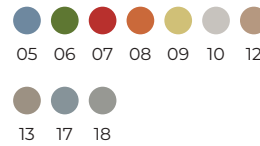



Optional Polypropylene



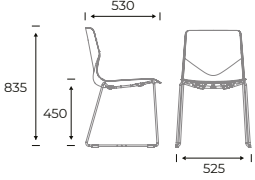

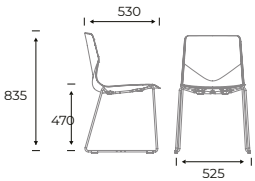

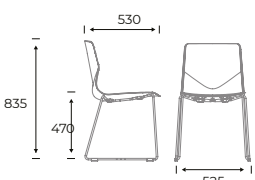

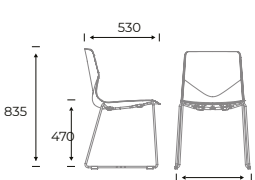
Frame optional\*

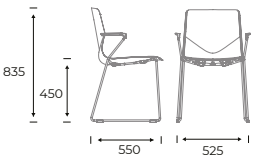

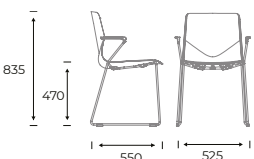

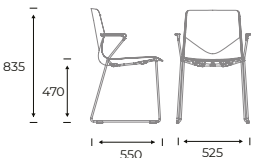

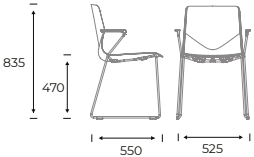



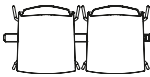

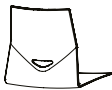
For full colour details [go to page 250](#) ↗

Product	Description (Item nr)	Weight (Kg)	Stacking on floor	Dimensions (mm)	Band	Standard PP (SEK)	Optional PP (SEK)
	<b>23200</b> FourSure® 88, Polypropylene shell	6	12		-	2.479	2.670
	<b>23210</b> FourSure® 88, Seat pad	6.8	10		1 2 3 4 5 6 7 8 10	3.741 3.836 3.931 4.025 4.117 4.213 4.308 4.402 4.620	3.932 4.027 4.122 4.216 4.308 4.404 4.499 4.593 4.811
	<b>23220</b> FourSure® 88, Inside upholstery	7.2	10		1 2 3 4 5 6 7 8 10	4.897 5.088 5.280 5.469 5.661 5.852 6.043 6.233 6.617	5.088 5.279 5.471 5.660 5.852 6.043 6.234 6.424 6.808
	<b>23230</b> FourSure® 88, Fully upholstered	6.6	8		1 2 3 4 5 6 7 8 10	5.178 5.399 5.620 5.841 6.060 6.283 6.503 6.724 7.207	

Product	Description (Item nr)	Weight (Kg)	Stacking on floor	Dimensions (mm)	Band	Standard PP (SEK)	Optional PP (SEK)
	<b>23300</b> FourSure® 88 with Armrests, Polypropylene shell	6.7	12		-	3.609	3.800
	<b>23310</b> FourSure® 88 with Armrests, Seat pad	7.5	10		1 2 3 4 5 6 7 8 10	4.871 4.966 5.061 5.155 5.247 5.343 5.438 5.532 5.750	5.062 5.157 5.252 5.346 5.438 5.534 5.629 5.723 5.941
	<b>23320</b> FourSure® 88 with Armrests, Inside upholstery	7.9	10		1 2 3 4 5 6 7 8 10	6.027 6.218 6.410 6.599 6.791 6.982 7.173 7.363 7.747	6.218 6.409 6.601 6.790 6.982 7.173 7.364 7.554 7.938
	<b>23330</b> FourSure® 88 with Armrests, Fully upholstered	7.4	8		1 2 3 4 5 6 7 8 10	6.308 6.529 6.750 6.971 7.190 7.413 7.633 7.854 8.337	



ACCESSORIES	Description	Weight (Kg)	Dimensions (mm)	Price (SEK)
	<b>CHAIR FEET</b> Felt glides, set of 4 pcs. height + 0,2 cm	1,82 g x 4		208
	<b>CHAIR FEET</b> Teflon glides, set of 4 pcs. Chair height + 0,2 cm	2,75 g x 4		208
	<b>LINKING DEVICE</b> Chair linking	0,4 KG	C/C 535 mm C/C with armrest 585 mm C/C with Loop armrest 625 mm	417
	<b>LINKING DEVICE</b> Chair linking		C/C 540 mm C/C with armrest 540 mm	390
	<b>GRIP HOLE</b> Available for chairs without inside – and full upholstery			189
	<b>INNO</b> Inno® Note in black, removable and foldable. Not available for chairs with Loop armrest and chairs with wooden legs.	1,4 KG	225 x 325 x 10 mm	1.522
	<b>SEAT ROW NUMBER - ACSR0201</b> 11 mm - no. 1 -25	29 g		1.579
	<b>SEAT ROW NUMBER - ACSR0202</b> 11 mm - no. 26 -50	29 g		1.579
	<b>INNO@NOTE TROLLEY - 20100007</b> Trolley for Inno® Note. Room for 51 Inno® Notes.	58,5 Kg	1532 x 662 x 1199 mm	19.942
	<b>CHAIR TROLLEY - 200X0</b> 35 chairs without upholstery	33,5 Kg	1100 x 560 x 1970 mm	8.859
	<b>CHAIR TROLLEY - 200X0</b> 20 chairs with seat pad / inside upholstery or 18 chairs with full upholstery	33,5 Kg	1100 x 560 x 1910 / 1980 mm	10.373
	<b>SACK TROLLEY - 200X1</b> 12 chairs without upholstery, 10 with seat pad / inside upholstery or 8 chairs with full upholstery			4.918
SURCHARGE				Price (SEK)
<b>FRAME OPTIONAL</b>	 7 A D E F M N O Q S T			194



## FEATURES

- Fits table height 90 cm
- Stackable on floor
- Polyamide glides as standard
- Monochrome powder coating on frames options
- Outdoor options
- We do not recommend suspensions to fully upholstered version



For product information visit [oceefour.com](http://oceefour.com) ↗

## SHELL COLOURS

Standard Polypropylene



## FRAME COLOURS

Standard



Optional Polypropylene

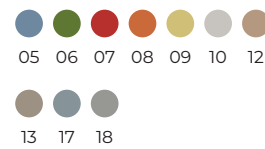







Frame optional\*

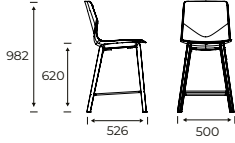

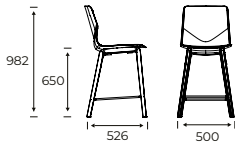
For full colour details [go to page 250](#) ↗

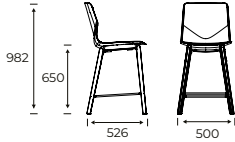
Product	Description (Item nr)	Weight (Kg)	Stacking on floor	Dimensions (mm)	Band	Standard PP (SEK)	Optional PP (SEK)
	<b>23800</b> FourSure® 90, Polypropylene shell	6.9	4		-	3.409	3.600
	<b>23810</b> FourSure® 90, Seat pad	7.8	4		1 2 3 4 5 6 7 8 10	4.671 4.766 4.861 4.955 5.047 5.143 5.238 5.332 5.550	4.862 4.957 5.052 5.146 5.238 5.334 5.429 5.523 5.741
	<b>23820</b> FourSure® 90, Inside upholstery	8.1	4		1 2 3 4 5 6 7 8 10	5.827 6.018 6.210 6.399 6.591 6.782 6.973 7.163 7.547	6.018 6.209 6.401 6.590 6.782 6.973 7.164 7.354 7.738
	<b>23830</b> FourSure® 90, Fully upholstered	7.6	4		1 2 3 4 5 6 7 8 10	6.108 6.329 6.550 6.771 6.990 7.213 7.433 7.654 8.137	

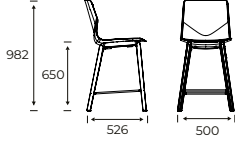
Product	Description (Item nr)	Weight (Kg)	Stacking on floor	Dimensions (mm)	Band	Standard PP (SEK)	Optional PP (SEK)
	<b>23800</b> FourSure® 90, Polypropylene shell, Oak lacquered	6.9	-		-	5.170	5.361
	<b>23810</b> FourSure® 90, Seat pad, Oak lacquered	7.8	-		1 2 3 4 5 6 7 8 10	6.432 6.527 6.622 6.716 6.808 6.904 6.999 7.093 7.311	6.623 6.718 6.813 6.907 6.999 7.095 7.190 7.284 7.502
	<b>23820</b> FourSure® 90, Inside upholstery, Oak lacquered	8.1	-		1 2 3 4 5 6 7 8 10	7.588 7.779 7.971 8.160 8.352 8.543 8.734 8.924 9.308	7.779 7.970 8.162 8.351 8.543 8.734 8.925 9.115 9.499
	<b>23830</b> FourSure® 90, Fully upholstered, Oak lacquered	7.6	-		1 2 3 4 5 6 7 8 10	7.869 8.090 8.311 8.532 8.751 8.974 9.194 9.415 9.898	

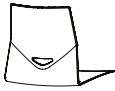
ACCESSORIES	Description	Weight (Kg)	Dimensions (mm)	Price (SEK)
	<b>CHAIR FEET</b> Felt glides, set of 4 pcs. height + 0,2 cm	1,82 g x 4		208
	<b>CHAIR FEET</b> Teflon glides, set of 4 pcs. Chair height + 0,2 cm	2,75 g x 4		208
	<b>GRIP HOLE</b> Available for chairs without inside – and full upholstery			189

SURCHARGE		Price (SEK)
<b>FRAME OPTIONAL</b>	 7 A D E F M N O Q S T  V	194 475



## FEATURES

- Fits table height 105 cm
- Stackable on floor
- Polyamide glides as standard
- Monochrome powder coating on frames options
- Outdoor options
- We do not recommend suspensions to fully upholstered version



For product information visit [oceefour.com](http://oceefour.com) ↗

## SHELL COLOURS

Standard Polypropylene



## FRAME COLOURS

Standard





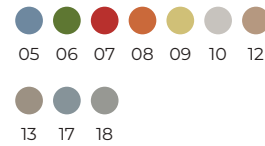



Optional Polypropylene



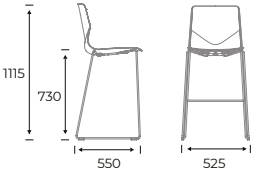

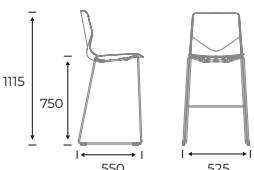

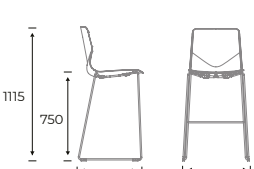

Frame optional\*



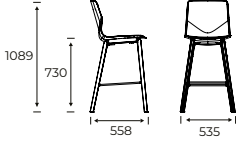

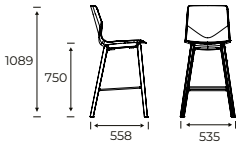
For full colour details [go to page 250](#) ↗

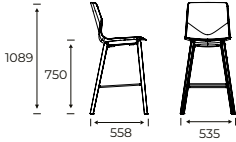
Product	Description (Item nr)	Weight (Kg)	Stacking on floor	Dimensions (mm)	Band	Standard PP (SEK)	Optional PP (SEK)
	<b>23900</b> FourSure® 105, Polypropylene shell	7.7	4		-	3.492	3.683
	<b>23910</b> FourSure® 105, Seat pad	8.5	4		1 2 3 4 5 6 7 8 10	4.754 4.849 4.944 5.038 5.130 5.226 5.321 5.415 5.633	4.945 5.040 5.135 5.229 5.321 5.417 5.512 5.606 5.824
	<b>23920</b> FourSure® 105, Inside upholstery	8.9	4		1 2 3 4 5 6 7 8 10	5.910 6.101 6.293 6.482 6.674 6.865 7.056 7.246 7.630	6.101 6.292 6.484 6.673 6.865 7.056 7.247 7.437 7.821
	<b>23930</b> FourSure® 105, Fully upholstered	8.4	4		1 2 3 4 5 6 7 8 10	6.191 6.412 6.633 6.854 7.073 7.296 7.516 7.737 8.220	

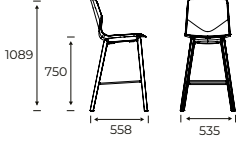

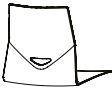
Product	Description (Item nr)	Weight (Kg)	Stacking on floor	Dimensions (mm)	Band	Standard PP (SEK)	Optional PP (SEK)
	<b>23900</b> FourSure® 105, Polypropylene shell, Oak lacquered	7.7	-		-	5.366	5.557
	<b>23910</b> FourSure® 105, Seat pad, Oak lacquered	8.5	-		1 2 3 4 5 6 7 8 10	6.628 6.723 6.818 6.912 7.004 7.100 7.195 7.289 7.507	6.819 6.914 7.009 7.103 7.195 7.291 7.386 7.480 7.698
	<b>23920</b> FourSure® 105, Inside upholstery, Oak lacquered	8.9	-		1 2 3 4 5 6 7 8 10	7.784 7.975 8.167 8.356 8.548 8.739 8.930 9.120 9.504	7.975 8.166 8.358 8.547 8.739 8.930 9.121 9.311 9.695
	<b>23930</b> FourSure® 105, Fully upholstered, Oak lacquered	8.4	-		1 2 3 4 5 6 7 8 10	8.065 8.286 8.507 8.728 8.947 9.170 9.390 9.611 10.094	

ACCESSORIES	Description	Weight (Kg)	Dimensions (mm)	Price (SEK)
	<b>CHAIR FEET</b> Felt glides, set of 4 pcs. height + 0,2 cm	1,82 g x 4		208
	<b>CHAIR FEET</b> Teflon glides, set of 4 pcs. Chair height + 0,2 cm	2,75 g x 4		208
	<b>GRIP HOLE</b> Available for chairs without inside – and full upholstery			189

SURCHARGE		Price (SEK)
<b>FRAME OPTIONAL</b>	 7 A D E F M N O Q S T  V	194 474



## FEATURES

- Inno® Tab, flexible and rotating writing tablet options
- Gas lift, 41 - 57,5 cm
- Free Float options
- Black base with castors as standard
- Aluminium base options
- We do not recommend suspensions to fully upholstered version



For product information visit [oceefour.com](http://oceefour.com) ↗

## SHELL COLOURS

Standard Polypropylene



## FRAME COLOURS

Standard



Optional Polypropylene

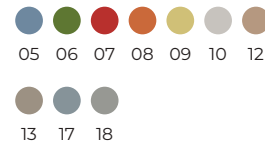









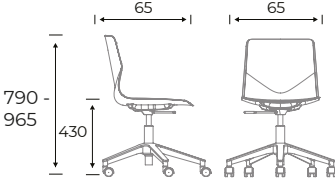

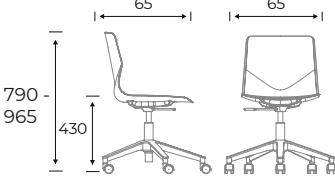

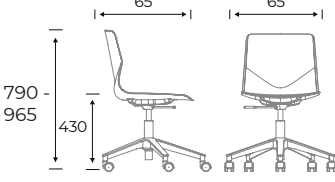

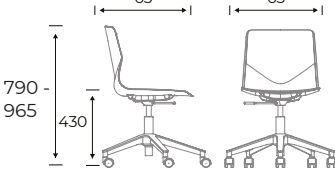





Frame optional\*



For full colour details [go to page 250](#) ↗

Product	Description (Item nr)	Weight (Kg)	Dimensions (mm)	Band	Standard PP (SEK)	Optional PP (SEK)
	<b>25004</b> FourSure® 66, Polypropylene shell, Without tilt with gas	7.4		-	2.783	2.974
	<b>25005</b> FourSure® 66, Polypropylene shell, With tilt with gas	7.5		-	3.147	3.338
	<b>25014</b> FourSure® 66, Seat pad, Without tilt with gas	8		1 2 3 4 5 6 7 8 10	4.045 4.140 4.235 4.329 4.421 4.517 4.612 4.706 4.924	4.236 4.331 4.426 4.520 4.612 4.708 4.803 4.897 5.115
	<b>25015</b> FourSure® 66, Seat pad, With tilt with gas	8		1 2 3 4 5 6 7 8 10	4.409 4.504 4.599 4.693 4.785 4.881 4.976 5.070 5.288	4.600 4.695 4.790 4.884 4.976 5.072 5.167 5.261 5.479

Product	Description (Item nr)	Weight (Kg)	Dimensions (mm)	Band	Standard PP (SEK)	Optional PP (SEK)
	<b>25024</b> FourSure® 66, Inside upholstery, Without tilt with gas	8.4		1 2 3 4 5 6 7 8 10	5.201 5.392 5.584 5.773 5.965 6.156 6.347 6.537 6.921	5.392 5.583 5.775 5.964 6.156 6.347 6.538 6.728 7.112
	<b>25025</b> FourSure® 66, Inside upholstery, With tilt with gas	8.4		1 2 3 4 5 6 7 8 10	5.565 5.756 5.948 6.137 6.329 6.520 6.711 6.901 7.285	5.756 5.947 6.139 6.328 6.520 6.711 7.092 7.476
	<b>25034</b> FourSure® 66, Fully upholstered, Without tilt with gas	7.8		1 2 3 4 5 6 7 8 10	5.482 5.703 5.924 6.145 6.364 6.587 6.807 7.028 7.511	
	<b>25035</b> FourSure® 66, Fully upholstered, With tilt with gas	13.7		1 2 3 4 5 6 7 8 10	5.846 6.067 6.288 6.509 6.728 6.951 7.171 7.392 7.875	
	<b>24905</b> FourSure® 66 with Loop Armrests, Polypropylene shell, With tilt with gas	8.7		-	4.291	4.482
	<b>24915</b> FourSure® 66 with Loop Armrests, Seat pad, With tilt with gas	9.4		1 2 3 4 5 6 7 8 10	5.553 5.648 5.743 5.837 5.929 6.025 6.120 6.214 6.432	5.744 5.839 5.934 6.028 6.120 6.216 6.311 6.405 6.623
	<b>24925</b> FourSure® 66 with Loop Armrests, Inside upholstery, With tilt with gas	9.7		1 2 3 4 5 6 7 8 10	6.709 6.900 7.092 7.281 7.473 7.664 7.855 8.045 8.429	6.900 7.091 7.283 7.472 7.664 7.855 8.046 8.236 8.620
	<b>24935</b> FourSure® 66 with Loop Armrests, Fully upholstered, With tilt with gas	9.2		1 2 3 4 5 6 7 8 10	6.990 7.211 7.432 7.653 7.872 8.095 8.315 8.536 9.019	

ACCESSORIES	Description	Weight (Kg)	Dimensions (mm)	Price (SEK)
	<b>HOOK</b> Hook in black			47
	<b>CHAIR FEET</b> Standard polymide glides. Chair height + 0,2 cm			
	<b>CHAIR FEET</b> Castor with breaks, hard			599
	<b>FOOTRING</b> Gas lift including footring Spand 41 cm. - 57,5 cm.		585 - 845 mm	1.368
	With GS certification			1.489
	<b>INNO</b> Foldable Inno® Tab in black with integrated cup holder and dashboard for tablet and phone.	2,7 KG	520 x 320 x 23 mm	2.125
SURCHARGE				Price (SEK)
<b>FRAME OPTIONAL</b>	 4			643



## FEATURES

- Armrest options
- Stackable on floor
- Monochrome powder coating on frames options
- We do not recommend suspensions for fully upholstered version

For product information visit [oceefour.com](http://oceefour.com) ↗

## SHELL COLOURS

Standard Polypropylene



Optional Polypropylene

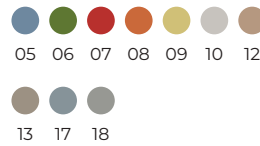

## FRAME COLOURS

Standard

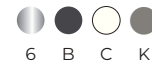

Frame optional\*









For full colour details [go to page 250](#) ↗

Product	Description (Item nr)	Weight (Kg)	Stacking on floor	Dimensions (mm)	Band	Standard PP (SEK)	Optional PP (SEK)
	<b>22800</b> FourSure® 77, Polypropylene shell	6	7		-	2.464	2.655
	<b>22810</b> FourSure® 77, Seat pad	6.9	5		1 2 3 4 5 6 7 8 10	3.726 3.821 3.916 4.010 4.102 4.198 4.293 4.387 4.605	3.917 4.012 4.107 4.201 4.293 4.389 4.484 4.578 4.796
	<b>22820</b> FourSure® 77, Inside upholstery	7.3	5		1 2 3 4 5 6 7 8 10	4.882 5.073 5.265 5.454 5.646 5.837 6.028 6.218 6.602	5.073 5.264 5.456 5.645 5.837 6.028 6.219 6.409 6.793
	<b>22830</b> FourSure® 77, Fully upholstered	6.8	5		1 2 3 4 5 6 7 8 10	5.163 5.384 5.605 5.826 6.045 6.268 6.488 6.709 7.192	

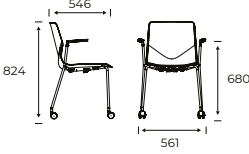
# FourSure® 77

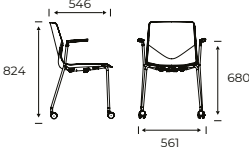
Design by Strand+Hvass

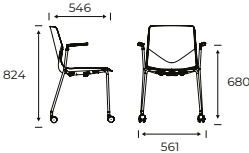
[Content ↗](#)

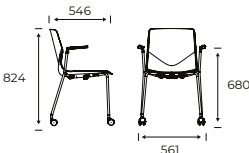
Product	Description (Item nr)	Weight (Kg)	Stacking on floor	Dimensions (mm)	Band	Standard PP (SEK)	Optional PP (SEK)
	<b>22900</b> FourSure® 77 with Armrests, Polypropylene shell	7.5	-		-	3.618	3.809
	<b>22910</b> FourSure® 77 with Armrests, Seat pad	8	-		1 2 3 4 5 6 7 8 10	4.880 4.975 5.070 5.164 5.256 5.352 5.447 5.541 5.759	5.071 5.166 5.261 5.355 5.447 5.543 5.638 5.732 5.950
	<b>22920</b> FourSure® 77 with Armrests, Inside upholstery	8.4	-		1 2 3 4 5 6 7 8 10	6.036 6.227 6.419 6.608 6.800 6.991 7.182 7.372 7.756	6.227 6.418 6.610 6.799 6.991 7.182 7.373 7.563 7.947
	<b>22930</b> FourSure® 77 with Armrests, Fully upholstered	8.2	-		1 2 3 4 5 6 7 8 10	6.317 6.538 6.759 6.980 7.199 7.422 7.642 7.863 8.346	

ACCESSORIES	Description	Weight (Kg)	Dimensions (mm)	Price (SEK)
	<b>GRIP HOLE</b> Available for chairs without inside – and full upholstery			189

SURCHARGE	Price (SEK)
<b>FRAME OPTIONAL</b> 	194





## FEATURES

- Armrest options
- Swivel with freefloat in seat/back
- Return mechanism options
- Polyamide glides as standard
- Teflon or felt glides and soft castor options
- Soft castor options (fixed cone without swivel and return)
- We do not recommend suspensions to fully upholstered version

For product information visit [oceefour.com](http://oceefour.com) ↗

## SHELL COLOURS

Standard Polypropylene



## FRAME COLOURS



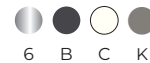

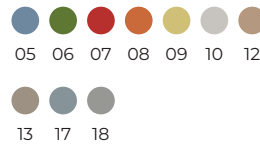

Standard



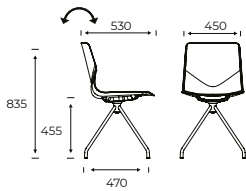

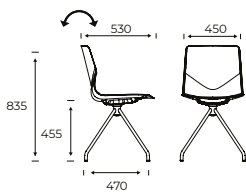

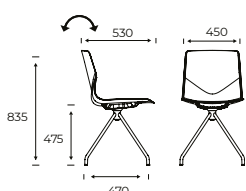

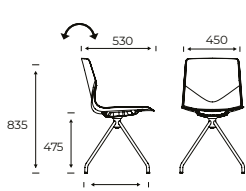

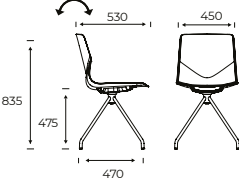

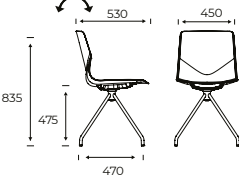

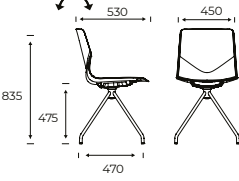

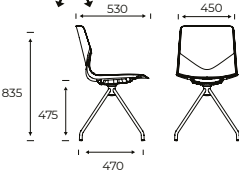

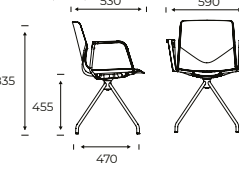

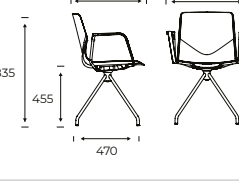

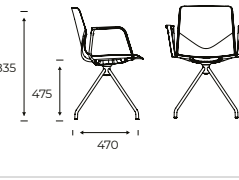

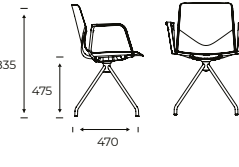
Optional Polypropylene



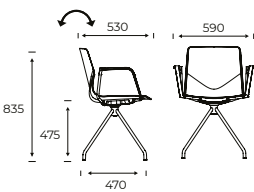

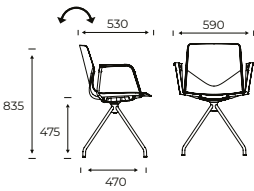
For full colour details [go to page 250](#) ↗

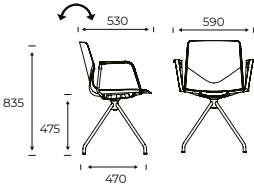
Product	Description (Item nr)	Weight (Kg)	Dimensions (mm)	Band	Standard PP (SEK)	Optional PP (SEK)
	<b>23001</b> FourSure® 11, Polypropylene shell, With tilt	6.7		-	3.627	3.818
	<b>23003</b> FourSure® 11, Polypropylene shell, With tilt with return	6.6		-	4.800	4.991
	<b>23011</b> FourSure® 11, Seat pad, With tilt	7.1		1 2 3 4 5 6 7 8 10	4.889 4.984 5.079 5.173 5.265 5.361 5.456 5.550 5.768	5.080 5.175 5.270 5.364 5.456 5.552 5.647 5.741 5.959
	<b>23013</b> FourSure® 11, Seat pad, With tilt with return	7.1		1 2 3 4 5 6 7 8 10	6.062 6.157 6.252 6.346 6.438 6.534 6.629 6.723 6.941	6.253 6.348 6.443 6.537 6.629 6.725 6.820 6.914 7.132

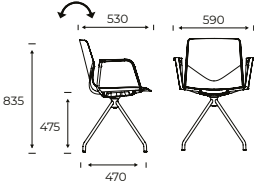
Product	Description (Item nr)	Weight (Kg)	Dimensions (mm)	Band	Standard PP (SEK)	Optional PP (SEK)
	<b>23021</b> FourSure® 11, Inside upholstery, With tilt	7.5		1 2 3 4 5 6 7 8 10	6.045 6.236 6.428 6.617 6.809 7.000 7.191 7.381 7.765	6.236 6.427 6.619 6.808 7.000 7.191 7.382 7.572 7.956
	<b>23023</b> FourSure® 11, Inside upholstery, With tilt with return	7.4		1 2 3 4 5 6 7 8 10	7.218 7.409 7.601 7.790 7.982 8.173 8.364 8.554 8.938	7.409 7.600 7.792 7.981 8.173 8.364 8.555 8.745 9.129
	<b>23031</b> FourSure® 11, Fully upholstered, With tilt	7		1 2 3 4 5 6 7 8 10	6.326 6.547 6.768 6.989 7.208 7.431 7.651 7.872 8.355	
	<b>23033</b> FourSure® 11, Fully upholstered, With tilt with return	6.9		1 2 3 4 5 6 7 8 10	7.499 7.720 7.941 8.162 8.381 8.604 8.824 9.045 9.528	
	<b>23101</b> FourSure® 11 with Loop Armrests, Polypropylene shell, With tilt	7.8		-	4.780	4.971
	<b>23103</b> FourSure® 11 with Loop Armrests, Polypropylene shell, With tilt with return	7.7		-	5.953	6.144
	<b>23111</b> FourSure® 11 with Loop Armrests, Seat pad, With tilt	8.3		1 2 3 4 5 6 7 8 10	6.042 6.137 6.232 6.326 6.418 6.514 6.609 6.703 6.921	6.233 6.328 6.423 6.517 6.609 6.705 6.800 6.894 7.112
	<b>23113</b> FourSure® 11 with Loop Armrests, Seat pad, With tilt with return	8.2		1 2 3 4 5 6 7 8 10	7.215 7.310 7.405 7.499 7.591 7.687 7.782 7.876 8.094	7.406 7.501 7.596 7.690 7.782 7.878 7.973 8.067 8.285

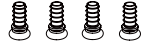
Product	Description (Item nr)	Weight (Kg)	Dimensions (mm)	Band	Standard PP (SEK)	Optional PP (SEK)
	<b>23121</b> FourSure® 11 with Loop Armrests, Inside upholstery, With tilt	8.7		1 2 3 4 5 6 7 8 10	7.198 7.389 7.581 7.770 7.962 8.153 8.344 8.534 8.918	7.389 7.580 7.772 7.961 8.153 8.344 8.535 8.725 9.109
	<b>23123</b> FourSure® 11 with Loop Armrests, Inside upholstery, With tilt with return	8.6		1 2 3 4 5 6 7 8 10	8.371 8.562 8.754 8.943 9.135 9.326 9.517 9.707 10.091	8.562 8.753 8.945 9.134 9.326 9.517 9.708 9.898 10.282
	<b>23131</b> FourSure® 11 with Loop Armrests, Fully upholstered, With tilt	7.9		1 2 3 4 5 6 7 8 10	7.479 7.700 7.921 8.142 8.361 8.584 8.804 9.025 9.508	
	<b>23133</b> FourSure® 11 with Loop Armrests, Fully upholstered, With tilt with return	8.1		1 2 3 4 5 6 7 8 10	8.652 8.873 9.094 9.315 9.534 9.757 9.977 10.198 10.681	

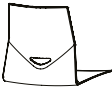
ACCESSORIES	Description	Weight (Kg)	Dimensions (mm)	Price (SEK)
	<b>CHAIR FEET</b> Castors			876
	<b>CHAIR FEET</b> Felt glides, set of 4 pcs. height + 0,2 cm	1,82 g x 4		208
	<b>CHAIR FEET</b> Set of 4 pcs. Noise reducing ferrule with big diameter (reduces pressure marks ) Chair height + 0,8 cm	4,8 g x 4		276
	<b>CHAIR FEET</b> Noise reducing ferrule with felt, set of 4 pcs. Chair height + 1 cm	6,6 g x 4		276
	<b>CHAIR FEET</b> Teflon glides, set of 4 pcs. Chair height + 0,2 cm	2,75 g x 4		208
	<b>GRIP HOLE</b> Available for chairs without inside – and full upholstery			189



## FEATURES

- Swivel frame with free float seat/back as standard
- Return mechanism options
- Loop Armchair options
- Polyamide glides as standard
- Teflon or felt glides and soft castor options
- Powder coated frame options
- We do not recommend suspensions to fully upholstered version



For product information visit [oceefour.com](http://oceefour.com) ↗

## SHELL COLOURS

Standard Polypropylene



## FRAME COLOURS

Standard



Optional Polypropylene

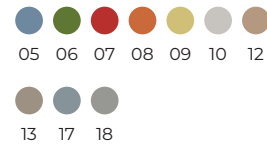









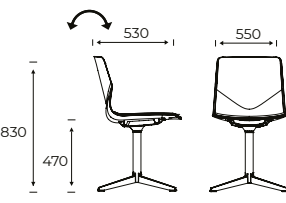

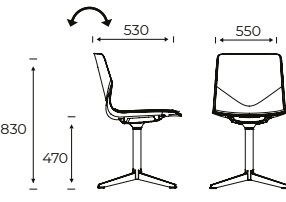

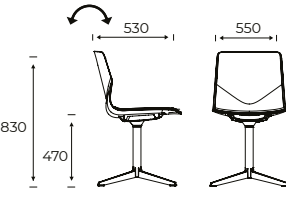

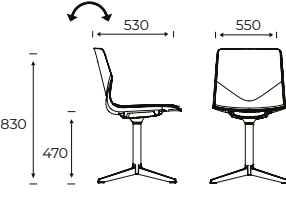

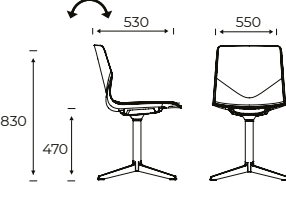

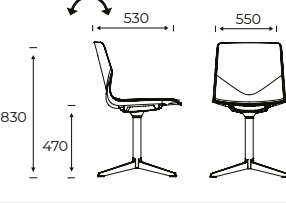

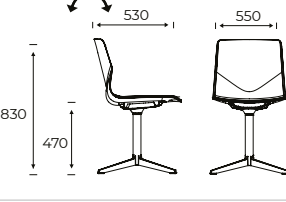

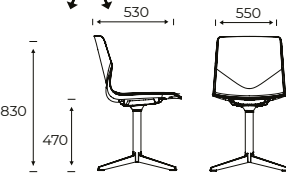



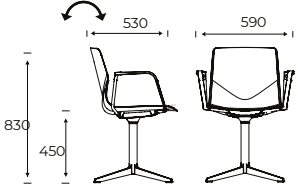

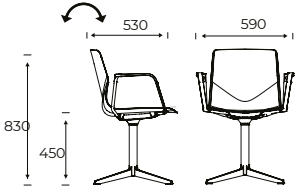

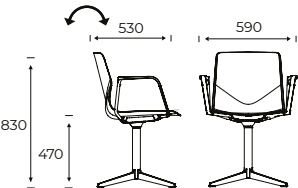
Frame optional\*

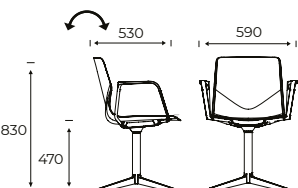

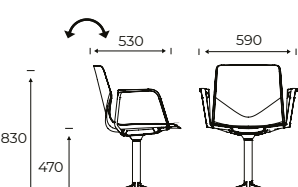

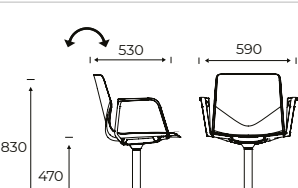

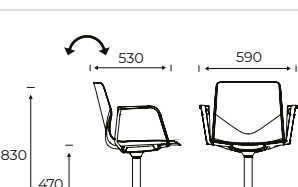

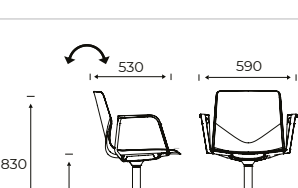
For full colour details [go to page 250](#) ↗

Product	Description (Item nr)	Weight (Kg)	Dimensions (mm)	Band	Standard PP (SEK)	Optional PP (SEK)
	<b>24001</b> FourSure® 99, Polypropylene shell, With tilt	7.2		-	4.767	4.958
	<b>24003</b> FourSure® 99, Polypropylene shell, With tilt with return	7.2		-	5.267	5.458
	<b>24005</b> FourSure® 99, Polypropylene shell, With tilt with gas	7.7		-	5.267	5.458
	<b>24011</b> FourSure® 99, Seat pad, With tilt	7.7		1 2 3 4 5 6 7 8 10	6.029 6.124 6.219 6.313 6.405 6.501 6.596 6.690 6.908	6.220 6.315 6.410 6.504 6.596 6.692 6.787 6.881 7.099

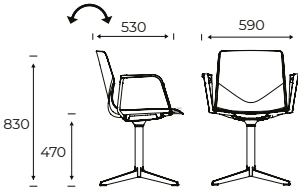
Product	Description (Item nr)	Weight (Kg)	Dimensions (mm)	Band	Standard PP (SEK)	Optional PP (SEK)
	<b>24013</b> FourSure® 99, Seat pad, With tilt with return	7.7		1 2 3 4 5 6 7 8 10	6.529 6.624 6.719 6.813 6.905 7.001 7.096 7.190 7.408	6.720 6.815 6.910 7.004 7.096 7.192 7.287 7.381 7.599
	<b>24015</b> FourSure® 99, Seat pad, With tilt with gas	8.6		1 2 3 4 5 6 7 8 10	6.529 6.624 6.719 6.813 6.905 7.001 7.096 7.190 7.408	6.720 6.815 6.910 7.004 7.096 7.192 7.287 7.381 7.599
	<b>24021</b> FourSure® 99, Inside upholstery, With tilt	8.1		1 2 3 4 5 6 7 8 10	7.185 7.376 7.568 7.757 7.949 8.140 8.331 8.521 8.905	7.376 7.567 7.759 7.948 8.140 8.331 8.522 8.712 9.096
	<b>24023</b> FourSure® 99, Inside upholstery, With tilt with return	8.1		1 2 3 4 5 6 7 8 10	7.685 7.876 8.068 8.257 8.449 8.640 8.831 9.021 9.405	7.876 8.067 8.259 8.448 8.640 8.831 9.022 9.212 9.596
	<b>24025</b> FourSure® 99, Inside upholstery, With tilt with gas	9		1 2 3 4 5 6 7 8 10	7.685 7.876 8.068 8.257 8.449 8.640 8.831 9.021 9.405	7.876 8.067 8.259 8.448 8.640 8.831 9.022 9.212 9.596
	<b>24031</b> FourSure® 99, Fully upholstered, With tilt	7.5		1 2 3 4 5 6 7 8 10	7.466 7.687 7.908 8.129 8.348 8.571 8.791 9.012 9.495	
	<b>24033</b> FourSure® 99, Fully upholstered, With tilt with return	7.5		1 2 3 4 5 6 7 8 10	7.966 8.187 8.408 8.629 8.848 9.071 9.291 9.512 9.995	
	<b>24035</b> FourSure® 99, Fully upholstered, With tilt with gas	-		1 2 3 4 5 6 7 8 10	7.966 8.187 8.408 8.629 8.848 9.071 9.291 9.512 9.995	

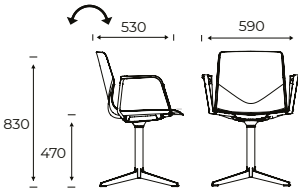
Product	Description (Item nr)	Weight (Kg)	Dimensions (mm)	Band	Standard PP (SEK)	Optional PP (SEK)
	<b>24101</b> FourSure® 99 with Loop Armrests, Polypropylene shell, With tilt	8.5		-	5.918	6.109
	<b>24103</b> FourSure® 99 with Loop Armrests, Polypropylene shell, With tilt with return	8.5		-	6.418	6.609
	<b>24105</b> FourSure® 99 with Loop Armrests, Polypropylene shell, With tilt with gas	9.5		-	6.418	6.609
	<b>24111</b> FourSure® 99 with Loop Armrests, Seat pad, With tilt	9.1		1 2 3 4 5 6 7 8 10	7.180 7.275 7.370 7.464 7.556 7.652 7.747 7.841 8.059	7.371 7.466 7.561 7.655 7.747 7.843 7.938 8.032 8.250
	<b>24113</b> FourSure® 99 with Loop Armrests, Seat pad, With tilt with return	9		1 2 3 4 5 6 7 8 10	7.680 7.775 7.870 7.964 8.056 8.152 8.247 8.341 8.559	7.871 7.966 8.061 8.155 8.247 8.343 8.438 8.532 8.750
	<b>24115</b> FourSure® 99 with Loop Armrests, Seat pad, With tilt with gas	10		1 2 3 4 5 6 7 8 10	7.680 7.775 7.870 7.964 8.056 8.152 8.247 8.341 8.559	7.871 7.966 8.061 8.155 8.247 8.343 8.438 8.532 8.750
	<b>24121</b> FourSure® 99 with Loop Armrests, Inside upholstery, With tilt	9.4		1 2 3 4 5 6 7 8 10	8.336 8.527 8.719 8.908 9.100 9.291 9.482 9.672 10.056	8.527 8.718 8.910 9.099 9.291 9.482 9.673 9.863 10.247
	<b>24123</b> FourSure® 99 with Loop Armrests, Inside upholstery, With tilt with return	9.4		1 2 3 4 5 6 7 8 10	8.836 9.027 9.219 9.408 9.600 9.791 9.982 10.172 10.556	9.027 9.218 9.410 9.599 9.791 9.982 10.173 10.363 10.747

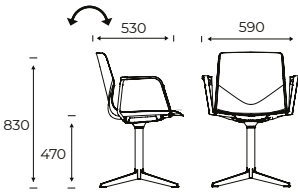

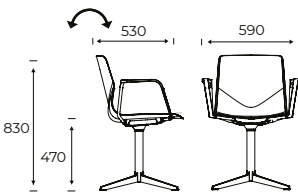
Product	Description (Item nr)	Weight (Kg)	Dimensions (mm)	Band	Standard PP (SEK)	Optional PP (SEK)
	<b>24125</b> FourSure® 99 with Loop Armrests, Inside upholstery, With tilt with gas	10.4		1 2 3 4 5 6 7 8 10	8.836 9.027 9.219 9.408 9.600 9.791 9.982 10.172 10.556	9.027 9.218 9.410 9.599 9.791 9.982 10.173 10.363 10.747
	<b>24131</b> FourSure® 99 with Loop Armrests, Fully upholstered, With tilt	8.8		1 2 3 4 5 6 7 8 10	8.617 8.838 9.059 9.280 9.499 9.722 9.942 10.163 10.646	
	<b>24133</b> FourSure® 99 with Loop Armrests, Fully upholstered, With tilt with return	8.8		1 2 3 4 5 6 7 8 10	9.117 9.338 9.559 9.780 9.999 10.222 10.442 10.663 11.146	
	<b>24135</b> FourSure® 99 with Loop Armrests, Fully upholstered, With tilt with gas	8.5		1 2 3 4 5 6 7 8 10	9.117 9.338 9.559 9.780 9.999 10.222 10.442 10.663 11.146	

ACCESSORIES	Description	Weight (Kg)	Dimensions (mm)	Price (SEK)
	<b>CHAIR FEET</b> Castors			1.154
	<b>CHAIR FEET</b> Felt glides, set of 4 pcs. height + 0,2 cm	1,82 g x 4		208

SURCHARGE		Price (SEK)
<b>FRAME OPTIONAL</b>	 B C K	1058



# EU Ecolabel FourCast® 2

Design by Strand+Hvass

[Content ↗](#)



## FEATURES



- The chair consists of 50 % recycled plastic
- Limitation of substances that are harmful to health and the environment
- Linking device optional on frames or under seat
- Matches table height 74 cm, 90 cm & 105 cm
- Polyamide glides as standard
- Stackable on matching trolley

For product information visit [oceefour.com](http://oceefour.com) ↗

## SHELL COLOURS

Standard Polypropylene







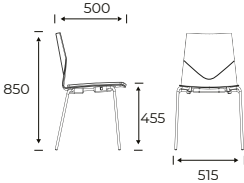

## FRAME COLOURS

Standard

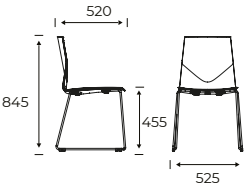

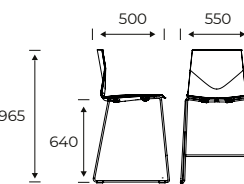

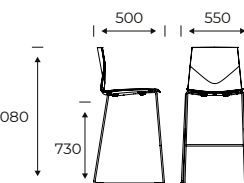
For full colour details [go to page 236](#) ↗







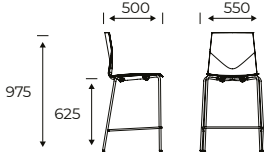

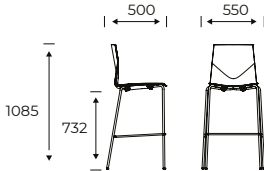
Product	Description (Item nr)	Weight (Kg)	Stacking on floor	Dimensions (mm)	Band	Standard PP (SEK)
	<b>32500</b> FourCast@ 2 Four, Polypropylene shell	4.8	-		-	2.290
	<b>33200</b> FourCast@ 2 Line, Polypropylene shell	5.7	-		-	2.776
	<b>33800</b> FourCast@ 2 Counter, Polypropylene shell	6.6	-		-	3.730
	<b>33900</b> FourCast@ 2 High, Polypropylene shell	7.3	-		-	3.815

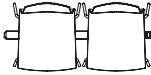
# EU Ecolabel FourCast® 2

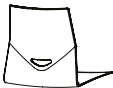
[Content ↗](#)

Design by Strand+Hvass

Product	Description (Item nr)	Weight (Kg)	Stacking on floor	Dimensions (mm)	Band	Standard PP (SEK)
	<b>34000</b> FourCast@ 2 Counter Four, Polypropylene shell	7.7	-		-	3.492
	<b>34100</b> FourCast@ 2 High Four, Polypropylene shell	6.7	-		-	3.492

ACCESSORIES	Description	Weight (Kg)	Dimensions (mm)	Price (SEK)
	<b>CHAIR FEET</b> Felt glides, set of 4 pcs. height + 0,2 cm	1,82 g x 4		208
	<b>CHAIR FEET</b> Teflon glides, set of 4 pcs. Chair height + 0,2 cm	2,75 g x 4		208
	<b>LINKING DEVICE</b> Chair linking	0,4 KG	C/C 535 mm C/C with armrest 585 mm C/C with Loop armrest 625 mm	417
	<b>LINKING DEVICE</b> Chair linking		C/C 540 mm C/C with armrest 540 mm	390
	<b>GRIP HOLE</b> Available for chairs without inside – and full upholstery			189
	<b>SEAT ROW NUMBER - ACSR0201</b> 11 mm - no. 1 -25	29 g		1.579
	<b>SEAT ROW NUMBER - ACSR0202</b> 11 mm - no. 26 -50	29 g		1.579
	<b>SEAT ROW NUMBER - ACSR0101</b> 16 mm - no. 1 -25	29 g		1.579
	<b>SEAT ROW NUMBER - ACSR0102</b> 16 mm - no. 26 -50	29 g		1.579
	<b>CHAIR TROLLEY - 200X0</b> 25 chairs without upholstery	33,5 Kg	1100 x 560 x 1970 mm	8.859

# FourCast® 2 Four

Design by Strand+Hvass

[Content ↗](#)



## FEATURES

- Armrest options and wooden legs options\*
- Linking device under seat options
- Monochrome powder coating on frames options
- Polyamide glides as standard
- Inno® Note tablet options
- Stackable on matching trolley
- We do not recommend suspensions for fully upholstered versions



For product information visit [oceefour.com](http://oceefour.com) ↗

## SHELL COLOURS

Standard Polypropylene



## FRAME COLOURS

Standard

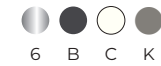



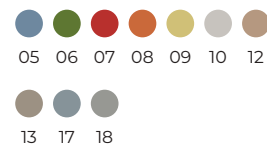



Optional Polypropylene

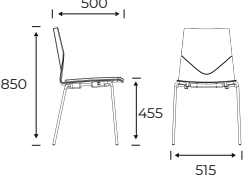

Frame optional\*

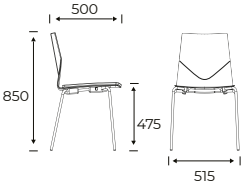

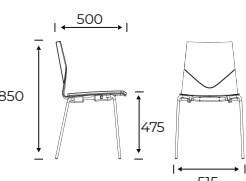

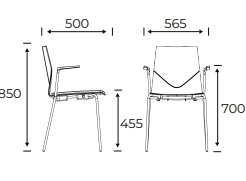



For full colour details [go to page 236](#) ↗



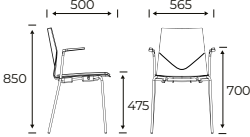

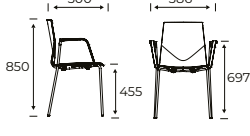

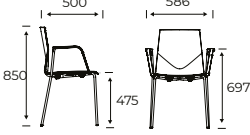

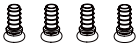

Product	Description (Item nr)	Weight (Kg)	Stacking on floor	Dimensions (mm)	Band	Standard PP (SEK)	Optional PP (SEK)
	<b>32500</b> FourCast® 2 Four, Polypropylene shell	4.8	12		-	2.290	2.481
	<b>32510</b> FourCast® 2 Four, Seat pad	5.8	10		1 2 3 4 5 6 7 8 10	3.552 3.647 3.742 3.836 3.928 4.024 4.119 4.213 4.431	3.743 3.838 3.933 4.027 4.119 4.215 4.310 4.404 4.622
	<b>32530</b> FourCast® 2 Four, Fully upholstered	4.1	6		1 2 3 4 5 6 7 8 10	4.999 5.220 5.443 5.663 5.882 6.103 6.325 6.544 7.030	
	<b>32600</b> FourCast® 2 Four with Armrests, Polypropylene shell	5.3	12		-	3.443	3.634

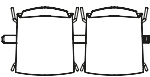
# FourCast® 2 Four

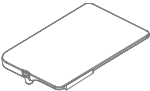
Design by Strand+Hvass

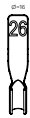
[Content ↗](#)

Product	Description (Item nr)	Weight (Kg)	Stacking on floor	Dimensions (mm)	Band	Standard PP (SEK)	Optional PP (SEK)
	<b>32610</b> FourCast® 2 Four with Armrests, Seat pad	6.3	10		1	4.705	4.896
					2	4.800	4.991
					3	4.895	5.086
					4	4.989	5.180
					5	5.081	5.272
					6	5.177	5.368
					7	5.272	5.463
					8	5.366	5.557
					10	5.584	5.775
						<b>32630</b> FourCast® 2 Four with Armrests, Fully upholstered	4.6
2	6.373						
3	6.596						
4	6.816						
5	7.035						
6	7.256						
7	7.478						
8	7.697						
10	8.183						
	<b>32700</b> FourCast® 2 Four with Loop Armrests, Polypropylene shell	5.9	12				
	<b>32710</b> FourCast® 2 Four with Loop Armrests, Seat pad	6.8	10		1	4.705	4.896
					2	4.800	4.991
					3	4.895	5.086
					4	4.989	5.180
					5	5.081	5.272
					6	5.177	5.368
					7	5.272	5.463
					8	5.366	5.557
					10	5.584	5.775
						<b>32730</b> FourCast® 2 Four with Loop Armrests, Fully upholstered	5.2
2	6.373						
3	6.596						
4	6.816						
5	7.035						
6	7.256						
7	7.478						
8	7.697						
10	8.183						

ACCESSORIES	Description	Weight (Kg)	Dimensions (mm)	Price (SEK)
	<b>CHAIR FEET</b> Felt glides, set of 4 pcs. height + 0,2 cm	1,82 g x 4		208
	<b>CHAIR FEET</b> Set of 4 pcs. Noise reducing ferrule with big diameter (reduces pressure marks ) Chair height + 0,8 cm	4,8 g x 4		276
	<b>CHAIR FEET</b> Noise reducing ferrule with felt, set of 4 pcs. Chair height + 1 cm	6,6 g x 4		276
	<b>CHAIR FEET</b> Teflon glides, set of 4 pcs. Chair height + 0,2 cm	2,75 g x 4		208
	<b>LINKING DEVICE</b> Chair linking	0,4 KG	C/C 535 mm C/C with armrest 585 mm C/C with Loop armrest 625 mm	417
	<b>GRIP HOLE</b> Available for chairs without inside – and full upholstery			189
	<b>INNO</b> Inno® Note in black, removable and foldable. Not available for chairs with Loop armrest and chairs with wooden legs.	1,4 KG	225 x 325 x 10 mm	1.522
	<b>SEAT ROW NUMBER - ACSR0101</b> 16 mm - no.1 -25	29 g		1.579
	<b>SEAT ROW NUMBER - ACSR0102</b> 16 mm - no.26 -50	29 g		1.579
	<b>INNO@NOTE TROLLEY - 20100007</b> Trolley for Inno® Note. Room for 51 Inno® Notes.	58,5 Kg	1532 x 662 x 1199 mm	19.942
	<b>CHAIR TROLLEY - 200X0</b> 25 chairs without upholstery	33,5 Kg	1100 x 560 x 1970 mm	8.859
	<b>CHAIR TROLLEY - 200X0</b> 20 chairs with seat pad or 18 chairs with full upholstery	33,5 Kg	1100 x 560 x 1910 / 1980 mm	10.373
	<b>SACK TROLLEY - 200X1</b> 12 chairs without upholstery, 10 chairs with full upholstery			4.918

# FourCast® 2 Four

Design by Strand+Hvass

[Content ↗](#)

SURCHARGE		Price (SEK)
FRAME OPTIONAL	 7 A D E F M N O Q S T	194

# FourCast® 2 Four - Veneer

Design by Strand+Hvass

[Content ↗](#)



## FEATURES

- Armrest options and wooden legs options\*
- Linking device under seat options
- Monochrome powder coating on frames options
- Polyamide glides as standard
- Inno® Note tablet options
- Stackable on matching trolley
- We do not recommend suspensions to black lacquered versions



For product information visit [oceefour.com](http://oceefour.com) ↗

## SHELL COLOURS

Veneer



## FRAME COLOURS







Standard

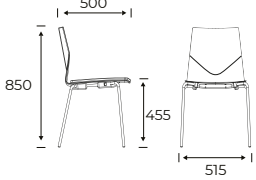

Frame optional\*

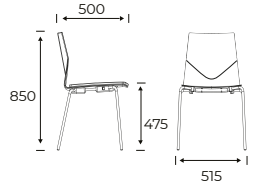

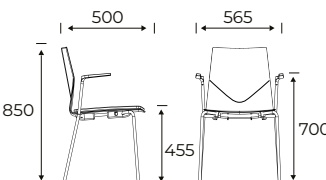

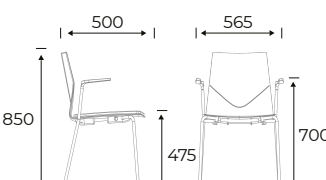
For full colour details [go to page 236](#) ↗

Product	Description (Item nr)	Weight (Kg)	Stacking on floor	Dimensions (mm)	Band	Veneer (SEK)
	<b>32540</b> FourCast® 2 Four, Wooden shell	3.3	12		-	3.212
	<b>32550</b> FourCast® 2 Four, Seat pad, wooden shell	4.8	10		1 2 3 4 5 6 7 8 10	4.474 4.569 4.664 4.758 4.850 4.946 5.041 5.135 5.353
	<b>32640</b> FourCast® 2 Four with Armrests, Wooden shell	3.9	6		-	4.365
	<b>32650</b> FourCast® 2 Four with Armrests, Seat pad, wooden shell	5.3	12		1 2 3 4 5 6 7 8 10	5.627 5.722 5.817 5.911 6.003 6.099 6.194 6.288 6.506

# FourCast® 2 Four - Veneer

[Content ↗](#)

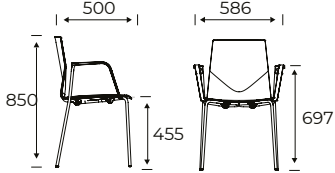
Design by Strand+Hvass

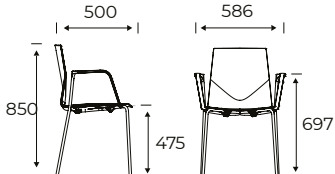







Product	Description (Item nr)	Weight (Kg)	Stacking on floor	Dimensions (mm)	Band	Veneer (SEK)
	<b>32740</b> FourCast® 2 Four with Loop Armrests, Wooden shell	4.4	10		-	4.365
	<b>32750</b> FourCast® 2 Four with Loop Armrests, Seat pad, wooden shell	5.8	6		1 2 3 4 5 6 7 8 10	5.627 5.722 5.817 5.911 6.003 6.099 6.194 6.288 6.506

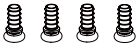

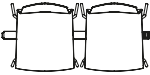
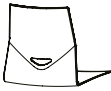
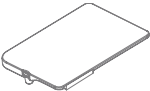
# FourCast® 2 Four - Veneer

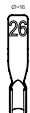
Design by Strand+Hvass

[Content ↗](#)

ACCESSORIES	Description	Weight (Kg)	Dimensions (mm)	Price (SEK)
	<b>CHAIR FEET</b> Felt glides, set of 4 pcs. height + 0,2 cm	1,82 g x 4		208
	<b>CHAIR FEET</b> Set of 4 pcs. Noise reducing ferrule with big diameter (reduces pressure marks ) Chair height + 0,8 cm	4,8 g x 4		276
	<b>CHAIR FEET</b> Noise reducing ferrule with felt, set of 4 pcs. Chair height + 1 cm	6,6 g x 4		276
	<b>CHAIR FEET</b> Teflon glides, set of 4 pcs. Chair height + 0,2 cm	2,75 g x 4		208
	<b>LINKING DEVICE</b> Chair linking	0,4 KG	C/C 535 mm C/C with armrest 585 mm C/C with Loop armrest 625 mm	417
	<b>GRIP HOLE</b> Available for chairs without inside - and full upholstery			189
	<b>INNO</b> Inno® Note in black, removable and foldable. Not available for chairs with Loop armrest and chairs with wooden legs.	1,4 KG	225 x 325 x 10 mm	1.522
	<b>SEAT ROW NUMBER - ACSR0101</b> 16 mm - no.1 -25	29 g		1.579
	<b>SEAT ROW NUMBER - ACSR0102</b> 16 mm - no.26 -50	29 g		1.579
	<b>INNO@NOTE TROLLEY - 20100007</b> Trolley for Inno® Note. Room for 51 Inno® Notes.	58,5 Kg	1532 x 662 x 1199 mm	19.942
	<b>CHAIR TROLLEY - 200X0</b> 25 chairs without upholstery	33,5 Kg	1100 x 560 x 1970 mm	8.859
	<b>CHAIR TROLLEY - 200X0</b> 20 chairs with seat pad or 18 chairs with full upholstery	33,5 Kg	1100 x 560 x 1910 / 1980 mm	10.373
	<b>SACK TROLLEY - 200X1</b> 12 chairs without upholstery, 10 chairs with full upholstery			4.918

# FourCast® 2 Four - Veneer

Design by Strand+Hvass

[Content ↗](#)

SURCHARGE		Price (SEK)
<b>FRAME OPTIONAL</b>	 7 A D E F M N O Q S T	194
	 P	473

# FourCast® 2 Line

Design by Strand+Hvass

[Content ↗](#)



## FEATURES

- Armrest options
- Linking device optional on frames or under seat
- Monochrome powder coating on frames options
- Polyamide glides as standard
- Inno® Note tablet options
- Stackable on matching trolley
- Outdoor options
- We do not recommend suspensions for fully upholstered version



For product information visit [oceefour.com](http://oceefour.com) ↗

## SHELL COLOURS

Standard Polypropylene



## FRAME COLOURS

Standard



Optional Polypropylene

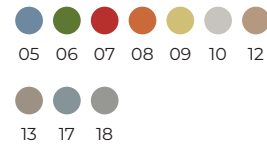

Frame optional\*





For full colour details [go to page 236](#) ↗

Product	Description (Item nr)	Weight (Kg)	Stacking on floor	Dimensions (mm)	Band	Standard PP (SEK)	Optional PP (SEK)
	<b>33200</b> FourCast® 2 Line, Polypropylene shell	5.7	12		-	2.776	2.967
	<b>33210</b> FourCast® 2 Line, Seat pad	6.7	10		1 2 3 4 5 6 7 8 10	4.038 4.133 4.228 4.322 4.414 4.510 4.605 4.699 4.917	4.229 4.324 4.419 4.513 4.605 4.701 4.796 4.890 5.108
	<b>33230</b> FourCast® 2 Line, Fully upholstered	5	8		1 2 3 4 5 6 7 8 10	5.485 5.706 5.929 6.149 6.368 6.589 6.811 7.030 7.516	
	<b>33300</b> FourCast® 2 Line with Armrests, Polypropylene shell	6.5	12		-	3.715	3.906

# FourCast® 2 Line

Design by Strand+Hvass

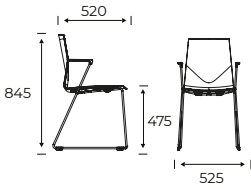







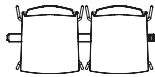

[Content ↗](#)

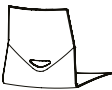
Product	Description (Item nr)	Weight (Kg)	Stacking on floor	Dimensions (mm)	Band	Standard PP (SEK)	Optional PP (SEK)
	<b>33310</b> FourCast® 2 Line with Armrests, Seat pad	7.4	10		1	4.977	5.168
					2	5.072	5.263
					3	5.167	5.358
					4	5.261	5.452
					5	5.353	5.544
					6	5.449	5.640
					7	5.544	5.735
					8	5.638	5.829
					10	5.856	6.047
						<b>33330</b> FourCast® 2 Line with Armrests, Fully upholstered	5.8
2	6.645						
3	6.868						
4	7.088						
5	7.307						
6	7.528						
7	7.750						
8	7.969						
10	8.455						

# FourCast® 2 Line

Design by Strand+Hvass

[Content ↗](#)

ACCESSORIES	Description	Weight (Kg)	Dimensions (mm)	Price (SEK)
	<b>CHAIR FEET</b> Felt glides, set of 4 pcs. height + 0,2 cm	1,82 g x 4		208
	<b>CHAIR FEET</b> Teflon glides, set of 4 pcs. Chair height + 0,2 cm	2,75 g x 4		208
	<b>LINKING DEVICE</b> Chair linking	0,4 KG	C/C 535 mm C/C with armrest 585 mm C/C with Loop armrest 625 mm	417
	<b>LINKING DEVICE</b> Chair linking		C/C 540 mm C/C with armrest 540 mm	390
	<b>GRIP HOLE</b> Available for chairs without inside – and full upholstery			189
	<b>INNO</b> Inno® Note in black, removable and foldable. Not available for chairs with Loop armrest and chairs with wooden legs.	1,4 KG	225 x 325 x 10 mm	1.522
	<b>SEAT ROW NUMBER - ACSR0201</b> 11 mm - no. 1 -25	29 g		1.579
	<b>SEAT ROW NUMBER - ACSR0202</b> 11 mm - no. 26 -50	29 g		1.579
	<b>INNO@NOTE TROLLEY - 20100007</b> Trolley for Inno® Note. Room for 51 Inno® Notes.	58,5 Kg	1532 x 662 x 1199 mm	19.942
	<b>CHAIR TROLLEY - 200X0</b> 30 chairs without upholstery	33,5 Kg	1100 x 560 x 1970 mm	8.859
	<b>CHAIR TROLLEY - 200X0</b> 19 chairs with seat pad or 20 chairs with full upholstery	33,5 Kg	1100 x 560 x 1910 / 1980 mm	10.373
	<b>SACK TROLLEY - 200X1</b> 12 chairs without upholstery, 10 chairs with full upholstery			4.918

SURCHARGE		Price (SEK)
<b>FRAME OPTIONAL</b>	 7 A D E F M N O Q S T	194

# FourCast® 2 Line - Veneer

Design by Strand+Hvass

[Content ↗](#)



## FEATURES

- Armrest options
- Linking device optional on frames or under seat
- Monochrome powder coating on frames options
- Polyamide glides as standard
- Inno® Note tablet options
- Stackable on matching trolley
- We do not recommend suspensions to black lacquered versions



For product information visit [oceefour.com](https://oceefour.com) ↗

## SHELL COLOURS

Veneer



## FRAME COLOURS

Standard

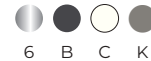

Frame optional\*











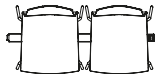

For full colour details [go to page 236](#) ↗

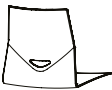
Product	Description (Item nr)	Weight (Kg)	Stacking on floor	Dimensions (mm)	Band	Veneer (SEK)
	<b>33240</b> FourCast® 2 Line, Wooden shell	4.3	12		-	3.698
	<b>33250</b> FourCast® 2 Line, Seat pad, wooden shell	5.6	10		1 2 3 4 5 6 7 8 10	4.960 5.055 5.150 5.244 5.336 5.432 5.527 5.621 5.839
	<b>33340</b> FourCast® 2 Line with Armrests, Wooden shell	5	8		-	4.637
	<b>33350</b> FourCast® 2 Line with Armrests, Seat pad, wooden shell	6.4	10		1 2 3 4 5 6 7 8 10	5.899 5.994 6.089 6.183 6.275 6.371 6.466 6.560 6.778

# FourCast® 2 Line - Veneer

Design by Strand+Hvass

[Content ↗](#)

ACCESSORIES	Description	Weight (Kg)	Dimensions (mm)	Price (SEK)
	<b>CHAIR FEET</b> Felt glides, set of 4 pcs. height + 0,2 cm	1,82 g x 4		208
	<b>CHAIR FEET</b> Teflon glides, set of 4 pcs. Chair height + 0,2 cm	2,75 g x 4		208
	<b>LINKING DEVICE</b> Chair linking	0,4 KG	C/C 535 mm C/C with armrest 585 mm C/C with Loop armrest 625 mm	417
	<b>LINKING DEVICE</b> Chair linking		C/C 540 mm C/C with armrest 540 mm	390
	<b>GRIP HOLE</b> Available for chairs without inside - and full upholstery			189
	<b>INNO</b> Inno® Note in black, removable and foldable. Not available for chairs with Loop armrest and chairs with wooden legs.	1,4 KG	225 x 325 x 10 mm	1.522
	<b>SEAT ROW NUMBER - ACSR0201</b> 11 mm - no. 1 -25	29 g		1.579
	<b>SEAT ROW NUMBER - ACSR0202</b> 11 mm - no. 26 -50	29 g		1.579
	<b>INNO@NOTE TROLLEY - 20100007</b> Trolley for Inno® Note. Room for 51 Inno® Notes.	58,5 Kg	1532 x 662 x 1199 mm	19.942
	<b>CHAIR TROLLEY - 200X0</b> 30 chairs without upholstery	33,5 Kg	1100 x 560 x 1970 mm	8.859
	<b>CHAIR TROLLEY - 200X0</b> 19 chairs with seat pad or 20 chairs with full upholstery	33,5 Kg	1100 x 560 x 1910 / 1980 mm	10.373
	<b>SACK TROLLEY - 200X1</b> 12 chairs without upholstery, 10 chairs with full upholstery			4.918

SURCHARGE		Price (SEK)
<b>FRAME OPTIONAL</b>	 7 A D E F M N O Q S T	194

# FourCast® 2 Counter

Design by Strand+Hvass

[Content ↗](#)



## FEATURES

- Fits table height 90 cm
- Stackable on floor
- Polyamide glides as standard
- Monochrome powder coating on frames options
- Outdoor options
- We do not recommend suspensions to fully upholstered version



For product information visit [oceefour.com](https://oceefour.com) ↗

## SHELL COLOURS

Standard Polypropylene



Optional Polypropylene

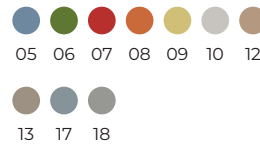

## FRAME COLOURS

Standard

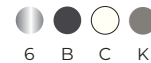

Frame optional\*



For full colour details [go to page 236](#) ↗

Product	Description (Item nr)	Weight (Kg)	Stacking on floor	Dimensions (mm)	Band	Standard PP (SEK)	Optional PP (SEK)
	<b>33800</b> FourCast® 2 Counter, Polypropylene shell	6.6	4		-	3.730	3.921
	<b>33810</b> FourCast® 2 Counter, Seat pad	7.5	4		1 2 3 4 5 6 7 8 10	4.992 5.087 5.182 5.276 5.368 5.464 5.559 5.653 5.871	5.183 5.278 5.373 5.467 5.559 5.655 5.750 5.844 6.062
	<b>33830</b> FourCast® 2 Counter, Fully upholstered	7.1	4		1 2 3 4 5 6 7 8 10	6.439 6.660 6.883 7.103 7.322 7.543 7.765 7.984 8.470	



# FourCast® 2 Counter

Design by Strand+Hvass

[Content ↗](#)

ACCESSORIES	Description	Weight (Kg)	Dimensions (mm)	Price (SEK)
	<b>CHAIR FEET</b> Felt glides, set of 4 pcs. height + 0,2 cm	1,82 g x 4		208
	<b>CHAIR FEET</b> Teflon glides, set of 4 pcs. Chair height + 0,2 cm	2,75 g x 4		208
	<b>GRIP HOLE</b> Available for chairs without inside – and full upholstery			189

SURCHARGE		Price (SEK)
<b>FRAME OPTIONAL</b>	 7 A D E F M N O Q S T	194

# FourCast® 2 Counter - Veneer

Design by Strand+Hvass

[Content](#) ↗



## FEATURES

- Fits table height 90 cm
- Stackable on floor
- Polyamide glides as standard
- Monochrome powder coating on frames options
- We do not recommend suspensions to black lacquered versions



For product information visit [oceefour.com](https://oceefour.com) ↗

## SHELL COLOURS

Veneer



## FRAME COLOURS

Standard

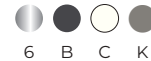

Frame optional\*



For full colour details [go to page 236](#) ↗

Product	Description (Item nr)	Weight (Kg)	Stacking on floor	Dimensions (mm)	Band	Veneer (SEK)
	<b>33840</b> FourCast® 2 Counter, Wooden shell	7.2	4		-	4.652
	<b>33850</b> FourCast® 2 Counter, Seat pad, wooden shell	8.6	4		1 2 3 4 5 6 7 8 10	5.914 6.009 6.104 6.198 6.290 6.386 6.481 6.575 6.793

ACCESSORIES	Description	Weight (Kg)	Dimensions (mm)	Price (SEK)
	<b>CHAIR FEET</b> Felt glides, set of 4 pcs. height + 0,2 cm	1,82 g x 4		208
	<b>CHAIR FEET</b> Teflon glides, set of 4 pcs. Chair height + 0,2 cm	2,75 g x 4		208
	<b>GRIP HOLE</b> Available for chairs without inside - and full upholstery			189

# FourCast® 2 Counter - Veneer

Design by Strand+Hvass

[Content ↗](#)

SURCHARGE		Price (SEK)
FRAME OPTIONAL	 7 A D E F M N O Q S T	194

# FourCast® 2 High

Design by Strand+Hvass

[Content ↗](#)



## FEATURES

- Fits table height 105 cm
- Stackable on floor
- Polyamide glides as standard
- Monochrome powder coating on frames options
- Outdoor options
- We do not recommend suspensions to fully upholstered version



For product information visit [oceefour.com](http://oceefour.com) ↗

## SHELL COLOURS

Standard Polypropylene



Optional Polypropylene

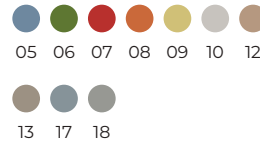

## FRAME COLOURS

Standard

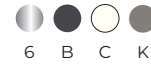

Frame optional\*



For full colour details [go to page 236](#) ↗

Product	Description (Item nr)	Weight (Kg)	Stacking on floor	Dimensions (mm)	Band	Standard PP (SEK)	Optional PP (SEK)
	<b>33900</b> FourCast® 2 High, Polypropylene shell	7.3	4		-	3.815	4.006
	<b>33910</b> FourCast® 2 High, Seat pad	8.3	4		1 2 3 4 5 6 7 8 10	5.077 5.172 5.267 5.361 5.453 5.549 5.644 5.738 5.956	5.268 5.363 5.458 5.552 5.644 5.740 5.835 5.929 6.147
	<b>33930</b> FourCast® 2 High, Fully upholstered	7.8	4		1 2 3 4 5 6 7 8 10	6.524 6.745 6.968 7.188 7.407 7.628 7.850 8.069 8.555	

# FourCast® 2 High

Design by Strand+Hvass

[Content ↗](#)

ACCESSORIES	Description	Weight (Kg)	Dimensions (mm)	Price (SEK)
	<b>CHAIR FEET</b> Felt glides, set of 4 pcs. height + 0,2 cm	1,82 g x 4		208
	<b>CHAIR FEET</b> Teflon glides, set of 4 pcs. Chair height + 0,2 cm	2,75 g x 4		208
	<b>GRIP HOLE</b> Available for chairs without inside – and full upholstery			189

SURCHARGE		Price (SEK)
<b>FRAME OPTIONAL</b>	 7 A D E F M N O Q S T	194

# FourCast® 2 High - Veneer

Design by Strand+Hvass

[Content](#) ↗



## FEATURES

- Fits table height 105 cm
- Stackable on floor
- Polyamide glides as standard
- Monochrome powder coating on frames options
- We do not recommend suspensions to black lacquered versions

For product information visit [oceefour.com](http://oceefour.com) ↗

## SHELL COLOURS

Veneer



## FRAME COLOURS

Standard



Frame optional\*



For full colour details [go to page 236](#) ↗

Product	Description (Item nr)	Weight (Kg)	Stacking on floor	Dimensions (mm)	Band	Veneer (SEK)
	<b>33940</b> FourCast® 2 High, Wooden shell	8	4		-	4.737
	<b>33950</b> FourCast® 2 High, Seat pad, wooden shell	9.4	4		1 2 3 4 5 6 7 8 10	5.999 6.094 6.189 6.283 6.375 6.471 6.566 6.660 6.878

ACCESSORIES	Description	Weight (Kg)	Dimensions (mm)	Price (SEK)
	<b>CHAIR FEET</b> Felt glides, set of 4 pcs. height + 0,2 cm	1,82 g x 4		208
	<b>CHAIR FEET</b> Teflon glides, set of 4 pcs. Chair height + 0,2 cm	2,75 g x 4		208
	<b>GRIP HOLE</b> Available for chairs without inside - and full upholstery			189

# FourCast® 2 High - Veneer

Design by Strand+Hvass

[Content ↗](#)

SURCHARGE		Price (SEK)
FRAME OPTIONAL	 <p>7 A D E F M N O Q S T</p>	194

# FourCast® 2 Counter Four

Design by Strand+Hvass

[Content ↗](#)



## FEATURES

- Fits table height 90 cm
- Stackable on floor
- Polyamide glides as standard
- Monochrome powder coating on frames options
- We do not recommend suspensions to fully upholstered version



For product information visit [oceefour.com](https://oceefour.com) ↗

## SHELL COLOURS

Standard Polypropylene



## FRAME COLOURS

Standard

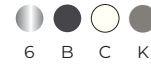

Optional Polypropylene

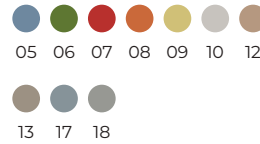

Frame optional\*



For full colour details [go to page 236](#) ↗

Product	Description (Item nr)	Weight (Kg)	Stacking on floor	Dimensions (mm)	Band	Standard PP (SEK)	Optional PP (SEK)
	<b>34000</b> FourCast® 2 Counter Four, Polypropylene shell	7.7	4		-	3.492	3.683
	<b>34010</b> FourCast® 2 Counter Four, Seat pad	8.6	4		1 2 3 4 5 6 7 8 10	4.754 4.849 4.944 5.038 5.130 5.226 5.321 5.415 5.633	4.945 5.040 5.135 5.229 5.321 5.417 5.512 5.606 5.824
	<b>34030</b> FourCast® 2 Counter Four, Fully upholstered	8.2	4		1 2 3 4 5 6 7 8 10	6.201 6.422 6.645 6.865 7.084 7.305 7.527 7.746 8.232	



# FourCast® 2 Counter Four

Design by Strand+Hvass

[Content ↗](#)

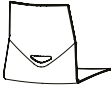
ACCESSORIES	Description	Weight (Kg)	Dimensions (mm)	Price (SEK)
	<b>CHAIR FEET</b> Felt glides, set of 4 pcs. height + 0,2 cm	1,82 g x 4		208
	<b>CHAIR FEET</b> Teflon glides, set of 4 pcs. Chair height + 0,2 cm	2,75 g x 4		208
	<b>GRIP HOLE</b> Available for chairs without inside – and full upholstery			189

SURCHARGE		Price (SEK)
<b>FRAME OPTIONAL</b>	 7 A D E F M N O Q S T	194

# FourCast® 2 Counter Four - Veneer

Design by Strand+Hvass

[Content](#) ↗



## FEATURES

- Fits table height 90 cm
- Stackable on floor
- Polyamide glides as standard
- Monochrome powder coating on frames options
- We do not recommend suspensions to black lacquered versions



For product information visit [oceefour.com](https://oceefour.com) ↗

## SHELL COLOURS

Veneer



## FRAME COLOURS



Standard



Frame optional\*

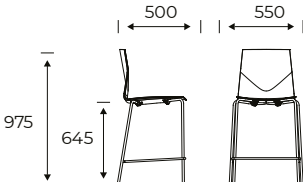

For full colour details [go to page 236](#) ↗

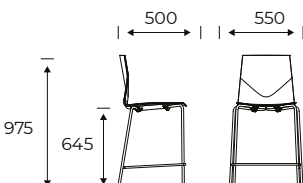
Product	Description (Item nr)	Weight (Kg)	Stacking on floor	Dimensions (mm)	Band	Veneer (SEK)
	<b>34040</b> FourCast® 2 Counter Four, Wooden shell	8.3	4		-	4.414
	<b>34050</b> FourCast® 2 Counter Four, Seat pad, wooden shell	9.7	4		1 2 3 4 5 6 7 8 10	5.676 5.771 5.866 5.960 6.052 6.148 6.243 6.337 6.555

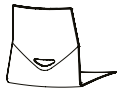
ACCESSORIES	Description	Weight (Kg)	Dimensions (mm)	Price (SEK)
	<b>CHAIR FEET</b> Felt glides, set of 4 pcs. height + 0,2 cm	1,82 g x 4		208
	<b>CHAIR FEET</b> Teflon glides, set of 4 pcs. Chair height + 0,2 cm	2,75 g x 4		208
	<b>GRIP HOLE</b> Available for chairs without inside - and full upholstery			189

# FourCast® 2 Counter Four - Veneer

Design by Strand+Hvass

[Content ↗](#)

SURCHARGE		Price (SEK)
FRAME OPTIONAL	 <p>7 A D E F M N O Q S T</p>	194

# FourCast® 2 High Four

Design by Strand+Hvass

[Content ↗](#)



## FEATURES

- Fits table height 105 cm
- Stackable on floor
- Polyamide glides as standard
- Monochrome powder coating on frames options
- We do not recommend suspensions to fully upholstered version



For product information visit [oceefour.com](https://oceefour.com) ↗

## SHELL COLOURS

Standard Polypropylene



## FRAME COLOURS

Standard



Optional Polypropylene

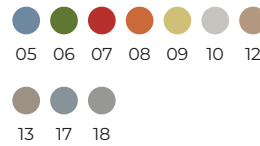

Frame optional\*





For full colour details [go to page 236](#) ↗

Product	Description (Item nr)	Weight (Kg)	Stacking on floor	Dimensions (mm)	Band	Standard PP (SEK)	Optional PP (SEK)
	<b>34100</b> FourCast® 2 High Four, Polypropylene shell	6.7	4		-	3.492	3.683
	<b>34110</b> FourCast® 2 High Four, Seat pad	7.7	4		1 2 3 4 5 6 7 8 10	4.754 4.849 4.944 5.038 5.130 5.226 5.321 5.415 5.633	4.945 5.040 5.135 5.229 5.321 5.417 5.512 5.606 5.824
	<b>34130</b> FourCast® 2 High Four, Fully upholstered	7.2	4		1 2 3 4 5 6 7 8 10	6.201 6.422 6.645 6.865 7.084 7.305 7.527 7.746 8.232	

# FourCast® 2 High Four

Design by Strand+Hvass

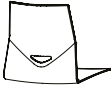
[Content ↗](#)

ACCESSORIES	Description	Weight (Kg)	Dimensions (mm)	Price (SEK)
	<b>CHAIR FEET</b> Felt glides, set of 4 pcs. height + 0,2 cm	1,82 g x 4		208
	<b>CHAIR FEET</b> Teflon glides, set of 4 pcs. Chair height + 0,2 cm	2,75 g x 4		208
	<b>GRIP HOLE</b> Available for chairs without inside – and full upholstery			189
SURCHARGE				Price (SEK)
<b>FRAME OPTIONAL</b>	 7 A D E F M N O Q S T			194

# FourCast® 2 High Four - Veneer

Design by Strand+Hvass

[Content](#) ↗



## FEATURES

- Fits table height 105 cm
- Stackable on floor
- Polyamide glides as standard
- Monochrome powder coating on frames options
- We do not recommend suspensions to black lacquered versions

For product information visit [oceefour.com](https://oceefour.com) ↗

## SHELL COLOURS

Veneer



## FRAME COLOURS

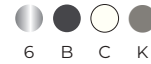

Standard



Frame optional\*

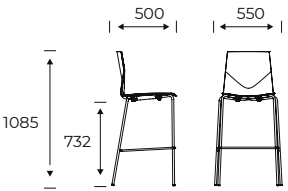

For full colour details [go to page 236](#) ↗

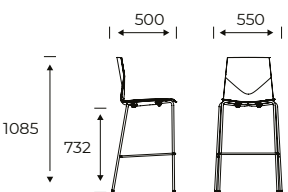
Product	Description (Item nr)	Weight (Kg)	Stacking on floor	Dimensions (mm)	Band	Veneer (SEK)
	<b>34140</b> FourCast® 2 High Four, Wooden shell	7.4	4		-	4.414
	<b>34150</b> FourCast® 2 High Four, Seat pad, wooden shell	8.8	4		1 2 3 4 5 6 7 8 10	5.676 5.771 5.866 5.960 6.052 6.148 6.243 6.337 6.555

ACCESSORIES	Description	Weight (Kg)	Dimensions (mm)	Price (SEK)
	<b>CHAIR FEET</b> Felt glides, set of 4 pcs. height + 0,2 cm	1,82 g x 4		208
	<b>CHAIR FEET</b> Teflon glides, set of 4 pcs. Chair height + 0,2 cm	2,75 g x 4		208
	<b>GRIP HOLE</b> Available for chairs without inside - and full upholstery			189

# FourCast® 2 High Four - Veneer

Design by Strand+Hvass

[Content ↗](#)

SURCHARGE		Price (SEK)
FRAME OPTIONAL	 <p>7 A D E F M N O Q S T</p>	194

# FourCast® 2 Wheeler

Design by Strand+Hvass

[Content ↗](#)



## FEATURES

- Inno® Tab, flexible and rotating writing tablet options
- Gas lift, 41 - 57,5 cm
- Free Float options
- Black base with castors as standard
- Aluminium base options
- We do not recommend suspensions to fully upholstered version



For product information visit [oceefour.com](https://oceefour.com) ↗

## SHELL COLOURS

Standard Polypropylene



Optional Polypropylene

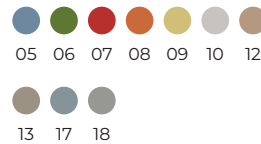

## FRAME COLOURS

Standard



Frame optional\*



For full colour details [go to page 236](#) ↗









Product	Description (Item nr)	Weight (Kg)	Dimensions (mm)	Band	Standard PP (SEK)	Optional PP (SEK)
	<b>35004</b> FourCast® 2 Wheeler, Polypropylene shell, Without tilt with gas	7.3		-	3.016	3.207
	<b>35014</b> FourCast® 2 Wheeler, Seat pad, Without tilt with gas	7.9		1 2 3 4 5 6 7 8 10	4.278 4.373 4.468 4.562 4.654 4.750 4.845 4.939 5.157	4.469 4.564 4.659 4.753 4.845 4.941 5.036 5.130 5.348
	<b>35034</b> FourCast® 2 Wheeler, Fully upholstered, Without tilt with gas	6.2		1 2 3 4 5 6 7 8 10	5.725 5.946 6.169 6.389 6.608 6.829 7.051 7.270 7.756	
	<b>35005</b> FourCast® 2 Wheeler, Polypropylene shell, With tilt with gas	7.3		-	3.380	3.571

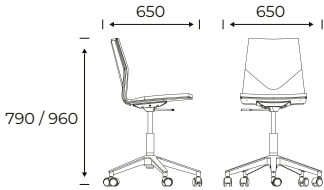

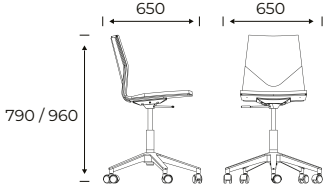
# FourCast® 2 Wheeler

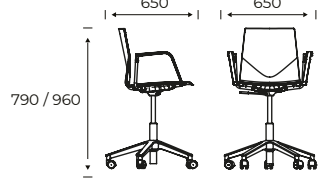
Design by Strand+Hvass

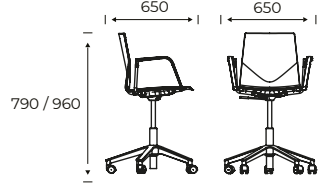

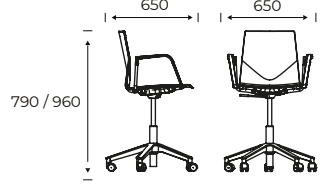

[Content ↗](#)

Product	Description (Item nr)	Weight (Kg)	Dimensions (mm)	Band	Standard PP (SEK)	Optional PP (SEK)
	<b>35015</b> FourCast® 2 Wheeler, Seat pad, With tilt with gas	7.9		1 2 3 4 5 6 7 8 10	4.642 4.737 4.832 4.926 5.018 5.114 5.209 5.303 5.521	4.833 4.928 5.023 5.117 5.209 5.305 5.400 5.494 5.712
	<b>35035</b> FourCast® 2 Wheeler, Fully upholstered, With tilt with gas	6.2		1 2 3 4 5 6 7 8 10	6.089 6.310 6.533 6.753 6.972 7.193 7.415 7.634 8.120	
	<b>34905</b> FourCast® 2 Wheeler with Loop Armrests, Polypropylene shell, With tilt with gas	8.5		-	4.524	4.715
	<b>34915</b> FourCast® 2 Wheeler with Loop Armrests, Seat pad, With tilt with gas	9.1		1 2 3 4 5 6 7 8 10	5.786 5.881 5.976 6.070 6.162 6.258 6.353 6.447 6.665	5.977 6.072 6.167 6.261 6.353 6.449 6.544 6.638 6.856
	<b>34935</b> FourCast® 2 Wheeler with Loop Armrests, Fully upholstered, With tilt with gas	7.4		1 2 3 4 5 6 7 8 10	7.233 7.454 7.677 7.897 8.116 8.337 8.559 8.778 9.264	

# FourCast® 2 Wheeler

Design by Strand+Hvass

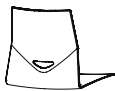
[Content ↗](#)

ACCESSORIES	Description	Weight (Kg)	Dimensions (mm)	Price (SEK)
	<b>HOOK</b> Hook in black			47
	<b>CHAIR FEET</b> Standard polymide glides. Chair height + 0,2 cm			
	<b>CHAIR FEET</b> Castor with breaks, hard			599
	<b>FOOTRING</b> Gas lift including footring Spand 41 cm. - 57,5 cm.		585 - 845 mm	1.368
	<b>GRIP HOLE</b> Available for chairs without inside - and full upholstery			189
	With GS certification			1.489
	<b>INNO</b> Foldable Inno® Tab in black with integrated cup holder and dashboard for tablet and phone.	2,7 KG	520 x 320 x 23 mm	2.125
SURCHARGE				Price (SEK)
<b>FRAME OPTIONAL</b>	 4			643

# FourCast® 2 77

Design by Strand+Hvass

[Content ↗](#)



## FEATURES

- Armrest options
- Stackable on floor
- Monochrome powder coating on frames options
- We do not recommend suspensions for fully upholstered version



For product information visit [oceefour.com](http://oceefour.com) ↗

## SHELL COLOURS

Standard Polypropylene



## FRAME COLOURS

Standard

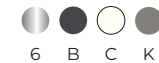

Optional Polypropylene

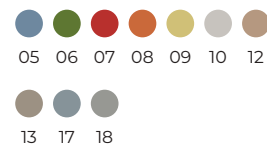

Frame optional\*





For full colour details [go to page 236](#) ↗

Product	Description (Item nr)	Weight (Kg)	Stacking on floor	Dimensions (mm)	Band	Standard PP (SEK)	Optional PP (SEK)
	<b>32800</b> FourCast® 2 77, Polypropylene shell	5.8	7		-	2.734	2.925
	<b>32810</b> FourCast® 2 77, Seat pad	6.8	5		1 2 3 4 5 6 7 8 10	3.996 4.091 4.186 4.280 4.372 4.468 4.563 4.657 4.875	4.187 4.282 4.377 4.471 4.563 4.659 4.754 4.848 5.066
	<b>32830</b> FourCast® 2 77, Fully upholstered	5.1	5		1 2 3 4 5 6 7 8 10	5.443 5.664 5.887 6.107 6.326 6.547 6.769 6.988 7.474	
	<b>32900</b> FourCast® 2 77 with Armrests, Polypropylene shell	6.4	7		-	3.888	4.079

# FourCast® 2 77

Design by Strand+Hvass

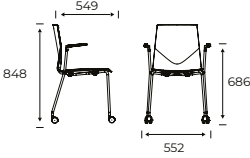
[Content ↗](#)

Product	Description (Item nr)	Weight (Kg)	Stacking on floor	Dimensions (mm)	Band	Standard PP (SEK)	Optional PP (SEK)
	<b>32910</b> FourCast® 2 77 with Armrests, Seat pad	7.4	5		1	5.150	5.341
					2	5.245	5.436
					3	5.340	5.531
					4	5.434	5.625
					5	5.526	5.717
					6	5.622	5.813
					7	5.717	5.908
					8	5.811	6.002
					10	6.029	6.220
						<b>32930</b> FourCast® 2 77 with Armrests, Fully upholstered	5.8
2	6.818						
3	7.041						
4	7.261						
5	7.480						
6	7.701						
7	7.923						
8	8.142						
10	8.628						

ACCESSORIES	Description	Weight (Kg)	Dimensions (mm)	Price (SEK)
	<b>GRIP HOLE</b> Available for chairs without inside – and full upholstery			189

SURCHARGE		Price (SEK)
<b>FRAME OPTIONAL</b> 		194

# FourCast® 2 77 - Veneer

Design by Strand+Hvass

[Content ↗](#)



## FEATURES

- Armrest options
- Stackable on floor
- Monochrome powder coating on frames options
- We do not recommend suspensions to black lacquered versions



For product information visit [oceefour.com](https://oceefour.com) ↗

## SHELL COLOURS

Veneer



## FRAME COLOURS



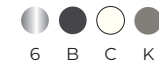



Standard

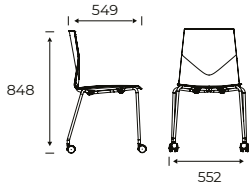

Frame optional\*

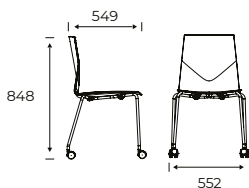

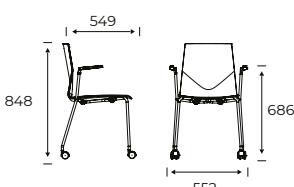
For full colour details [go to page 236](#) ↗

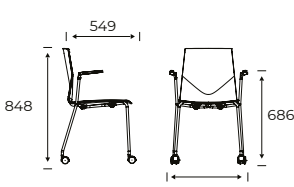
Product	Description (Item nr)	Weight (Kg)	Stacking on floor	Dimensions (mm)	Band	Veneer (SEK)
	<b>32840</b> FourCast® 2 77, Wooden shell	4.4	-		-	3.656
	<b>32850</b> FourCast® 2 77, Seat pad, wooden shell	5.8	5		1 2 3 4 5 6 7 8 10	4.918 5.013 5.108 5.202 5.294 5.390 5.485 5.579 5.797
	<b>32940</b> FourCast® 2 77 with Armrests, Wooden shell	5	7		-	4.810
	<b>32950</b> FourCast® 2 77 with Armrests, Seat pad, wooden shell	6.4	5		1 2 3 4 5 6 7 8 10	6.072 6.167 6.262 6.356 6.448 6.544 6.639 6.733 6.951

# FourCast® 2 77 - Veneer

Design by Strand+Hvass

[Content ↗](#)

ACCESSORIES	Description	Weight (Kg)	Dimensions (mm)	Price (SEK)
	<b>GRIP HOLE</b> Available for chairs without inside – and full upholstery			189
SURCHARGE				Price (SEK)
<b>FRAME OPTIONAL</b>	 7 A D E F M N O Q S T			194

# FourCast® 2 One

Design by Strand+Hvass

[Content ↗](#)



## FEATURES

- Armrest options
- Swivel with freefloat in seat/back
- Return mechanism options
- Polyamide glides as standard
- Teflon or felt glides options
- Soft castor options (fixed cone without swivel and return)
- Monochrome powder coating on frames options
- We do not recommend suspensions to fully upholstered version



For product information visit [oceefour.com](https://oceefour.com) ↗

## SHELL COLOURS

Standard Polypropylene



## FRAME COLOURS

Standard

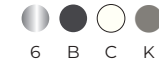

Optional Polypropylene

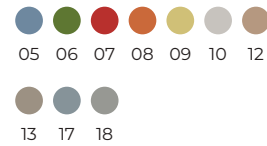











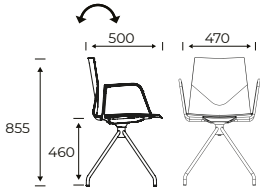

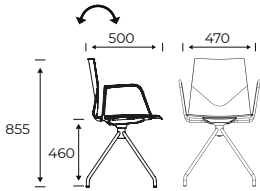

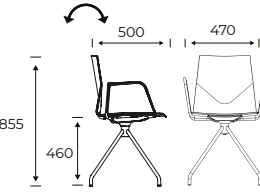
For full colour details [go to page 236](#) ↗

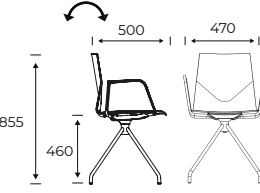
Product	Description (Item nr)	Weight (Kg)	Dimensions (mm)	Band	Standard PP (SEK)	Optional PP (SEK)
	<b>33001</b> FourCast® 2 One, Polypropylene shell, With tilt	6.2		-	3.798	3.989
	<b>33003</b> FourCast® 2 One, Polypropylene shell, With tilt with return	-		-	4.971	5.162
	<b>33011</b> FourCast® 2 One, Seat pad, With tilt	6.8		1 2 3 4 5 6 7 8 10	5.060 5.155 5.250 5.344 5.436 5.532 5.627 5.721 5.939	5.251 5.346 5.441 5.535 5.627 5.723 5.818 5.912 6.130
	<b>33013</b> FourCast® 2 One, Seat pad, With tilt with return	7		1 2 3 4 5 6 7 8 10	6.233 6.328 6.423 6.517 6.609 6.705 6.800 6.894 7.112	6.424 6.519 6.614 6.708 6.800 6.896 6.991 7.085 7.303

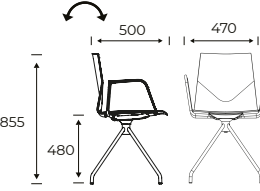

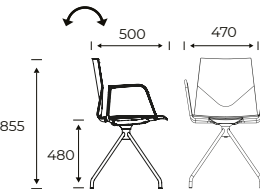
# FourCast® 2 One

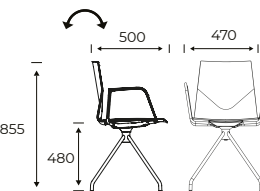
Design by Strand+Hvass

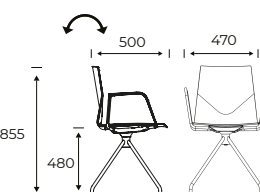
[Content ↗](#)

Product	Description (Item nr)	Weight (Kg)	Dimensions (mm)	Band	Standard PP (SEK)	Optional PP (SEK)
	<b>33031</b> FourCast® 2 One, Fully upholstered, With tilt	5.1		1 2 3 4 5 6 7 8 10	6.507 6.728 6.951 7.171 7.390 7.611 7.833 8.052 8.538	
	<b>33033</b> FourCast® 2 One, Fully upholstered, With tilt with return	5.3		1 2 3 4 5 6 7 8 10	7.680 7.901 8.124 8.344 8.563 8.784 9.006 9.225 9.711	
	<b>33101</b> FourCast® 2 One with Loop Armrests, Polypropylene shell, With tilt	7.6		-	4.951	5.142
	<b>33103</b> FourCast® 2 One with Loop Armrests, Polypropylene shell, With tilt with return	-		-	6.124	6.315
	<b>33111</b> FourCast® 2 One with Loop Armrests, Seat pad, With tilt	7.9		1 2 3 4 5 6 7 8 10	6.213 6.308 6.403 6.497 6.589 6.685 6.780 6.874 7.092	6.404 6.499 6.594 6.688 6.780 6.876 6.971 7.065 7.283
	<b>33113</b> FourCast® 2 One with Loop Armrests, Seat pad, With tilt with return	8.2		1 2 3 4 5 6 7 8 10	7.386 7.481 7.576 7.670 7.762 7.858 7.953 8.047 8.265	7.577 7.672 7.767 7.861 7.953 8.049 8.144 8.238 8.456
	<b>33131</b> FourCast® 2 One with Loop Armrests, Fully upholstered, With tilt	6.3		1 2 3 4 5 6 7 8 10	7.660 7.881 8.104 8.324 8.543 8.764 8.986 9.205 9.691	
	<b>33133</b> FourCast® 2 One with Loop Armrests, Fully upholstered, With tilt with return	6.5		1 2 3 4 5 6 7 8 10	8.833 9.054 9.277 9.497 9.716 9.937 10.159 10.378 10.864	

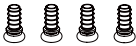

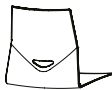
ACCESSORIES	Description	Weight (Kg)	Dimensions (mm)	Price (SEK)
	<b>CHAIR FEET</b> Castors			876
	<b>CHAIR FEET</b> Felt glides, set of 4 pcs. height + 0,2 cm	1,82 g x 4		208
	<b>CHAIR FEET</b> Set of 4 pcs. Noise reducing ferrule with big diameter (reduces pressure marks ) Chair height + 0,8 cm	4,8 g x 4		276
	<b>CHAIR FEET</b> Noise reducing ferrule with felt, set of 4 pcs. Chair height + 1 cm	6,6 g x 4		276
	<b>CHAIR FEET</b> Teflon glides, set of 4 pcs. Chair height + 0,2 cm	2,75 g x 4		208
	<b>GRIP HOLE</b> Available for chairs without inside – and full upholstery			189

# FourCast® 2 One - Veneer

Design by Strand+Hvass

[Content ↗](#)



## FEATURES

- Armrest options
- Swivel with freefloat in seat/back
- Return mechanism options
- Polyamide glides as standard
- Teflon or felt glides and soft castor options
- We do not recommend suspensions to black lacquered versions



For product information visit [oceefour.com](https://oceefour.com) ↗

## SHELL COLOURS

Veneer







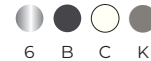

## FRAME COLOURS

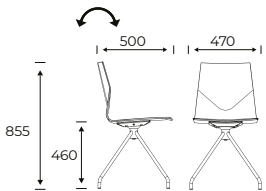
Standard

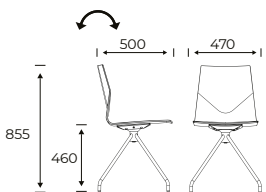

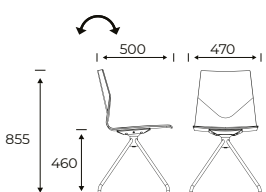

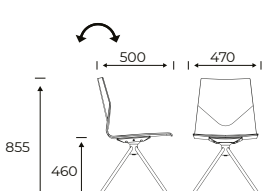



For full colour details [go to page 236](#) ↗

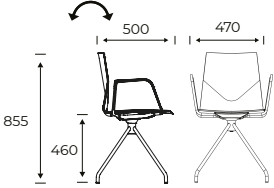

Product	Description (Item nr)	Weight (Kg)	Dimensions (mm)	Band	Veneer (SEK)	Optional PP (SEK)
	<b>33041</b> FourCast® 2 One, Wooden shell, With tilt	4.7		-	4.720	4.720
	<b>33043</b> FourCast® 2 One, Wooden shell, With tilt with return	5		-	5.893	5.893
	<b>33051</b> FourCast® 2 One, Seat pad, wooden shell, With tilt	5.8		1 2 3 4 5 6 7 8 10	5.982 6.077 6.172 6.266 6.358 6.454 6.549 6.643 6.861	5.982 6.077 6.172 6.266 6.358 6.454 6.549 6.643 6.861
	<b>33053</b> FourCast® 2 One, Seat pad, wooden shell, With tilt with return	5.9		1 2 3 4 5 6 7 8 10	7.155 7.250 7.345 7.439 7.531 7.627 7.722 7.816 8.034	7.155 7.250 7.345 7.439 7.531 7.627 7.722 7.816 8.034

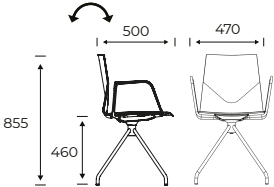
# FourCast® 2 One - Veneer

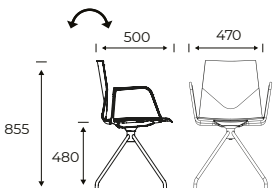
Design by Strand+Hvass

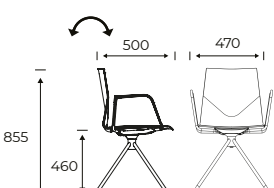
[Content ↗](#)

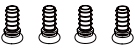
Product	Description (Item nr)	Weight (Kg)	Dimensions (mm)	Band	Veneer (SEK)	Optional PP (SEK)
	<b>33141</b> FourCast® 2 One with Loop Armrests, Wooden shell, With tilt	5.9		-	5.873	5.873
	<b>33143</b> FourCast® 2 One with Loop Armrests, Wooden shell, With tilt with return	6.1		-	7.046	7.046
	<b>33151</b> FourCast® 2 One with Loop Armrests, Seat pad, wooden shell, With tilt	6.9		1 2 3 4 5 6 7 8 10	7.135 7.230 7.325 7.419 7.511 7.607 7.702 7.796 8.014	7.135 7.230 7.325 7.419 7.511 7.607 7.702 7.796 8.014
	<b>33153</b> FourCast® 2 One with Loop Armrests, Seat pad, wooden shell, With tilt with return	7.1		1 2 3 4 5 6 7 8 10	8.308 8.403 8.498 8.592 8.684 8.780 8.875 8.969 9.187	8.308 8.403 8.498 8.592 8.684 8.780 8.875 8.969 9.187

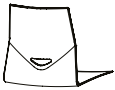
ACCESSORIES	Description	Weight (Kg)	Dimensions (mm)	Price (SEK)
	<b>CHAIR FEET</b> Castors			876
	<b>CHAIR FEET</b> Felt glides, set of 4 pcs. height + 0,2 cm	1,82 g x 4		208
	<b>CHAIR FEET</b> Set of 4 pcs. Noise reducing ferrule with big diameter (reduces pressure marks) Chair height + 0,8 cm	4,8 g x 4		276
	<b>CHAIR FEET</b> Noise reducing ferrule with felt, set of 4 pcs. Chair height + 1 cm	6,6 g x 4		276
	<b>CHAIR FEET</b> Teflon glides, set of 4 pcs. Chair height + 0,2 cm	2,75 g x 4		208
	<b>GRIP HOLE</b> Available for chairs without inside - and full upholstery			189



# FourCast® 2 Fire Retardant

Design by Strand+Hvass

[Content ↗](#)



## FEATURES

- Shell in Polypropylene
- Polyamide glides are standard
- Linking device optional for model 33200 only
- Stackable on matching trollies



For product information visit [oceefour.com](http://oceefour.com) ↗

## SHELL COLOURS

Standard Polypropylene



14







## FRAME COLOURS

Standard

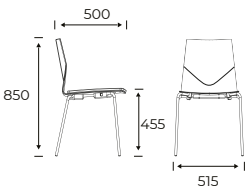

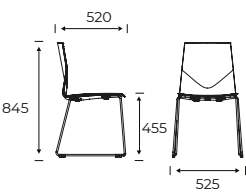
6 B C K 4

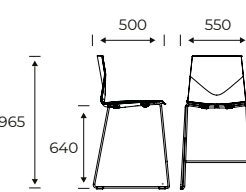
For full colour details [go to page 236](#) ↗

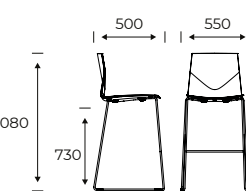







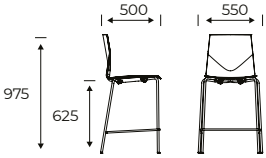

Product	Description (Item nr)	Weight (Kg)	Stacking on floor	Dimensions (mm)	Band	Standard PP (SEK)
	<b>32500</b> FourCast@ 2 Four, Polypropylene shell	4.8	-		-	2.944
	<b>33200</b> FourCast@ 2 Line, Polypropylene shell	5.7	-		-	3.430
	<b>33800</b> FourCast@ 2 Counter, Polypropylene shell	6.6	-		-	4.384
	<b>33900</b> FourCast@ 2 High, Polypropylene shell	7.3	-		-	4.469

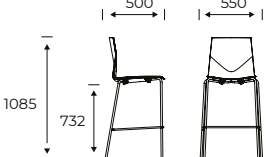

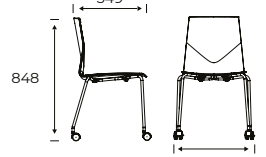
# FourCast® 2 Fire Retardant

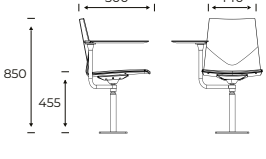
[Content ↗](#)

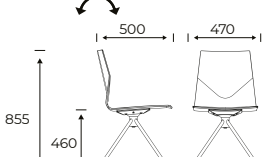





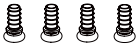

Design by Strand+Hvass

Product	Description (Item nr)	Weight (Kg)	Stacking on floor	Dimensions (mm)	Band	Standard PP (SEK)
	<b>34000</b> FourCast@ 2 Counter Four, Polypropylene shell	7.7	-		-	4.146
	<b>34100</b> FourCast@ 2 High Four, Polypropylene shell	6.7	-		-	4.146
	<b>32800</b> FourCast@ 2 77, Polypropylene shell	5.8	-		-	3.388
	<b>37001</b> FourCast@ 2 Audi, Polypropylene shell, With tilt	11.8	-		-	8.334
	<b>33001</b> FourCast@ 2 One, Polypropylene shell, With tilt	6.2	-		-	4.452
	<b>34503</b> FourCast@ 2 Evo, Polypropylene shell, With tilt with return	7	-		-	7.092

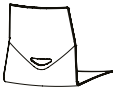
# FourCast® 2 Fire Retardant

Design by Strand+Hvass

[Content ↗](#)

ACCESSORIES	Description	Weight (Kg)	Dimensions (mm)	Price (SEK)
	<b>CHAIR FEET</b> Felt glides, set of 4 pcs. height + 0,2 cm	1,82 g x 4		208
	<b>CHAIR FEET</b> Set of 4 pcs. Noise reducing ferrule with big diameter (reduces pressure marks ) Chair height + 0,8 cm	4,8 g x 4		276
	<b>CHAIR FEET</b> Noise reducing ferrule with felt, set of 4 pcs. Chair height + 1 cm	6,6 g x 4		276
	<b>CHAIR FEET</b> Teflon glides, set of 4 pcs. Chair height + 0,2 cm	2,75 g x 4		208
	<b>LINKING DEVICE</b> Chair linking		C/C 540 mm C/C with armrest 540 mm	390
	<b>GRIP HOLE</b> Available for chairs without inside - and full upholstery			189
	<b>SEAT ROW NUMBER - ACSR0101</b> 16 mm - no. 1 -25	29 g		1.579
	<b>SEAT ROW NUMBER - ACSR0102</b> 16 mm - no. 26 -50	29 g		1.579
	<b>SEAT ROW NUMBER - ACSR0201</b> 11 mm - no. 1 -25	29 g		1.579
	<b>SEAT ROW NUMBER - ACSR0202</b> 11 mm - no. 26 -50	29 g		1.579
	<b>CHAIR TROLLEY - 200X0</b> 25 chairs without upholstery	33,5 Kg	1100 x 560 x 1970 mm	8.859
	<b>INNO@NOTE TROLLEY - 20100007</b> Trolley for Inno® Note. Room for 51 Inno® Notes.	58,5 Kg	1532 x 662 x 1199 mm	19.942

[page 325](#)







## FEATURES

- Wooden legs options\*
- Polyamide glides as standard
- Powder coated frame options
- \*Round oak oiled nature: not available. Black oiled legs: Limited stock available.\*



For product information visit [oceefour.com](https://oceefour.com) ↗

## SHELL COLOURS

Standard Polypropylene



## FRAME COLOURS







Standard



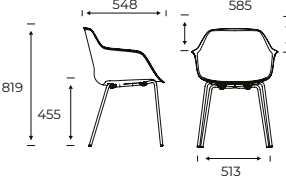

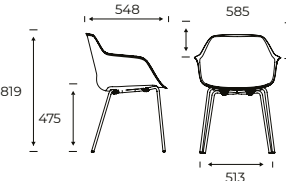

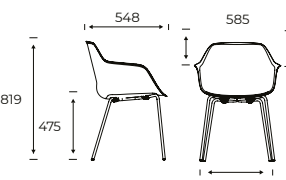

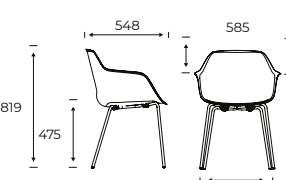

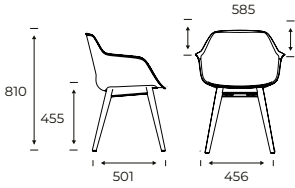

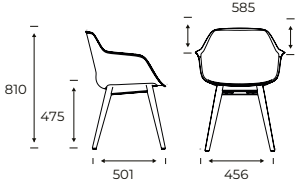

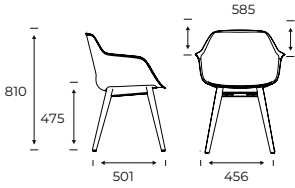

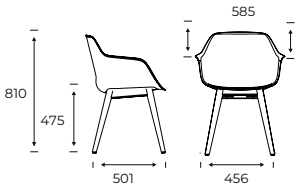

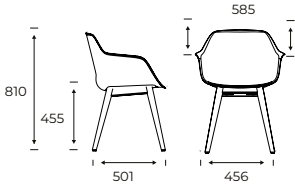
Frame optional\*

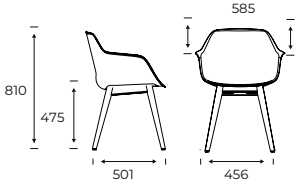

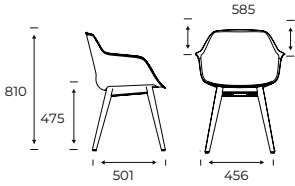
For full colour details [go to page 236](#) ↗

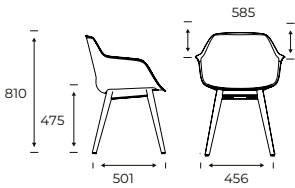
Product	Description (Item nr)	Weight (Kg)	Dimensions (mm)	Band	Standard PP (SEK)
	<b>43000</b> FourMe® 44, Polypropylene shell	4.9		-	2.526
	<b>43010</b> FourMe® 44, Seat pad	5.7		1 2 3 4 5 6 7 8 10	3.788 3.883 3.978 4.072 4.164 4.260 4.355 4.449 4.667
	<b>43020</b> FourMe® 44, Inside upholstery	5.3		1 2 3 4 5 6 7 8 10	5.214 5.563 5.910 6.259 6.609 6.958 7.306 7.653 8.351
	<b>43030</b> FourMe® 44, Fully upholstered	5.4		1 2 3 4 5 6 7 8 10	5.989 6.434 6.875 7.320 7.763 8.205 8.648 9.091 9.978

Product	Description (Item nr)	Weight (Kg)	Dimensions (mm)	Band	Standard PP (SEK)
	<b>43000*</b> FourMe® 44, Polypropylene shell, Oak oil, nature	4.9		-	3.778
	<b>43010*</b> FourMe® 44, Seat pad, Oak oil, nature	5.7		1 2 3 4 5 6 7 8 10	5.040 5.135 5.230 5.324 5.416 5.512 5.607 5.701 5.919
	<b>43020*</b> FourMe® 44, Inside upholstery, Oak oil, nature	5.3		1 2 3 4 5 6 7 8 10	6.466 6.815 7.162 7.511 7.861 8.210 8.558 8.905 9.603
	<b>43030*</b> FourMe® 44, Fully upholstered, Oak oil, nature	5.4		1 2 3 4 5 6 7 8 10	7.241 7.686 8.127 8.572 9.015 9.457 9.900 10.343 11.230
	<b>43000</b> FourMe® 44, Polypropylene shell, Oak lacquered	4.9		-	4.149
	<b>43010</b> FourMe® 44, Seat pad, Oak lacquered	5.7		1 2 3 4 5 6 7 8 10	5.411 5.506 5.601 5.695 5.787 5.883 5.978 6.072 6.290
	<b>43020</b> FourMe® 44, Inside upholstery, Oak lacquered	5.3		1 2 3 4 5 6 7 8 10	6.837 7.186 7.533 7.882 8.232 8.581 8.929 9.276 9.974
	<b>43030</b> FourMe® 44, Fully upholstered, Oak lacquered	5.4		1 2 3 4 5 6 7 8 10	7.612 8.057 8.498 8.943 9.386 9.828 10.271 10.714 11.601

Product	Description (Item nr)	Weight (Kg)	Dimensions (mm)	Band	Standard PP (SEK)
	<b>4904</b> Loose seat pad (Only available for chairs without upholstery)	4.1		1	1.465
				2	1.561
				3	1.657
				4	1.753
				5	1.851
				6	1.947
				7	2.042
				8	2.138
				10	2.360

ACCESSORIES	Description	Weight (Kg)	Dimensions (mm)	Price (SEK)
	<b>CHAIR FEET</b> Felt glides, set of 4 pcs. height + 0,2 cm	1,82 g x 4		208
	<b>CHAIR FEET</b> Set of 4 pcs. Noise reducing ferrule with big diameter (reduces pressure marks ) Chair height + 0,8 cm	4,8 g x 4		276
	<b>CHAIR FEET</b> Noise reducing ferrule with felt, set of 4 pcs. Chair height + 1 cm	6,6 g x 4		276
	<b>CHAIR FEET</b> Teflon glides, set of 4 pcs. Chair height + 0,2 cm	2,75 g x 4		208

SURCHARGE		Price (SEK)
<b>FRAME OPTIONAL</b>	● P	443
	● V	446



## FEATURES

- Polyamide glides as standard
- Powder coated frame options

For product information visit [oceefour.com](https://oceefour.com) ↗

## SHELL COLOURS

Standard Polypropylene



## FRAME COLOURS

Standard

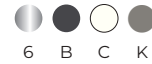

For full colour details [go to page 236](#) ↗

Product	Description (Item nr)	Weight (Kg)	Dimensions (mm)	Band	Standard PP (SEK)
	<b>43200</b> FourMe® 88, Polypropylene shell	5,9		-	2.982
	<b>43210</b> FourMe® 88, Seat pad	6,7		1 2 3 4 5 6 7 8 10	4.244 4.339 4.434 4.528 4.620 4.716 4.811 4.905 5.123
	<b>43220</b> FourMe® 88, Inside upholstery	6,3		1 2 3 4 5 6 7 8 10	5.670 6.019 6.366 6.715 7.065 7.414 7.762 8.109 8.807
	<b>43230</b> FourMe® 88, Fully upholstered	6,4		1 2 3 4 5 6 7 8 10	6.445 6.890 7.331 7.776 8.219 8.661 9.104 9.547 10.434

Product	Description (Item nr)	Weight (Kg)	Dimensions (mm)	Band	Standard PP (SEK)
	<b>4904</b> Loose seat pad (Only available for chairs without upholstery)	4.1		1	1.465
				2	1.561
				3	1.657
				4	1.753
				5	1.851
				6	1.947
				7	2.042
				8	2.138
				10	2.360

ACCESSORIES	Description	Weight (Kg)	Dimensions (mm)	Price (SEK)
	<b>CHAIR FEET</b> Felt glides, set of 4 pcs. height + 0,2 cm	1,82 g x 4		208
	<b>CHAIR FEET</b> Teflon glides, set of 4 pcs. Chair height + 0,2 cm	2,75 g x 4		208



## FEATURES

- Inno® Tab, flexible and rotating writing tablet
- Gas lift, 41-57,5 cm
- Black base with castors as standard
- Aluminium base options

For product information visit [oceefour.com](http://oceefour.com) ↗

## SHELL COLOURS

Standard Polypropylene



## FRAME COLOURS

Standard









Frame optional\*

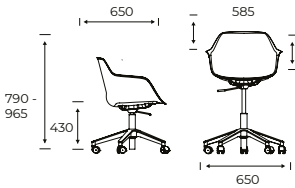

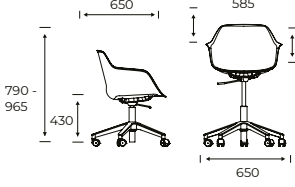
For full colour details [go to page 236](#) ↗

Product	Description (Item nr)	Weight (Kg)	Dimensions (mm)	Band	Standard PP (SEK)
	<b>43404</b> FourMe® 66, Polypropylene shell, Without tilt with gas	7.5		-	3.283
	<b>43405</b> FourMe® 66, Polypropylene shell, With tilt with gas	7.5		-	3.647
	<b>43414</b> FourMe® 66, Seat pad, Without tilt with gas	8.4		1 2 3 4 5 6 7 8 10	4.545 4.640 4.735 4.829 4.921 5.017 5.112 5.206 5.424
	<b>43415</b> FourMe® 66, Seat pad, With tilt with gas	8.4		1 2 3 4 5 6 7 8 10	4.909 5.004 5.099 5.193 5.285 5.381 5.476 5.570 5.788

Product	Description (Item nr)	Weight (Kg)	Dimensions (mm)	Band	Standard PP (SEK)
	<b>43424</b> FourMe® 66, Inside upholstery, Without tilt with gas	7.9		1	5.971
				2	6.320
				3	6.667
				4	7.016
				5	7.366
				6	7.715
				7	8.063
				8	8.410
				10	9.108
					<b>43425</b> FourMe® 66, Inside upholstery, With tilt with gas
2	6.684				
3	7.031				
4	7.380				
5	7.730				
6	8.079				
7	8.427				
8	8.774				
10	9.472				
	<b>43434</b> FourMe® 66, Fully upholstered, Without tilt with gas	8.1			
				2	7.191
				3	7.632
				4	8.077
				5	8.520
				6	8.962
				7	9.405
				8	9.848
				10	10.735
					<b>43435</b> FourMe® 66, Fully upholstered, With tilt with gas
2	7.555				
3	7.996				
4	8.441				
5	8.884				
6	9.326				
7	9.769				
8	10.212				
10	11.099				
	<b>4904</b> Loose seat pad (Only available for chairs without upholstery)	4.1			
				2	1.561
				3	1.657
				4	1.753
				5	1.851
				6	1.947
				7	2.042
				8	2.138
				10	2.360

ACCESSORIES	Description	Weight (Kg)	Dimensions (mm)	Price (SEK)
	<b>FOOTRING</b> Gas lift including footring Spand 41 cm. - 57,5 cm.		585 - 845 mm	1.368
	With GS certification			1.489
	<b>CHAIR FEET</b> Castor with breaks, hard			599
	<b>INNO</b> Foldable Inno® Tab in black with integrated cup holder and dashboard for tablet and phone.	2,7 KG	520 x 320 x 23 mm	2.125

SURCHARGE		Price (SEK)
<b>FRAME OPTIONAL</b>	 4	643







# Share Basic

Design by Strand+Hvass

[Content ↗](#)



## FEATURES



- Take a more informal seat, Share allows you to sit however you feel comfortable – even back to front!
- Customise your chair with a range of standard materials, finishes and colours to choose from
- The following versions SH1, SH2 & SH01 of Share Basic are ecolabeled. This certification applies to all colours and finishes.
- Designed for disassembly – replace parts with ease, including upholstered seat covers.
- Inno®Note tablet options
- Frame available in black, stone grey or white
- Visible fasteners will match the frame colour
- Back cover available in a range of colours
- Curved ledge on the back rest is only available for Polypropylene
- Noise reducing glides
- Stacking protection in black under seat

For product information visit [oceefour.com](http://oceefour.com) ↗

### SEAT / BACK COLOURS

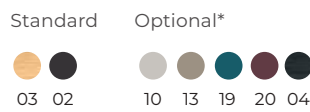



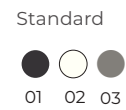

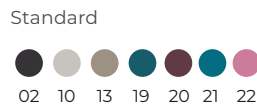

### FRAME COLOURS

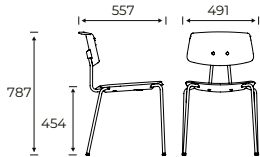

### BACK COVER COLOURS

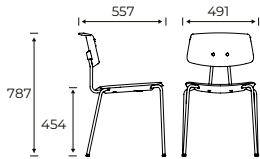

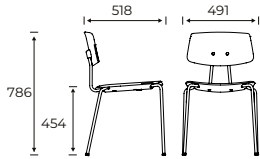
For full colour details [go to page 236](#) ↗

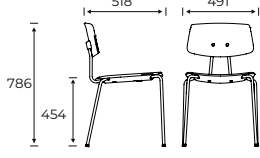



Product	Description (Item nr)	Weight (Kg)	Stacking on floor	Dimensions (mm)	Band	Price (SEK)
	<b>SH1</b> Share Basic, Polypropylene	5	12		-	2.387
	<b>SH03</b> Polypropylene Back, Upholstered Seat	5	10		1 2 3 4 5 6 7 8 10	2.810 3.007 3.204 3.401 3.599 3.796 3.993 4.190 4.387
	<b>SH2</b> Share Basic, Veneer	4.6	12		-	3.232
	<b>SH04</b> Share Basic, Veneer Back, Upholstered Seat	4.8	10		1 2 3 4 5 6 7 8 10	3.655 3.852 4.049 4.246 4.444 4.641 4.838 5.035 5.232

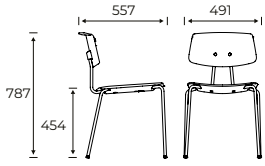

# Share Basic

Design by Strand+Hvass

[Content ↗](#)

Product	Description (Item nr)	Weight (Kg)	Stacking on floor	Dimensions (mm)	Band	Price (SEK)
	<b>SH01</b> Share Basic, Polypropylene Back, Veneer Seat	4.8	12		-	2.951

ACCESSORIES	Description	Weight (Kg)	Dimensions (mm)	Price (SEK)
	<b>INNO</b> Inno® Note in black, removable and foldable. Not available for chairs with Loop armrest and chairs with wooden legs.	1,4 KG	225 x 325 x 10 mm	1.522
	<b>INNO@NOTE TROLLEY - 20100007</b> Trolley for Inno® Note. Room for 51 Inno® Notes.	58,5 Kg	1532 x 662 x 1199 mm	19.942
	<b>SEAT ROW NUMBER - ACSR0101</b> 16 mm - no. 1 -25	29 g		1.579
	<b>SEAT ROW NUMBER - ACSR0102</b> 16 mm - no. 26 -50	29 g		1.579
	<b>CHAIR TROLLEY - 200X0</b> 28 chairs with seat pad or 20 chairs with full upholstery	33,5 Kg	1100 x 560 x 1910 / 1980 mm	10.373

SURCHARGE		Price (SEK)
<b>PP SEAT / BACK OPTIONAL</b>		141
<b>VENEER SEAT / BACK OPTIONAL</b>		141

# Share Stool with Steel Legs

Design by Strand+Hvass

[Content](#) ↗



## FEATURES

- Take a more informal seat, the Share Stool allows you to sit however you feel comfortable
- Boost comfort with upholstered seat pad or fully upholstered seat option
- Visible fasteners will match the colour of the steel legs
- Option to have seat in black lacquered oak
- PE glides are standard
- Available in 3 heights
- We do not recommend suspensions to fully upholstered and black lacquered versions
- \*Share Stools with wooden shell without visible fasteners: Limited stock available



For product information visit [oceefour.com](https://oceefour.com) ↗

## SHELL COLOURS

Veneer



03

## FRAME COLOURS

Standard









01 02 03

Optional Seat

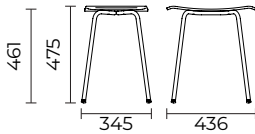

04

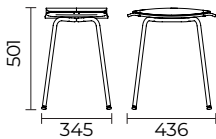
For full colour details [go to page 236](#) ↗

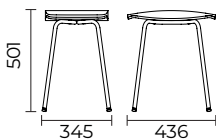
Product	Description (Item nr)	Weight (Kg)	Dimensions (mm)	Band	Veneer (SEK)	Optional veneer (SEK)
	<b>SHF15</b> Share Stool with Steel Legs, Wooden shell with visible fasteners, Tableheight 74	2.4		-	2.094	2.539
	<b>64040*</b> Share Stool with Steel Legs, Wooden shell, Tableheight 74	2.4		-	2.094	2.539
	<b>SHF16</b> Share Stool with Steel Legs, Seat pad, wooden shell, Tableheight 74	2.7		1 2 3 4 5 6 7 8 10	2.980 3.073 3.167 3.259 3.351 3.443 3.538 3.630 3.730	3.425 3.518 3.612 3.704 3.796 3.888 3.983 4.075 4.175
	<b>SHF14</b> Share Stool with Steel Legs, Fully upholstered, Tableheight 74	2.6		1 2 3 4 5 6 7 8 10	3.341 3.434 3.526 3.619 3.714 3.807 3.899 3.993 4.208	

# Share Stool with Steel Legs

[Content ↗](#)

Design by Strand+Hvass

Product	Description (Item nr)	Weight (Kg)	Dimensions (mm)	Band	Veneer (SEK)	Optional veneer (SEK)
	<b>SHF25</b> Share Stool with Steel Legs, Wooden shell with visible fasteners, Tableheight 90	4		-	2.498	2.943
	<b>64041*</b> Share Stool with Steel Legs, Wooden shell, Tableheight 90	4		-	2.498	2.943
	<b>SHF26</b> Share Stool with Steel Legs, Seat pad, wooden shell, Tableheight 90	4.3		1 2 3 4 5 6 7 8 10	3.527 3.621 3.710 3.810 3.900 3.994 4.086 4.179 4.398	3.972 4.066 4.155 4.255 4.345 4.439 4.531 4.624 4.843
	<b>SHF24</b> Share Stool with Steel Legs, Fully upholstered, Tableheight 90	4.1		1 2 3 4 5 6 7 8 10	3.890 3.984 4.077 4.169 4.263 4.355 4.448 4.542 4.759	
	<b>SHF35</b> Share Stool with Steel Legs, Wooden shell with visible fasteners, Tableheight 105	4.3		-	2.892	3.337
	<b>64042*</b> Share Stool with Steel Legs, Wooden shell, Tableheight 105	4.3		-	2.892	3.337
	<b>SHF36</b> Share Stool with Steel Legs, Seat pad, wooden shell, Tableheight 105	4.6		1 2 3 4 5 6 7 8 10	4.071 4.165 4.258 4.350 4.443 4.537 4.630 4.723 4.940	4.516 4.610 4.703 4.795 4.888 4.982 5.075 5.168 5.385
	<b>SHF34</b> Share Stool with Steel Legs, Fully upholstered, Tableheight 105	4.5		1 2 3 4 5 6 7 8 10	4.434 4.525 4.620 4.712 4.807 4.897 4.991 5.085 5.300	

ACCESSORIES	Description	Weight (Kg)	Dimensions (mm)	Price (SEK)
	<b>CHAIR FEET</b> Felt glides, set of 4 pcs. height + 0,2 cm	1,82 g x 4		208

# Share Stool with Wooden Legs

Design by Strand+Hvass

[Content ↗](#)



## FEATURES

- Take a more informal seat, the Share Stool allows you to sit however you feel comfortable
- Boost comfort with upholstered seat pad or fully upholstered seat option
- Visible fasteners are available in black, grey and white
- Option to have seat in black lacquered oak
- Frame in black lacquered oak options
- PE glides are standard
- Available in 3 heights
- We do not recommend suspensions to fully upholstered and black lacquered versions
- \*Share Stools with wooden shell without visible fasteners: Limited stock available



For product information visit [oceefour.com](https://oceefour.com) ↗

## SHELL COLOURS

Veneer



Optional Seat



## FRAME COLOURS







Standard

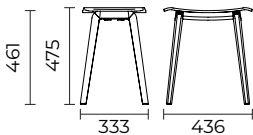

Frame optional\*

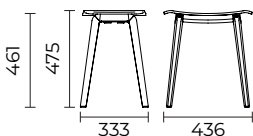

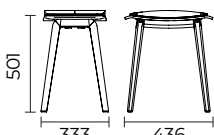

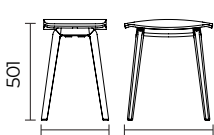







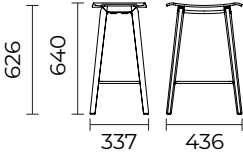

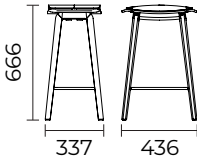

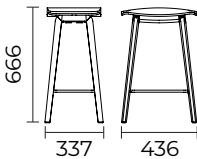
For full colour details [go to page 236](#) ↗

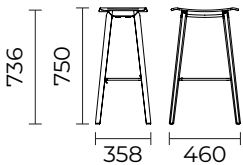
Product	Description (Item nr)	Weight (Kg)	Dimensions (mm)	Band	Veneer (SEK)	Optional veneer (SEK)
	<b>SHG15</b> Share Stool with Wooden Legs, Wooden shell with visible fasteners, Tableheight 74	2.1		-	3.478	3.923
	<b>63640*</b> Share Stool with Wooden Legs, Wooden shell, Tableheight 74	2.1		-	3.478	3.923
	<b>SHG16</b> Share Stool with Wooden Legs, Seat pad, wooden shell, Tableheight 74	2.4		1 2 3 4 5 6 7 8 10	4.614 4.704 4.793 4.882 4.973 5.062 5.151 5.241 5.450	5.059 5.149 5.238 5.327 5.418 5.507 5.596 5.686 5.895
	<b>SHG14</b> Share Stool with Wooden Legs, Fully upholstered, Tableheight 74	2.3		1 2 3 4 5 6 7 8 10	4.963 5.052 5.141 5.232 5.320 5.410 5.501 5.589 5.799	

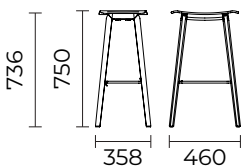
# Share Stool with Wooden Legs

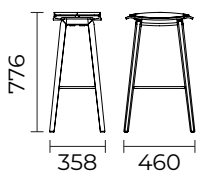

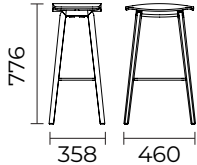
Design by Strand+Hvass

Product	Description (Item nr)	Weight (Kg)	Dimensions (mm)	Band	Veneer (SEK)	Optional veneer (SEK)
	<b>SHG25</b> Share Stool with Wooden Legs, Wooden shell with visible fastners, Tableheight 90	3.5		-	4.872	5.317
	<b>63641*</b> Share Stool with Wooden Legs, Wooden shell, Tableheight 90	3.5		-	4.872	5.317
	<b>SHG26</b> Share Stool with Wooden Legs, Seat pad, wooden shell, Tableheight 90	3.8		1 2 3 4 5 6 7 8 10	6.008 6.098 6.186 6.276 6.366 6.456 6.544 6.635 6.844	6.453 6.543 6.631 6.721 6.811 6.901 6.989 7.080 7.289
	<b>SHG24</b> Share Stool with Wooden Legs, Fully upholstered, Tableheight 90	3.7		1 2 3 4 5 6 7 8 10	6.357 6.445 6.536 6.626 6.715 6.805 6.894 6.984 7.193	
	<b>SHG35</b> Share Stool with Wooden Legs, Wooden shell with visible fastners, Tableheight 105	3.8		-	4.899	5.344
	<b>63642*</b> Share Stool with Wooden Legs, Wooden shell, Tableheight 105	3.8		-	4.899	5.344
	<b>SHG36</b> Share Stool with Wooden Legs, Seat pad, wooden shell, Tableheight 105	4.1		1 2 3 4 5 6 7 8 10	6.035 6.124 6.214 6.303 6.394 6.482 6.572 6.662 6.871	6.480 6.569 6.659 6.748 6.839 6.927 7.017 7.107 7.316
	<b>SHG34</b> Share Stool with Wooden Legs, Fully upholstered, Tableheight 105	3.9		1 2 3 4 5 6 7 8 10	6.383 6.473 6.563 6.651 6.740 6.832 6.922 7.010 7.221	

# Share Stool with Wooden Legs

[Content ↗](#)

Design by Strand+Hvass

ACCESSORIES	Description	Weight (Kg)	Dimensions (mm)	Price (SEK)
	<b>FOOT REST COLOUR</b> Black matt standard Ral 7021			
	<b>FOOT REST COLOUR</b> White matt standard Ral 9010			
	<b>FOOT REST COLOUR</b> Stonegrey matt standard Ral 7039			

SURCHARGE		Price (SEK)
<b>FRAME OPTIONAL</b>	 V	445







# Share Bench with Steel Legs

Design by Strand+Hvass

[Content ↗](#)



## FEATURES

- Take a more informal seat, the Share Bench allows you to sit however you feel comfortable
- Boost comfort with upholstered seat pad or fully upholstered seat option
- Visible fasteners will match the colour of the steel legs
- Option to have seat in black lacquered oak
- PE glides are standard
- Available in 3 lengths
- We do not recommend suspensions to fully upholstered and black lacquered versions
- \*Share Bench with wooden shell without visible fasteners: Limited stock available



For product information visit [oceefour.com](https://oceefour.com) ↗

## SHELL COLOURS

Veneer



03

## FRAME COLOURS

Standard









01 02 03

Optional Seat

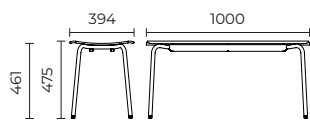

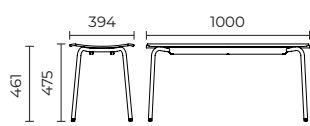
04

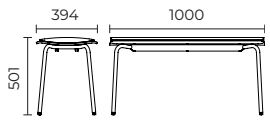

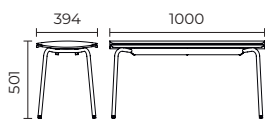







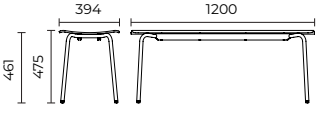

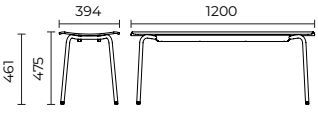

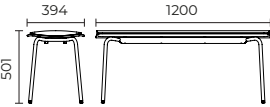
For full colour details [go to page 236](#) ↗

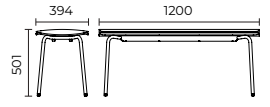
Product	Description (Item nr)	Weight (Kg)	Dimensions (mm)	Band	Veneer (SEK)	Optional veneer (SEK)
	<b>SHH15</b> Share Bench with Steel Legs, Wooden shell with visible fasteners, 1000 mm	6.2		-	3.718	4.163
	<b>64341*</b> Share Bench with Steel Legs, Wooden shell, 1000 mm	6.2		-	3.718	4.163
	<b>SHH16</b> Share Bench with Steel Legs, Seat pad, wooden shell, 1000 mm	7.1		1 2 3 4 5 6 7 8 10	5.874 6.148 6.423 6.696 6.971 7.244 7.519 7.794 8.370	6.319 6.593 6.868 7.141 7.416 7.689 7.964 8.239 8.815
	<b>SHH14</b> Share Bench with Steel Legs, Fully upholstered, 1000 mm	6.8		1 2 3 4 5 6 7 8 10	6.539 6.813 7.088 7.361 7.634 7.907 8.183 8.456 9.032	

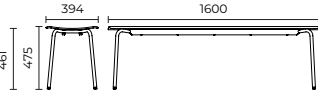
# Share Bench with Steel Legs

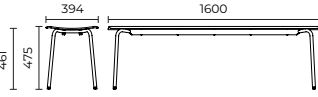
[Content ↗](#)

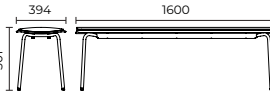
Design by Strand+Hvass

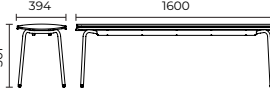
Product	Description (Item nr)	Weight (Kg)	Dimensions (mm)	Band	Veneer (SEK)	Optional veneer (SEK)
	<b>SHH215</b> Share Bench with Steel Legs, Wooden shell with visible fasteners, 1200 mm	7		-	3.984	4.429
	<b>64342*</b> Share Bench with Steel Legs, Wooden shell, 1200 mm	7		-	3.984	4.429
	<b>SHH216</b> Share Bench with Steel Legs, Seat pad, wooden shell, 1200 mm	8.1		1 2 3 4 5 6 7 8 10	6.265 6.663 7.062 7.460 7.859 8.257 8.655 9.053 9.755	6.710 7.108 7.507 7.905 8.304 8.702 9.100 9.498 10.200
	<b>SHH214</b> Share Bench with Steel Legs, Fully upholstered, 1200 mm	7.6		1 2 3 4 5 6 7 8 10	6.929 7.327 7.726 8.124 8.523 8.921 9.319 9.717 10.420	
	<b>SHH315</b> Share Bench with Steel Legs, Wooden shell with visible fasteners, 1600 mm	5.1		-	4.647	5.092
	<b>64343*</b> Share Bench with Steel Legs, Wooden shell, 1600 mm	5.1		-	4.647	5.092
	<b>SHH316</b> Share Bench with Steel Legs, Seat pad, wooden shell, 1600 mm	6.5		1 2 3 4 5 6 7 8 10	7.884 8.571 9.261 9.949 10.639 11.327 12.015 12.705 13.697	8.329 9.016 9.706 10.394 11.084 11.772 12.460 13.150 14.142
	<b>SHH314</b> Share Bench with Steel Legs, Fully upholstered, 1600 mm	5.9		1 2 3 4 5 6 7 8 10	7.221 7.907 8.597 9.286 9.975 10.663 11.352 12.041 13.034	

ACCESSORIES	Description	Weight (Kg)	Dimensions (mm)	Price (SEK)
	<b>CHAIR FEET</b> Felt glides, set of 4 pcs. height + 0,2 cm	1,82 g x 4		208







## FEATURES

- CMHR foam

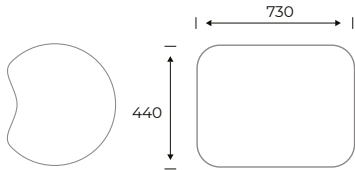
For product information visit [oceefour.com](https://oceefour.com) ↗

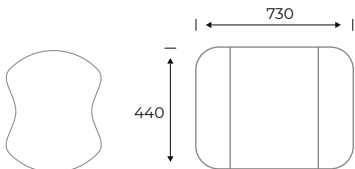
For full colour details [go to page 236](#) ↗

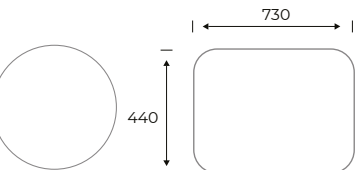
Product	Description (Item nr)	Weight (Kg)	Dimensions (mm)	Band	Standard (SEK)
	<b>CASINOCA1</b> Casino CAS1C, CAS1C	-		<ul style="list-style-type: none"> <li>1</li> <li>2</li> <li>3</li> <li>4</li> <li>5</li> <li>6</li> <li>7</li> </ul>	<ul style="list-style-type: none"> <li>3.787</li> <li>4.234</li> <li>4.646</li> <li>5.442</li> <li>6.510</li> <li>8.127</li> <li>9.794</li> </ul>
	<b>CASINOCA2</b> Casino CAS2C, CAS2C	-		<ul style="list-style-type: none"> <li>1</li> <li>2</li> <li>3</li> <li>4</li> <li>5</li> <li>6</li> <li>7</li> </ul>	<ul style="list-style-type: none"> <li>3.787</li> <li>4.234</li> <li>4.646</li> <li>5.442</li> <li>6.510</li> <li>8.127</li> <li>9.794</li> </ul>
	<b>CASINOCAC</b> Casino CAS1CIRC, CAS1CIRC	-		<ul style="list-style-type: none"> <li>1</li> <li>2</li> <li>3</li> <li>4</li> <li>5</li> <li>6</li> <li>7</li> </ul>	<ul style="list-style-type: none"> <li>3.787</li> <li>4.234</li> <li>4.646</li> <li>5.442</li> <li>6.510</li> <li>8.127</li> <li>9.794</li> </ul>





# FourReal® 74 with Angled Legs

Design by Studio Ocee

[Content ↗](#)



## FEATURES

- Table height 74 cm. Angled legs - integrated castors on two legs.
- With height adjustment glides on the other two legs to aid movement
- Foldable by one person without the use of tools. Matching ABS edges.
- Room In Room & Chair suspension options. Room In Room comes in Decor as standard.
- Electrical units are optional and will be positioned in the centre of tables as standard.



For product information visit [oceefour.com](https://oceefour.com) ↗

## TABLE TOP

Decor



Laminate



Fenix laminate



Linoleum



## FRAME COLOURS

Standard



Frame optional\*



For electrical accessories [go to page 228](#) ↗

For full colour details [go to page 236](#) ↗









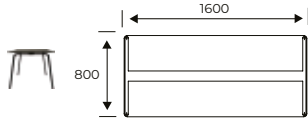

Product	Description (Item nr)	Weight (Kg)	Chair suspension	Dimensions (mm)	Top/Band	Price (SEK)
	<b>21980</b> FourReal® 74 with Angled Legs, 80 x 80, Folding legs	19.5	2		Decor Laminate Fenix laminate Linoleum	6.245 6.712 8.003 9.407
	<b>21800</b> FourReal® 74L with Angled Legs, 128 x 64, Folding legs	21.4	2		Decor Laminate Fenix laminate Linoleum	6.525 7.377 9.195 11.021
	<b>21810</b> FourReal® 74L with Angled Legs, 140 x 70, Folding legs	24.1	2		Decor Laminate Fenix laminate Linoleum	6.731 7.745 10.005 11.390
	<b>21900</b> FourReal® 74 with Angled Legs, 120 x 80, Folding legs	24	4		Decor Laminate Fenix laminate Linoleum	6.615 7.628 9.781 11.146
	<b>21910</b> FourReal® 74 with Angled Legs, 140 x 80, Folding legs	26.3	4		Decor Laminate Fenix laminate Linoleum	6.909 7.987 10.648 11.797

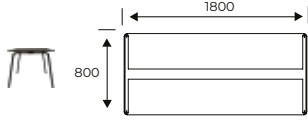
For tabletop cutout placements go to: [Oceedesign.com/Cutout.pdf](https://Oceedesign.com/Cutout.pdf)

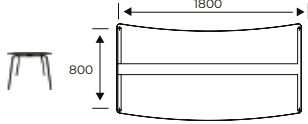
# FourReal® 74 with Angled Legs

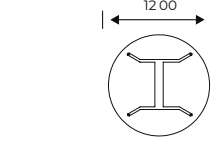
[Content ↗](#)

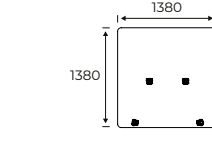
Design by Studio Ocee

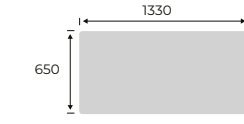



Product	Description (Item nr)	Weight (Kg)	Chair suspension	Dimensions (mm)	Top/Band	Price (SEK)
	<b>21950</b> FourReal® 74 with Angled Legs, 160 x 80, Folding legs	31.6	4		Decor	7.280
					Laminate	8.599
					Fenix laminate	11.765
					Linoleum	12.375
	<b>21920</b> FourReal® 74 with Angled Legs, 180 x 80, Folding legs	31.5	6		Decor	7.481
					Laminate	8.930
					Fenix laminate	12.368
					Linoleum	12.684
	<b>219A0</b> FourReal® 74 with Angled Legs, 180 x 80 curve, Folding legs	39.7	6		Decor	8.151
					Laminate	9.601
					Fenix laminate	13.593
					Linoleum	14.679
	<b>21930</b> FourReal® 74 with Angled Legs, Ø120, Folding legs	27	2		Decor	7.247
					Laminate	8.532
					Fenix laminate	11.858
					Linoleum	13.373
	<b>2421</b> Room in Room, FourReal® 74 with Angled Legs	26.3	-		Decor	3.502
					Laminate	
					Fenix laminate	
					Linoleum	
	<b>2430000</b> Acoustic for RinR, 133 x 65	6.7	-		1	2.852
					2	3.065
					3	3.279
					4	3.503
					5	3.706
					6	3.909

[For tabletop cutout placements go to: Oceedesign.com/Cutout.pdf](https://oceedesign.com/Cutout.pdf)

# FourReal® 74 with Angled Legs

Design by Studio Ocee

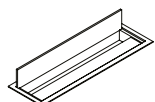
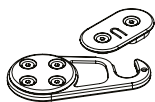
[Content ↗](#)

ACCESSORIES	Description	Weight (Kg)	Dimensions (mm)	Price (SEK)
	<b>CHAIR SUSPENSION</b> Chair suspension for FourCast2 Four, FourCast2 Line, FourSure 44, FourSure 88, FourSure 11, FourSure 99, Four Stools, Four Seating Benches	0,3 Kg		255
	<b>CHAIR SUSPENSION</b> Chair suspension for FourCast2 Wheeler, FourSure 66	0,3 Kg		255
	<b>CABLE CUT OUT</b> Cable duct, aluminum. Cable duct placed in apron			2.030
	<b>CABLE CUT OUT</b>			711
	<b>LINKING DEVICE</b> Linking Device, set of 4 pcs - 2 x he, 2 x she per table			525
	<b>TABLE TROLLEY - 20100001</b> Trolley for 10 Folded Tables or 7 round tables, including strap	20 Kg	1720 mm x 550 mm x 980 mm. Folded Table: 150 mm	8.773
SURCHARGE				Price (SEK)
<b>FRAME OPTIONAL</b>	 6			382



# FourReal® 74 with Straight Legs

Design by Studio Ocee

[Content ↗](#)



## FEATURES

- Table height 74 cm. Straight legs – Integrated castors on two legs.
- With height adjustment glides on the other two legs to aid movement
- Foldable by one person without the use of tools. Matching ABS edges.
- Room In Room & Chair suspension options. Room In Room comes in Decor as standard.
- Electrical units are optional and will be positioned in the centre of tables as standard.



For product information visit [oceefour.com](http://oceefour.com) ↗

## TABLE TOP

Decor



04 05 06

Laminate



01 02 03

Fenix laminate



07 08 09

Linoleum



10

## FRAME COLOURS

Standard



B C K

Frame optional\*



6

For electrical accessories [go to page 228](#) ↗

For full colour details [go to page 236](#) ↗

Product	Description (Item nr)	Weight (Kg)	Chair suspension	Dimensions (mm)	Top/Band	Price (SEK)
	<b>22080</b> FourReal® 74 with Straight Legs, 80 x 80, Folding legs	20.2	2		Decor Laminate Fenix laminate Linoleum	6.245 6.712 8.003 9.407
	<b>21600</b> FourReal® 74L with Straight Legs, 128 x 64, Folding legs	22	2		Decor Laminate Fenix laminate Linoleum	6.525 7.377 9.195 11.021
	<b>21610</b> FourReal® 74L with Straight Legs, 140 x 70, Folding legs	24.7	2		Decor Laminate Fenix laminate Linoleum	6.731 7.745 10.005 11.390
	<b>22000</b> FourReal® 74 with Straight Legs, 120 x 80, Folding legs	24.6	4		Decor Laminate Fenix laminate Linoleum	6.615 7.628 9.781 11.146
	<b>22010</b> FourReal® 74 with Straight Legs, 140 x 80, Folding legs	26.9	4		Decor Laminate Fenix laminate Linoleum	6.909 7.987 10.648 11.797









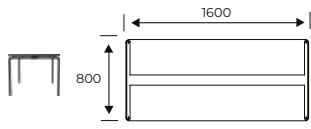

For tabletop cutout placements go to: [Oceedesign.com/Cutout.pdf](http://Oceedesign.com/Cutout.pdf)

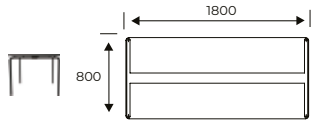

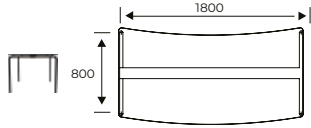
# FourReal® 74 with Straight Legs

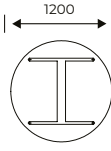
Design by Studio Ocee

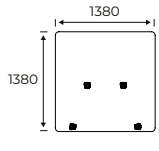
[Content ↗](#)

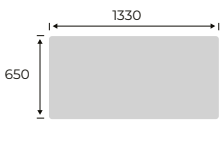

Product	Description (Item nr)	Weight (Kg)	Chair suspension	Dimensions (mm)	Top/Band	Price (SEK)
	<b>22050</b> FourReal® 74 with Straight Legs, 160 x 80, Folding legs	32.2	4		Decor	7.280
					Laminate	8.599
					Fenix laminate	11.765
					Linoleum	12.375
	<b>22020</b> FourReal® 74 with Straight Legs, 180 x 80, Folding legs	32.2	6		Decor	7.481
					Laminate	8.930
					Fenix laminate	12.368
					Linoleum	12.684
	<b>220A0</b> FourReal® 74 with Straight Legs, 180 x 80 curve, Folding legs	-	6		Decor	8.151
					Laminate	9.601
					Fenix laminate	13.593
					Linoleum	14.679
	<b>22030</b> FourReal® 74 with Straight Legs, Ø120, Folding legs	28.1	2		Decor	7.247
					Laminate	8.532
					Fenix laminate	11.858
					Linoleum	13.373
	<b>2420</b> Room in Room, FourReal® 74 with Straight Legs	26.3	-		Decor	3.502
					Laminate	
					Fenix laminate	
					Linoleum	
	<b>2430000</b> Acoustic for RinR, 133 x 65	6.7	-		1	2.852
					2	3.065
					3	3.279
					4	3.503
					5	3.706
					6	3.909

For tabletop cutout placements go to: [Oceedesign.com/Cutout.pdf](https://oceedesign.com/Cutout.pdf)

# FourReal® 74 with Straight Legs

Design by Studio Ocee

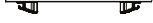
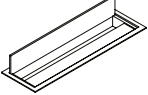
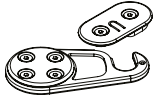
[Content ↗](#)

ACCESSORIES	Description	Weight (Kg)	Dimensions (mm)	Price (SEK)
	<b>CHAIR SUSPENSION</b> Chair suspension for FourCast2 Four, FourCast2 Line, FourSure 44, FourSure 88, FourSure 11, FourSure 99, Four Stools, Four Seating Benches	0,3 Kg		255
	<b>CHAIR SUSPENSION</b> Chair suspension for FourCast2 Wheeler, FourSure 66	0,3 Kg		255
	<b>CABLE CUT OUT</b> Cable duct, aluminum. Cable duct placed in apron			2.030
	<b>CABLE CUT OUT</b>			711
	<b>LINKING DEVICE</b> Linking Device, set of 4 pcs - 2 x he, 2 x she per table			525
	<b>TABLE TROLLEY - 20100001</b> Trolley for 10 Folded Tables or 7 round tables, including strap	20 Kg	1720 mm x 550 mm x 980 mm. Folded Table: 150 mm	8.773
SURCHARGE				Price (SEK)
<b>FRAME OPTIONAL</b>	 6			382

# FourReal® 741 Flake

Design by Studio Ocee

[Content ↗](#)



## FEATURES



- Table height 74 cm. Angled legs – integrated castors on two legs
- With height adjustment glides on the other two legs to aid movement
- Foldable by one person without the use of tools. Matching ABS edges.
- Room In Room & Chair suspension options. Room In Room comes in Decor as standard.
- Powder coated frame options
- Electrical units are optional and will be positioned in the centre of tables as standard.

For product information visit [oceefour.com](http://oceefour.com) ↗

## TABLE TOP

Decor



Laminate



Fenix laminate



Linoleum



## FRAME COLOURS

Standard



Frame optional\*





For electrical accessories [go to page 228](#) ↗

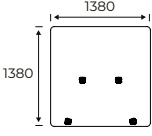

For full colour details [go to page 236](#) ↗

Product	Description (Item nr)	Weight (Kg)	Chair suspension	Dimensions (mm)	Top/Band	Price (SEK)
	<b>21700</b> FourReal® 741 Flake, 140 x 100, Folding legs	33.9	4		Decor Laminate Fenix laminate Linoleum	8.126 9.446 13.079 14.279
	<b>21720</b> FourReal® 741 Flake, 200 x 100, Folding legs	50.3	0		Decor Laminate Fenix laminate Linoleum	11.082 12.999 18.146 19.612
	<b>21750</b> FourReal® 741 Flake, 198 x 100 ellipse, Folding legs	37.1	4		Decor Laminate Fenix laminate Linoleum	10.814 12.682 17.703 19.119
	<b>21760</b> FourReal® 741 Flake, 160 x 100 half ellipse, Folding legs	31.6	4		Decor Laminate Fenix laminate Linoleum	8.514 9.783 12.323 13.308
	<b>21770</b> FourReal® 741 Flake, 140 x 129 Diamond, Folding legs	30.4	3		Decor Laminate Fenix laminate Linoleum	9.029 10.872 13.955 15.068

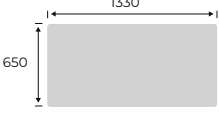
For tabletop cutout placements go to: [Oceedesign.com/Cutout.pdf](http://Oceedesign.com/Cutout.pdf)

Product	Description (Item nr)	Weight (Kg)	Chair suspension	Dimensions (mm)	Top/Band	Price (SEK)
	<b>2422</b> Room in Room, FourReal 741	26.4	-		Decor Laminate Fenix laminate Linoleum	3.502
	<b>2430000</b> Acoustic for RinR, 133 x 65	6.7	-		1 2 3 4 5 6	2.852 3.065 3.279 3.503 3.706 3.909

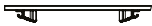
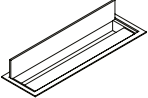
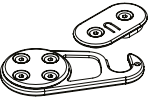
For tabletop cutout placements go to: [Oceedesign.com/Cutout.pdf](https://oceedesign.com/Cutout.pdf)

ACCESSORIES	Description	Weight (Kg)	Dimensions (mm)	Price (SEK)
	<b>CHAIR SUSPENSION</b> Chair suspension for FourCast2 Four, FourCast2 Line, FourSure 44, FourSure 88, FourSure 11, FourSure 99, Four Stools, Four Seating Benches	0,3 Kg		255
	<b>CHAIR SUSPENSION</b> Chair suspension for FourCast2 Wheeler, FourSure 66	0,3 Kg		255
	<b>CABLE CUT OUT</b> Cable duct, aluminum. Cable duct placed in apron			2.030
	<b>CABLE CUT OUT</b>			711
	<b>LINKING DEVICE</b> Linking Device, set of 4 pcs - 2 x he, 2 x she per table			525
	<b>TABLE TROLLEY - 20100001</b> Trolley for 10 Folded Tables or 7 round tables, including strap	20 Kg	1720 mm x 550 mm x 980 mm. Folded Table: 150 mm	8.773

SURCHARGE		Price (SEK)
<b>FRAME OPTIONAL</b>	 6	382



## FEATURES



- Table height 74 cm. Angled legs - integrated castors on two legs
- Optional 25 mm gap between tabletops for accessory mounting
- Personalise with trays, paper rolls, power cubes, acoustic panels and cable nets
- Electrical installation option for tabletops without 25 mm gap
- Possibility of chair suspension and to install cable net
- Powder-coated frame colour
- ABS edge matches tabletop colour
- Delivered flat-packed; easy to assemble and install

For product information visit [oceefour.com](https://oceefour.com) ↗

## TABLE TOP

Decor



Laminate



## FRAME COLOURS

Standard



Fenix laminate



Linoleum







For electrical accessories [go to page 228](#) ↗



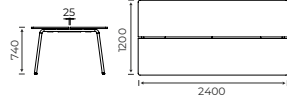

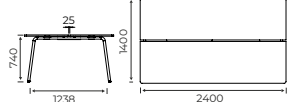

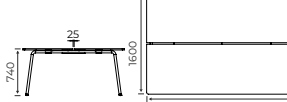
For full colour details [go to page 236](#) ↗

Product	Description (Item nr)	Weight (Kg)	Max Chair suspension	Dimensions (mm)	Top/Band	Price (SEK)
	<b>REE16</b> FourReal® Flex, 120x120	37,8	4		Decor	11.717
					Laminate	13.730
					Fenix laminate	16.492
					Linoleum	18.406
	<b>REE2H</b> FourReal® Flex, 140x140	47,3	4		Decor	13.280
					Laminate	17.000
					Fenix laminate	18.163
					Linoleum	22.414
	<b>REE35</b> FourReal® Flex, 160x160	57,7	4		Decor	14.842
					Laminate	19.710
					Fenix laminate	26.514
					Linoleum	25.875
	<b>REE3U</b> FourReal® Flex, 180x120	43,6	6		Decor	17.030
					Laminate	20.001
					Fenix laminate	22.572
					Linoleum	26.353
	<b>REE4C</b> FourReal® Flex, 200x140	54,2	6		Decor	19.530
					Laminate	25.716
					Fenix laminate	27.388
					Linoleum	32.524

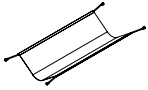
For tabletop cutout placements go to: [Oceefour.com/Cutout.pdf](https://oceefour.com/Cutout.pdf)

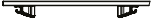
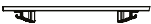
Product	Description (Item nr)	Weight (Kg)	Max Chair suspension	Dimensions (mm)	Top/Band	Price (SEK)
	<b>REE69</b> FourReal® Flex, 240x120	65,7	8		Decor	20.155
					Laminate	20.155
					Fenix laminate	30.415
					Linoleum	33.835
	<b>REE6A</b> FourReal® Flex, 240x140	73,4	8		Decor	22.811
					Laminate	29.579
					Fenix laminate	32.478
					Linoleum	38.143
	<b>REE6B</b> FourReal® Flex, 240x160	81,2	8		Decor	26.405
					Laminate	34.999
					Fenix laminate	45.159
					Linoleum	43.680

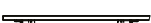
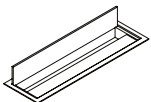
For tabletop cutout placements go to: [Oceefour.com/Cutout.pdf](https://Oceefour.com/Cutout.pdf)

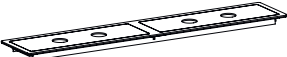
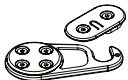
ACCESSORIES	Description	Weight (Kg)	Dimensions (mm)	Price (SEK)
	<b>CABLE NET 620 – ACC1005</b>		620 x H106 mm	452
	<b>PAPER ROLL HOLDER – ACC1003</b> Incl. paper	2,6	L535 x W104 xH152 mm	764
	<b>2 X CHAIR SUSPENSION</b>			510
	<b>4 X CHAIR SUSPENSION</b>			1020
	<b>6 X CHAIR SUSPENSION</b>			1530
	<b>8 X CHAIR SUSPENSION</b>			2040
	<b>CABLE CUT OUT</b> Cable duct, aluminum. Cable duct placed in apron			2.030
	<b>CD SINGLE</b> CD1 Cable duct, Single, incl., hole in table top. Aluminium			3415
	<b>CD DOUBLE</b> CD2: Cable duct, double, incl., hole in table top. Aluminium			4183
	<b>LINKING DEVICE</b> Linking Device, set of 4 pcs - 2 x he, 2 x she per table			525



## FEATURES

- Table height 90 cm. Angled legs – Integrated castors on two legs.
- With height adjustment glides on the other two legs to aid movement.
- Foldable by one person without use of tools. Matching ABS edges.
- Room In Room & Chair suspension options. Room In Room comes in Decor as standard.
- Electrical units are optional and will be positioned in the centre of tables as standard.



For product information visit [oceefour.com](https://oceefour.com) ↗

## TABLE TOP

Decor



Laminate



Fenix laminate



Linoleum



## FRAME COLOURS

Standard



Frame optional\*







For electrical accessories [go to page 228](#) ↗

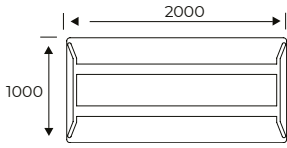

For full colour details [go to page 236](#) ↗

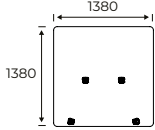
Product	Description (Item nr)	Weight (Kg)	Chair suspension	Dimensions (mm)	Top/Band	Price (SEK)
	<b>22300</b> FourReal® 90, 140 x 60, Folding legs	25.1	0		Decor Laminate Fenix laminate Linoleum	7.326 8.440 10.510 11.423
	<b>22310</b> FourReal® 90, 140 x 80, Folding legs	30.2	4		Decor Laminate Fenix laminate Linoleum	7.559 8.706 11.313 12.380
	<b>22380</b> FourReal® 90, 160 x 80, Folding legs	30.5	4		Decor Laminate Fenix laminate Linoleum	7.941 9.147 12.744 13.578
	<b>22320</b> FourReal® 90, 180 x 60, Folding legs	27.5	0		Decor Laminate Fenix laminate Linoleum	7.946 9.154 11.984 12.590
	<b>22330</b> FourReal® 90, 180 x 80, Folding legs	33.1	6		Decor Laminate Fenix laminate Linoleum	8.150 9.384 13.515 14.221

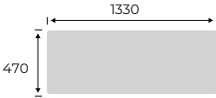
For tabletop cutout placements go to: [Oceedesign.com/Cutout.pdf](https://Oceedesign.com/Cutout.pdf)

Product	Description (Item nr)	Weight (Kg)	Chair suspension	Dimensions (mm)	Top/Band	Price (SEK)
	<b>22360</b> FourReal® 90, 200 x 100, Folding legs	51.4	0		Decor	11.280
					Laminate	13.214
					Fenix laminate	18.347
					Linoleum	19.810
	<b>2423</b> Room in Room, FourReal 90	26.4	-		Decor	3.502
					Laminate	
					Fenix laminate	
					Linoleum	
	<b>2430001</b> Acoustic for RinR, 133 x 47	4.8	-		1	2.852
					2	3.065
					3	3.279
					4	3.503
					5	3.706
					6	3.909

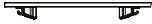
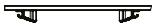
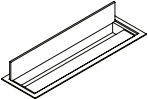
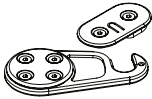
For tabletop cutout placements go to: [Oceedesign.com/Cutout.pdf](https://oceedesign.com/Cutout.pdf)

ACCESSORIES	Description	Weight (Kg)	Dimensions (mm)	Price (SEK)
	<b>CHAIR SUSPENSION</b> Chair suspension for FourCast2 Four, FourCast2 Line, FourSure 44, FourSure 88, FourSure 11, FourSure 99, Four Stools, Four Seating Benches	0,3 Kg		255
	<b>CHAIR SUSPENSION</b> Chair suspension for FourCast2 Wheeler, FourSure 66	0,3 Kg		255
	<b>CABLE CUT OUT</b> Cable duct, aluminum. Cable duct placed in apron			2.030
	<b>CABLE CUT OUT</b>			711
	<b>LINKING DEVICE</b> Linking Device, set of 4 pcs - 2 x he, 2 x she per table			525
	<b>TABLE TROLLEY - 20100001</b> Trolley for 10 Folded Tables or 7 round tables, including strap	20 Kg	1720 mm x 550 mm x 980 mm. Folded Table: 150 mm	8.773
SURCHARGE				Price (SEK)
<b>FRAME OPTIONAL</b>	 6			382





## FEATURES



- Table height 105 cm. Angled legs – Integrated castors on two legs.
- Foldable by one person without the use of tools. Matching ABS edges.
- Room In Room & Chair suspension options. Room In Room comes in Decor as standard.
- Electrical units are optional and will be positioned in the centre of tables as standard.

For product information visit [oceefour.com](http://oceefour.com) ↗

### TABLE TOP

Decor



Laminate



Fenix laminate



Linoleum



### FRAME COLOURS

Standard



Frame optional\*





For electrical accessories [go to page 228](#) ↗

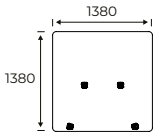

For full colour details [go to page 236](#) ↗

Product	Description (Item nr)	Weight (Kg)	Chair suspension	Dimensions (mm)	Top/Band	Price (SEK)
	<b>22400</b> FourReal® 105, 140 x 60, Folding legs	26.1	0		Decor Laminate Fenix laminate Linoleum	7.323 8.440 10.510 11.423
	<b>22410</b> FourReal® 105, 140 x 80, Folding legs	31.2	4		Decor Laminate Fenix laminate Linoleum	7.559 8.706 11.313 12.380
	<b>22480</b> FourReal® 105, 160 x 80, Folding legs	31.5	4		Decor Laminate Fenix laminate Linoleum	7.941 9.147 12.744 13.578
	<b>22420</b> FourReal® 105, 180 x 60, Folding legs	28.4	0		Decor Laminate Fenix laminate Linoleum	7.946 9.154 11.984 12.590
	<b>22430</b> FourReal® 105, 180 x 80, Folding legs	34.2	6		Decor Laminate Fenix laminate Linoleum	8.150 9.384 13.515 14.266

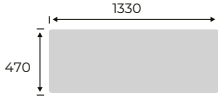
For tabletop cutout placements go to: [Oceedesign.com/Cutout.pdf](http://Oceedesign.com/Cutout.pdf)

Product	Description (Item nr)	Weight (Kg)	Chair suspension	Dimensions (mm)	Top/Band	Price (SEK)
	<b>2424</b> Room in Room, FourReal 105	26.4	-		Decor Laminate Fenix laminate Linoleum	3.502
	<b>2430001</b> Acoustic for RinR, 133 x 47	4.8	-		1 2 3 4 5 6	2.852 3.065 3.279 3.503 3.706 3.909

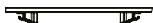
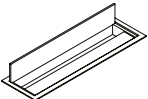
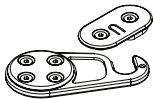
For tabletop cutout placements go to: [Oceedesign.com/Cutout.pdf](https://oceedesign.com/Cutout.pdf)

ACCESSORIES	Description	Weight (Kg)	Dimensions (mm)	Price (SEK)
	<b>CHAIR SUSPENSION</b> Chair suspension for FourCast2 Four, FourCast2 Line, FourSure 44, FourSure 88, FourSure 11, FourSure 99, Four Stools, Four Seating Benches	0,3 Kg		255
	<b>CHAIR SUSPENSION</b> Chair suspension for FourCast2 Wheeler, FourSure 66	0,3 Kg		255
	<b>CABLE CUT OUT</b> Cable duct, aluminum. Cable duct placed in apron			2.030
	<b>CABLE CUT OUT</b>			711
	<b>LINKING DEVICE</b> Linking Device, set of 4 pcs - 2 x he, 2 x she per table			525
	<b>TABLE TROLLEY - 20100001</b> Trolley for 10 Folded Tables or 7 round tables, including strap	20 Kg	1720 mm x 550 mm x 980 mm. Folded Table: 150 mm	8.773

SURCHARGE		Price (SEK)
<b>FRAME OPTIONAL</b>	 6	382



## FEATURES

- Table height 74 cm – integrated castors on two legs.
- Matching ABS edges.
- Chair suspension, Flower box & Top-shelf options.
- Powder coated frame options.
- Delivered unassembled.
- Electrical units are optional and will be positioned in the centre of tables as standard.

For product information visit [oceefour.com](http://oceefour.com) ↗

## TABLE TOP

Decor



Laminate



Fenix laminate



Linoleum



## FRAME COLOURS

Standard







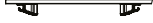

For electrical accessories [go to page 228](#) ↗

For full colour details [go to page 236](#) ↗

Product	Description (Item nr)	Weight (Kg)	Chair suspension	Dimensions (mm)	Top	Price (SEK)
	<b>65025</b> FourReal® A 74, 140 x 80, A	44,1	4		Decor Laminate Fenix laminate Linoleum	9.130 9.961 13.215 14.753
	<b>65015</b> FourReal® A 74, 180 x 80, A	52	6		Decor Laminate Fenix laminate Linoleum	9.713 10.921 14.963 15.652

For tabletop cutout placements go to: [Oceedesign.com/Cutout.pdf](http://Oceedesign.com/Cutout.pdf)

ACCESSORIES	Description	Weight (Kg)	Dimensions (mm)	Price (SEK)
	<b>CHAIR SUSPENSION</b> Chair suspension for FourCast2 Four, FourCast2 Line, FourSure 44, FourSure 88, FourSure 11, FourSure 99, Four Stools, Four Seating Benches	0,3 Kg		255
	<b>CHAIR SUSPENSION</b> Chair suspension for FourCast2 Wheeler, FourSure 66	0,3 Kg		255
	<b>699000008</b> Table Accessories, Flower box black, 60 cm	0,4 Kg	L600 x W160 x H140 mm	438
	<b>699000005</b> Table Accessories, Flower box black, 80 cm	0,5 Kg	L800 x W160 x H140 mm	438
	<b>699000001</b> Table Accessories, Top shelf white, 60 cm x 20,5 cm	1,5 Kg	600 x 205 mm	438
	<b>699000002</b> Table Accessories, Top shelf black, 60 cm x 20,5 cm	1,5 Kg	600 x 205 mm	438
	<b>699000003</b> Table Accessories, Top shelf grey, 60 cm x 20,5 cm	1,5 Kg	600 x 205 mm	438



## FEATURES

- Table height 74 cm – integrated castors on two legs
- Matching ABS edges.
- Chair suspension, Flower box & Top-shelf options.
- Powder coated frame options.
- Delivered unassembled.
- Electrical units are optional and will be positioned in the centre of tables as standard.

For product information visit [oceefour.com](https://oceefour.com) ↗

## TABLE TOP

Decor



Laminate



Fenix laminate



Linoleum



## FRAME COLOURS

Standard



For electrical accessories [go to page 228](#) ↗

For full colour details [go to page 236](#) ↗

Product	Description (Item nr)	Weight (Kg)	Chair suspension	Dimensions (mm)	Top	Price (SEK)
	<b>65205</b> FourReal® A XL 74, 180 x 100, A	69.4	6		Decor Laminate Fenix laminate Linoleum	16.268 17.647 20.144 22.468
	<b>65215</b> FourReal® A XL 74, 200 x 100, A	74.4	6		Decor Laminate Fenix laminate Linoleum	18.076 19.608 22.381 24.964
	<b>65225</b> FourReal® A XL 74, 240 x 100, A	84.4	8		Decor Laminate Fenix laminate Linoleum	20.660 22.364 25.808 28.391
	<b>65209</b> FourReal® A XL 74, 180 x 100, A extension	58.7	6		Decor Laminate Fenix laminate Linoleum	13.685 15.063 17.561 19.884
	<b>65219</b> FourReal® A XL 74, 200 x 100, A extension	63.6	6		Decor Laminate Fenix laminate Linoleum	15.493 17.214 19.797 22.381

For tabletop cutout placements go to: [Oceedesign.com/Cutout.pdf](https://Oceedesign.com/Cutout.pdf)





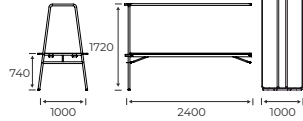

# FourReal® A XL 74

Design by Studio Ocee

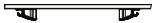
[Content ↗](#)

Product	Description (Item nr)	Weight (Kg)	Chair suspension	Dimensions (mm)	Top	Price (SEK)
	<b>65229</b> FourReal® A XL 74, 240 x 100, A extension	77.5	8		Decor	18.076
					Laminate	19.781
					Fenix laminate	23.224
					Linoleum	25.808

For tabletop cutout placements go to: [Oceedesign.com/Cutout.pdf](https://oceedesign.com/Cutout.pdf)

ACCESSORIES	Description	Weight (Kg)	Dimensions (mm)	Price (SEK)
	<b>CHAIR SUSPENSION</b> Chair suspension for FourCast2 Four, FourCast2 Line, FourSure 44, FourSure 88, FourSure 11, FourSure 99, Four Stools, Four Seating Benches	0,3 Kg		255
	<b>CHAIR SUSPENSION</b> Chair suspension for FourCast2 Wheeler, FourSure 66	0,3 Kg		255
	<b>699000008</b> Table Accessories, Flower box black, 60 cm	0,4 Kg	L600 x W160 x H140 mm	438
	<b>699000005</b> Table Accessories, Flower box black, 80 cm	0,5 Kg	L800 x W160 x H140 mm	438
	<b>699000001</b> Table Accessories, Top shelf white, 60 cm x 20,5 cm	1,5 Kg	600 x 205 mm	438
	<b>699000002</b> Table Accessories, Top shelf black, 60 cm x 20,5 cm	1,5 Kg	600 x 205 mm	438
	<b>699000003</b> Table Accessories, Top shelf grey, 60 cm x 20,5 cm	1,5 Kg	600 x 205 mm	438



## FEATURES



- Table height 74 cm – integrated castors on two legs
- Optional 25 mm gap between tabletops for accessory mounting
- Personalise with trays, paper rolls, power cubes, acoustic panels and cable nets
- Available with a flower box and top shelf
- Electrical installation option for tabletops without 25 mm gap
- Possibility of chair suspension and to install cable net
- Powder-coated frame colour
- ABS edge matches tabletop colour
- Delivered flat-packed; easy to assemble and install

For product information visit [oceefour.com](https://oceefour.com) ↗

## TABLE TOP

Decor



05

06

07

Laminate



02

03

04

## FRAME COLOURS

Standard



01

02

03

Fenix laminate



08

09

10

Linoleum













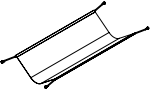
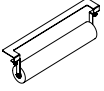

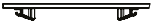
11

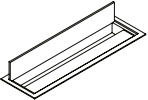
For electrical accessories [go to page 228](#) ↗

For full colour details [go to page 236](#) ↗

Product	Description (Item no)	Weight (Kg)	Max Chair suspension	Dimensions (mm)	Top/Band	Price (SEK)
	<b>REF2E1</b> FourReal® A Flex, 140x120, 74	68	4		Decor Laminate Fenix laminate Linoleum	17.492 19.573 22.604 25.916
	<b>REF2H1</b> FourReal® A Flex, 140x140, 74	72	4		Decor Laminate Fenix laminate Linoleum	18.117 21.837 23.000 27.251
	<b>REF691</b> FourReal® A Flex, 240x120, 74	96,3	8		Decor Laminate Fenix laminate Linoleum	26.405 32.677 36.665 40.085
	<b>REF6A1</b> FourReal® A Flex, 240x140, 74	103,2	8		Decor Laminate Fenix laminate Linoleum	28.905 35.673 38.572 44.237

For tabletop cutout placements go to: [Oceefour.com/Cutout.pdf](https://oceefour.com/Cutout.pdf)

ACCESSORIES	Description	Weight (Kg)	Dimensions (mm)	Price (SEK)
	<b>CABLE NET 620 – ACC1005</b>		L620 x H106 mm	452
	<b>PAPER ROLL HOLDER – ACC1003</b> Incl. paper	2,6 Kg	L535 x W104 x H152 mm	764
	<b>2 X CHAIR SUSPENSION</b>			510
	<b>4 X CHAIR SUSPENSION</b>			1020
	<b>6 X CHAIR SUSPENSION</b>			1530
	<b>8 X CHAIR SUSPENSION</b>			2040
	<b>CABLE CUT OUT</b> Cable duct, aluminum. Cable duct placed in apron			2.030
	<b>CD SINGLE</b> CD1 Cable duct, Single, incl., hole in table top. Aluminium			3415
	<b>CD DOUBLE</b> CD2: Cable duct, double, incl., hole in table top. Aluminium			4183
	<b>699000008</b> Table Accessories, Flower box black, 60 cm	0,4 Kg	L600 x W160 x H140 mm	438
	<b>699000005</b> Table Accessories, Flower box black, 80 cm	0,5 Kg	L800 x W160 x H140 mm	438
	<b>699000001</b> Table Accessories, Top shelf white, 60 cm x 20,5 cm	1,5 Kg	600 x 205 mm	438
	<b>699000002</b> Table Accessories, Top shelf black, 60 cm x 20,5 cm	1,5 Kg	600 x 205 mm	438
	<b>699000003</b> Table Accessories, Top shelf grey, 60 cm x 20,5 cm	1,5 Kg	600 x 205 mm	438



# FourReal® A 90

Design by Studio Ocee

[Content ↗](#)



## FEATURES

- Table height 90 cm – integrated castors on two legs.
- Matching ABS edges.
- Chair suspension, Flower box & Top-shelf options.
- Powder coated frame options.
- Delivered unassembled.
- Electrical units are optional and will be positioned in the centre of tables as standard.



For product information visit [oceefour.com](https://oceefour.com) ↗

## TABLE TOP

Decor



Laminate



Fenix laminate



Linoleum



## FRAME COLOURS

Standard







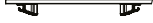

For electrical accessories [go to page 228](#) ↗

For full colour details [go to page 236](#) ↗

Product	Description (Item nr)	Weight (Kg)	Chair suspension	Dimensions (mm)	Top	Price (SEK)
	<b>65125</b> FourReal® A 90, 140 x 80, A	43.8	4		Decor Laminate Fenix laminate Linoleum	9.130 9.961 13.215 14.753
	<b>65115</b> FourReal® A 90, 180 x 80, A	51.7	6		Decor Laminate Fenix laminate Linoleum	9.713 10.921 14.963 15.652

For tabletop cutout placements go to: [Oceedesign.com/Cutout.pdf](https://Oceedesign.com/Cutout.pdf)

ACCESSORIES	Description	Weight (Kg)	Dimensions (mm)	Price (SEK)
	<b>CHAIR SUSPENSION</b> Chair suspension for FourCast2 Four, FourCast2 Line, FourSure 44, FourSure 88, FourSure 11, FourSure 99, Four Stools, Four Seating Benches	0,3 Kg		255
	<b>CHAIR SUSPENSION</b> Chair suspension for FourCast2 Wheeler, FourSure 66	0,3 Kg		255
	<b>699000008</b> Table Accessories, Flower box black, 60 cm	0,4 Kg	L600 x W160 x H140 mm	438
	<b>699000005</b> Table Accessories, Flower box black, 80 cm	0,5 Kg	L800 x W160 x H140 mm	438
	<b>699000001</b> Table Accessories, Top shelf white, 60 cm x 20,5 cm	1,5 Kg	600 x 205 mm	438
	<b>699000002</b> Table Accessories, Top shelf black, 60 cm x 20,5 cm	1,5 Kg	600 x 205 mm	438
	<b>699000003</b> Table Accessories, Top shelf grey, 60 cm x 20,5 cm	1,5 Kg	600 x 205 mm	438

# FourReal® A XL 90

Design by Studio Ocee

[Content ↗](#)



## FEATURES

- Table height 90 cm – integrated castors on two legs.
- Matching ABS edges.
- Chair suspension, Flower box & Top-shelf options.
- Powder coated frame options.
- Delivered unassembled.
- Electrical units are optional and will be positioned in the centre of tables as standard.



For product information visit [oceefour.com](https://oceefour.com) ↗

## TABLE TOP

Decor



Laminate



Fenix laminate



Linoleum



## FRAME COLOURS

Standard



For electrical accessories [go to page 228](#) ↗

For full colour details [go to page 236](#) ↗

Product	Description (Item nr)	Weight (Kg)	Chair suspension	Dimensions (mm)	Top	Price (SEK)
	<b>65305</b> FourReal® A XL 90, 180 x 100, A	69.1	6		Decor Laminate Fenix laminate Linoleum	16.268 17.647 20.144 22.468
	<b>65315</b> FourReal® A XL 90, 200 x 100, A	74.1	6		Decor Laminate Fenix laminate Linoleum	18.076 19.608 22.381 24.964
	<b>65325</b> FourReal® A XL 90, 240 x 100, A	84	8		Decor Laminate Fenix laminate Linoleum	20.660 22.364 25.808 28.391
	<b>65309</b> FourReal® A XL 90, 180 x 100, A extension	58.5	6		Decor Laminate Fenix laminate Linoleum	13.685 15.063 17.561 19.884
	<b>65319</b> FourReal® A XL 90, 200 x 100, A extension	63.5	6		Decor Laminate Fenix laminate Linoleum	15.493 17.214 19.797 22.381

For tabletop cutout placements go to: [Oceedesign.com/Cutout.pdf](https://Oceedesign.com/Cutout.pdf)





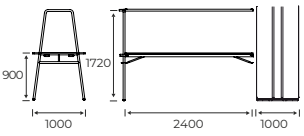

# FourReal® A XL 90

Design by Studio Ocee

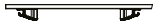
[Content ↗](#)

Product	Description (Item nr)	Weight (Kg)	Chair suspension	Dimensions (mm)	Top	Price (SEK)
	<b>65329</b> FourReal® A XL 90, 240 x 100, A extension	73.5	8		Decor	18.076
					Laminate	19.781
					Fenix laminate	23.224
					Linoleum	25.808

For tabletop cutout placements go to: [Oceedesign.com/Cutout.pdf](https://oceedesign.com/Cutout.pdf)

ACCESSORIES	Description	Weight (Kg)	Dimensions (mm)	Price (SEK)
	<b>CHAIR SUSPENSION</b> Chair suspension for FourCast2 Four, FourCast2 Line, FourSure 44, FourSure 88, FourSure 11, FourSure 99, Four Stools, Four Seating Benches	0,3 Kg		255
	<b>CHAIR SUSPENSION</b> Chair suspension for FourCast2 Wheeler, FourSure 66	0,3 Kg		255
	<b>699000008</b> Table Accessories, Flower box black, 60 cm	0,4 Kg	L600 x W160 x H140 mm	438
	<b>699000005</b> Table Accessories, Flower box black, 80 cm	0,5 Kg	L800 x W160 x H140 mm	438
	<b>699000001</b> Table Accessories, Top shelf white, 60 cm x 20,5 cm	1,5 Kg	600 x 205 mm	438
	<b>699000002</b> Table Accessories, Top shelf black, 60 cm x 20,5 cm	1,5 Kg	600 x 205 mm	438
	<b>699000003</b> Table Accessories, Top shelf grey, 60 cm x 20,5 cm	1,5 Kg	600 x 205 mm	438



## FEATURES

- Table height 74 cm. Comes with 4 Castors with brakes.
- Foldable by one person without the use of tools
- Matching ABS edges
- Powder coated frame options
- To ensure optimum stability on uneven surfaces we would recommend specifying with adjustable castors
- Delivered unassembled

For product information visit [oceefour.com](http://oceefour.com) ↗

## TABLE TOP

Decor



Laminate



Fenix laminate



## FRAME COLOURS

Standard







Frame optional\*

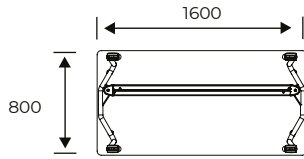

For full colour details [go to page 250](#) ↗

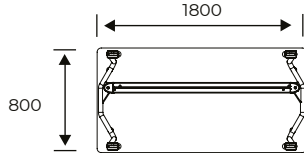
Product	Description (Item nr)	Weight (Kg)	Dimensions (mm)	Top	Price (SEK)
	<b>66040</b> FourFold®, 140 x 70, Folding leg	25.7		Decor Laminate Fenix laminate	8.056 9.291 12.339
	<b>66050</b> FourFold®, 140 x 70 trapez, Folding leg	19.9		Decor Laminate Fenix laminate	8.056 9.291 12.339
	<b>66080</b> FourFold®, 140 x 70-100 Taper, Folding leg	29.3		Decor Laminate Fenix laminate	8.589 9.877 13.003
	<b>66000</b> FourFold®, 150 x 75, Folding leg	28.5		Decor Laminate Fenix laminate	8.056 9.291 12.339
	<b>66010</b> FourFold®, 150 x 75 trapez, Folding leg	21.9		Decor Laminate Fenix laminate	8.056 9.291 12.339

Product	Description (Item nr)	Weight (Kg)	Dimensions (mm)	Top	Price (SEK)
	<b>66020</b> FourFold®, 160 x 80, Folding leg	31.3		Decor	9.065
				Laminate	10.787
				Fenix laminate	14.880
	<b>66030</b> FourFold®, 180 x 80, Folding leg	34		Decor	9.670
				Laminate	11.393
				Fenix laminate	15.486

ACCESSORIES	Description	Weight (Kg)	Dimensions (mm)	Price (SEK)
	<b>FEET</b> Height adjustable castors in black with brakes			2.053
	<b>LOCK</b> Set of 2			408

SURCHARGE		Price (SEK)
<b>FRAME OPTIONAL</b>	 6	382

# Acoustic Panels

Design by Studio Ocee

[Content](#) ↗



## FEATURES



- Made of 60% recycled PET
- Available in two colors: Anthracite or Light Grey
- Hanging version (only for FourReal® A Flex) has black elastic straps and black steel clips
- Standing version can be mounted in the 25 mm gap on FourReal® Flex/A Flex
- Standing version can also be freestanding and used across all tables
- Trapezium shape complements the FourReal® Family
- Standing panel foot doubles as a device/magazine holder

For product information visit [oceefour.com](https://oceefour.com) ↗

## FELT FINISHES

Standard



For full colour details [go to page 236](#) ↗

Product	Description (Item no)	Weight (Kg)	Dimensions (mm)	Price (SEK)
	<b>ATAC1661</b> Acoustic, Standing, 55x44T, Felt	1,6		1.905
	<b>ATAC3661</b> Acoustic, Hanging, 55x44T, Felt	0,98		1.748
	<b>ATAC1671</b> Acoustic, Standing, 110x44T, Felt	3,3		2.717
	<b>ATAC3671</b> Acoustic, Hanging, 110x44T, Felt	1,9		2.561
	<b>ATAC1681</b> Acoustic, Standing, 130x44T, Felt	3,6		2.920

# Acoustic

Design by Studio Ocee

[Content ↗](#)

Product	Description (Item no)	Weight (Kg)	Dimensions (mm)	Price (SEK)
	<b>ATAC3681</b> Acoustic, Hanging, 130x44T, Felt	2,2		2.764

ACCESSORIES	Description	Weight (Kg)	Dimensions (mm)	Price (€)
	<b>ACOUSTIC STRAP – ACC1004</b>		W50 xH440 mm	23



# Tray

Design by Studio Ocee

[Content ↗](#)



## FEATURES



- Two shapes: rectangular or circular
- Two heights: 8 cm or 14 cm
- Two finishes: natural oak or black oak veneer (70% FSC mix)
- Can be freestanding with a round steel foot
- Can be mounted in the 25 mm gap on FourReal Flex/A Flex
- Standing trays can be used across all products in our FourReal® Family
- Delivered flat-packed; easy to assemble and install

For product information visit [oceefour.com](https://oceefour.com) ↗

## COLOUR

Veneer









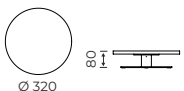

## FRAME COLOURS

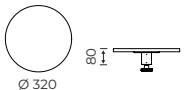
Standard





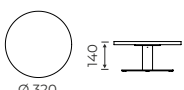

For full colour details [go to page 236](#) ↗

Product	Description (Item no)	Weight (Kg)	Dimensions (mm)	Top	Price (SEK)
	<b>ATTR1641</b> Tray, Standing, Ø32, Height 80	2,7		Veneer	1.577
	<b>ATTR2641</b> Tray, Fixed, Ø32, Height 80	1,3		Veneer	1.264
	<b>ATTR1651</b> Tray, Standing, 60x24.5, Height 80	3,3		Veneer	1.827
	<b>ATTR2651</b> Tray, Fixed, 60x24.5, Height 80	1,9		Veneer	1.514
	<b>ATTR1642</b> Tray, Standing, Ø32, Height 140	2,9		Veneer	1.592

# Tray

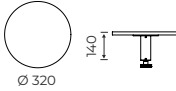
Design by Studio Ocee

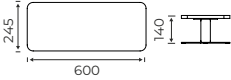
[Content ↗](#)

Product	Description (Item no)	Weight (Kg)	Dimensions (mm)	Top	Price (SEK)
	<b>ATTR2642</b> Tray, Fixed, Ø32, Height 140	1,4		Veneer	1.280
	<b>ATTR1652</b> Tray, Standing, 60x24.5, Height 140	3,4		Veneer	1.842
	<b>ATTR2652</b> Tray, Fixed, 60x24.5, Height 140	2		Veneer	1.530

# Power Cube

Design by Studio Ocee

[Content](#) ↗



## FEATURES

- Wooden power cube with Evoline ONE unit
- Power socket available in white or black
- USB A+C unit available in white or black
- GST18 socket
- 3 m black cord
- Cube available in natural or black solid oak
- 70% FSC mix

For product information visit [oceefour.com](https://oceefour.com) ↗

## COLOUR

Standard





## UNIT COLOURS

Standard

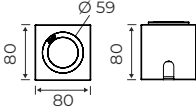

For full colour details [go to page 236](#) ↗

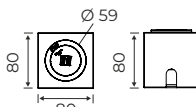
Product	Description (Item no)	Weight (Kg)	Dimensions (mm)	Colour	Price (SEK)
	<b>APOW01</b> Power Cube, Power A16	1,05		Solid oak	1.639
	<b>APOW02</b> Power Cube, USB A+C	1,05		Solid oak	2.342









## FEATURES

- Table height 72,5 cm – integrated castors on two legs.
- With height adjustment glides on the other two legs to aid movement.
- Foldable by one person without the use of tools (thickness of folded table 15 cm).
- Matching ABS edges. Powder coated frame options.
- Electrical units are optional.



For product information visit [oceefour.com](https://oceefour.com) ↗

## TABLE TOP

Decor



Laminate



Fenix laminate



Linoleum



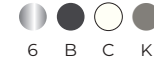

## FRAME COLOURS

Standard



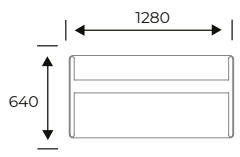

For electrical accessories [go to page 228](#) ↗

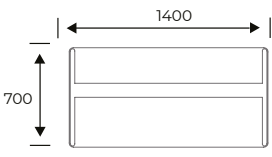
For full colour details [go to page 236](#) ↗

Product	Description (Item nr)	Weight (Kg)	Chair suspension	Dimensions (mm)	Top	Price (SEK)
	<b>11630</b> Four® Learning, 128 x 64, Folding legs	22.5	2		Decor Laminate Fenix laminate Linoleum	7.012 7.866 9.679 11.511
	<b>11610</b> Four® Learning, 140 x 70, Folding legs	25.9	2		Decor Laminate Fenix laminate Linoleum	7.215 8.233 10.493 11.879

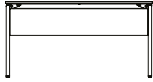
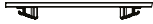
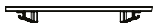
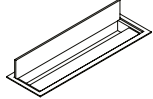
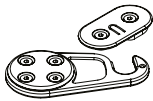
For tabletop cutout placements go to: [Oceedesign.com/Cutout.pdf](https://oceedesign.com/Cutout.pdf)

ACCESSORIES	Description	Weight (Kg)	Dimensions (mm)	Price (SEK)
	<b>MODESTY PANEL</b> White			1.314
	<b>MODESTY PANEL</b> Black			1.314
	<b>CHAIR SUSPENSION</b> Chair suspension for FourCast2 Four, FourCast2 Line, FourSure 44, FourSure 88, FourSure 11, FourSure 99, Four Stools, Four Seating Benches	0,3 Kg		255
	<b>CHAIR SUSPENSION</b> Chair suspension for FourCast2 Wheeler, FourSure 66	0,3 Kg		255
	<b>CABLE CUT OUT</b> Cable duct, aluminum. Cable duct placed in apron			2.030
	<b>CABLE CUT OUT</b>			711
	<b>LINKING DEVICE</b> Linking Device, set of 4 pcs - 2 x he, 2 x she per table			525
	<b>TABLE TROLLEY - 20100001</b> Trolley for 10 Folded Tables or 7 round tables, including strap	20 Kg	1720 mm x 550 mm x 980 mm. Folded Table: 150 mm	8.773



## FEATURES

- Table height 72,5 cm – integrated castors on two legs with height adjustment.
- With height adjustment glides on the other two legs to aid movement.
- Foldable by one person without the use of tools.
- Matching ABS edges. Powder coated frame options.
- Electrical units are optional and will be positioned in the centre of tables as standard.



For product information visit [oceefour.com](http://oceefour.com) ↗

## TABLE TOP

Decor



Laminate



Fenix laminate



Linoleum



## FRAME COLOURS

Standard



For electrical accessories [go to page 228](#) ↗

For full colour details [go to page 236](#) ↗

Product	Description (Item nr)	Weight (Kg)	Chair suspension	Dimensions (mm)	Top	Price (SEK)
	<b>120E0</b> Four® Eating, 80 x 80 with 80 x 70 frame, Folding legs	17.9	2		Decor Laminate Fenix laminate Linoleum	5.247 7.103 8.551 10.085
	<b>12000</b> Four® Eating, 120 x 80, Folding legs	23.4	4		Decor Laminate Fenix laminate Linoleum	7.104 8.116 10.265 11.630
	<b>12050</b> Four® Eating, 140 x 80, Folding legs	28.4	4		Decor Laminate Fenix laminate Linoleum	7.397 8.476 11.137 12.285
	<b>12040</b> Four® Eating, 160 x 80, Folding legs	31.4	4		Decor Laminate Fenix laminate Linoleum	7.672 9.048 11.984 12.741
	<b>12010</b> Four® Eating, 180 x 80, Folding legs	34.3	6		Decor Laminate Fenix laminate Linoleum	7.968 9.417 12.855 13.171

For tabletop cutout placements go to: [Oceedesign.com/Cutout.pdf](http://Oceedesign.com/Cutout.pdf)





# Four® Eating

Design by Strand+Hvass

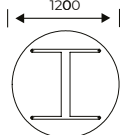
[Content ↗](#)

Product	Description (Item nr)	Weight (Kg)	Chair suspension	Dimensions (mm)	Top	Price (SEK)
	<b>12020</b> Four® Eating, Ø 120, Folding legs	24.9	2		Decor	7.735
					Laminate	9.017
					Fenix laminate	12.345
					Linoleum	13.861

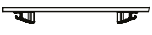
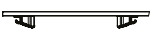
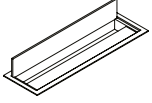
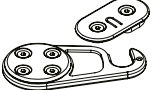
For tabletop cutout placements go to: [Oceadesign.com/Cutout.pdf](https://oceadesign.com/Cutout.pdf)

ACCESSORIES	Description	Weight (Kg)	Dimensions (mm)	Price (SEK)
	<b>CHAIR SUSPENSION</b> Chair suspension for FourCast2 Four, FourCast2 Line, FourSure 44, FourSure 88, FourSure 11, FourSure 99, Four Stools, Four Seating Benches	0,3 Kg		255
	<b>CHAIR SUSPENSION</b> Chair suspension for FourCast2 Wheeler, FourSure 66	0,3 Kg		255
	<b>CABLE CUT OUT</b> Cable duct, aluminum. Cable duct placed in apron			2.030
	<b>CABLE CUT OUT</b>			711
	<b>LINKING DEVICE</b> Linking Device, set of 4 pcs - 2 x he, 2 x she per table			525
	<b>TABLE TROLLEY - 20100001</b> Trolley for 10 Folded Tables or 7 round tables, including strap	20 Kg	1720 mm x 550 mm x 980 mm. Folded Table: 150 mm	8.773

# Four® Meeting

Design by Strand+Hvass

[Content ↗](#)



## FEATURES

- Table height 72,5 cm – integrated castors on two legs.
- With height adjustment glides on the other two legs to aid movement.
- Foldable by one person without the use of tools (thickness of folded table 15 cm).
- Matching ABS edges. Powder coated frame options.
- Electrical units are optional and will be positioned in the centre of tables as standard.



For product information visit [oceefour.com](http://oceefour.com) ↗

## TABLE TOP

## FRAME COLOURS

Standard

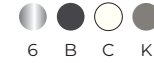

Laminate







Fenix laminate



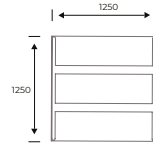

Linoleum

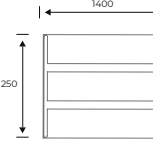

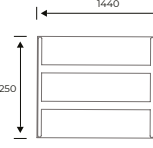
For full colour details [go to page 236](#) ↗

Product	Description (Item nr)	Weight (Kg)	Chair suspension	Dimensions (mm)	Top	Price (SEK)
	<b>11730</b> Four® Meeting, 125 x 125, Folding legs	42.1	4		Laminate Fenix laminate Linoleum	13.486 18.061 19.362
	<b>11750</b> Four® Meeting, 125 x 140, Folding legs	45.7	4		Laminate Fenix laminate Linoleum	14.218 18.602 19.881
	<b>11740</b> Four® Meeting, 125 x 144 D-shape, Folding legs	39.1	4		Laminate Fenix laminate Linoleum	14.797 19.077 20.317

For tabletop cutout placements go to: [Oceedesign.com/Cutout.pdf](http://Oceedesign.com/Cutout.pdf)

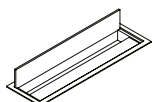
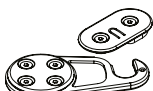
ACCESSORIES	Description	Weight (Kg)	Dimensions (mm)	Price (SEK)
	<b>CHAIR SUSPENSION</b> Chair suspension for FourCast2 Four, FourCast2 Line, FourSure 44, FourSure 88, FourSure 11, FourSure 99, Four Stools, Four Seating Benches	0,3 Kg		255
	<b>CHAIR SUSPENSION</b> Chair suspension for FourCast2 Wheeler, FourSure 66	0,3 Kg		255
	<b>CABLE CUT OUT</b> Cable duct, aluminum. Cable duct placed in apron			2.030
	<b>CABLE CUT OUT</b>			711
	<b>LINKING DEVICE</b> Linking Device, set of 4 pcs - 2 x he, 2 x she per table			525

# Four® Standing

Design by Strand+Hvass

[Content ↗](#)



## FEATURES

- Table height 90 & 103 cm
- Integrated castors on two legs
- Powder coated frame options
- Matching ABS edges

For product information visit [oceefour.com](https://oceefour.com) ↗

## TABLE TOP

Decor



Laminate



Fenix laminate



Linoleum



## FRAME COLOURS

Standard



For full colour details [go to page 236](#) ↗





Product	Description (Item nr)	Weight (Kg)	Dimensions (mm)	Top	Price (SEK)
	<b>12323</b> Four® Standing, 140 x 60, 90 cm	28.2		Decor Laminate Fenix laminate Linoleum	12.429 13.446 16.095 18.294
	<b>12383</b> Four® Standing, 140 x 80, 90 cm	36.7		Decor Laminate Fenix laminate Linoleum	13.775 15.065 18.726 20.136
	<b>12313</b> Four® Standing, 180 x 60, 90 cm	35.1		Decor Laminate Fenix laminate Linoleum	12.696 14.069 18.420 19.055
	<b>12393</b> Four® Standing, 180 x 80, 90 cm	43.1		Decor Laminate Fenix laminate Linoleum	14.069 15.815 20.403 20.815
	<b>12322</b> Four® Standing, 140 x 60, 103 cm	29.1		Decor Laminate Fenix laminate Linoleum	12.429 13.446 16.095 18.294

For tabletop cutout placements go to: [Oceedesign.com/Cutout.pdf](https://Oceedesign.com/Cutout.pdf)

# Four® Standing

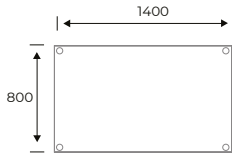
Design by Strand+Hvass

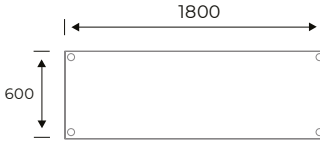
[Content ↗](#)

Product	Description (Item nr)	Weight (Kg)	Dimensions (mm)	Top	Price (SEK)
	<b>12382</b> Four® Standing, 140 x 80, 103 cm	37.6		Decor	13.775
				Laminate	15.065
				Fenix laminate	18.726
				Linoleum	20.136
	<b>12312</b> Four® Standing, 180 x 60, 103 cm	35.9		Decor	12.696
				Laminate	14.069
				Fenix laminate	18.420
				Linoleum	19.055
	<b>12392</b> Four® Standing, 180 x 80, 103 cm	44		Decor	14.069
				Laminate	15.815
				Fenix laminate	20.403
				Linoleum	20.815

For tabletop cutout placements go to: [Oceedesign.com/Cutout.pdf](https://Oceedesign.com/Cutout.pdf)







## FEATURES

- Table height 51, 64, 72 & 103 cm
- Aluminium pedestal 4 and 5-star base
- Castors to table height 51 cm, 64 cm and 72 cm + 5 cm. in height.
- Matching ABS edges
- Powder coated frame options

For product information visit [oceefour.com](http://oceefour.com) ↗

### TABLE TOP

Decor



Laminate



Fenix laminate



Linoleum



### FRAME COLOURS

Standard



Frame optional\*



For full colour details [go to page 236](#) ↗

Product	Description (Item nr)	Weight (Kg)	Dimensions (mm)	Top	Price (SEK)
	<b>12240</b> Four® Resting, Ø 60, 51 cm - 4 Star base	9.3	 Ø 600	Decor	5.103
				Laminate	6.128
				Fenix laminate	7.325
				Linoleum	8.277
	<b>12243</b> Four® Resting, Ø 60, 64 cm - 4 Star base	9.6	 Ø 600	Decor	5.336
				Laminate	6.370
				Fenix laminate	7.555
				Linoleum	8.518
	<b>12241</b> Four® Resting, Ø 60, 72,5 cm - 4 Star base	9.9	 Ø 600	Decor	5.336
				Laminate	6.370
				Fenix laminate	7.555
				Linoleum	8.518
	<b>12242</b> Four® Resting, Ø 60, 103 cm - 4 Star base	10.7	 Ø 600	Decor	5.528
				Laminate	6.559
				Fenix laminate	7.743
				Linoleum	8.718
	<b>12250</b> Four® Resting, Ø 70, 51 cm - 4 Star base	10.9	 Ø 700	Decor	5.214
				Laminate	6.450
				Fenix laminate	7.937
				Linoleum	8.960











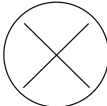

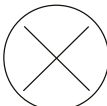







For tabletop cutout placements go to: [Ocedesign.com/Cutout.pdf](http://Ocedesign.com/Cutout.pdf)

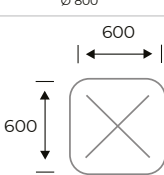

# Four® Resting

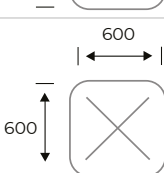
Design by Strand+Hvass

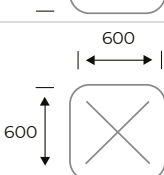
[Content ↗](#)

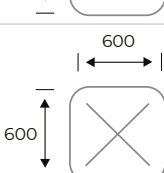
Product	Description (Item nr)	Weight (Kg)	Dimensions (mm)	Top	Price (SEK)
	<b>12253</b> Four® Resting, Ø 70, 64 cm - 4 Star base	11.2	 Ø 700	Decor	5.466
				Laminate	6.669
				Fenix laminate	8.158
				Linoleum	9.194
	<b>12251</b> Four® Resting, Ø 70, 72,5 cm - 4 Star base	11.4	 Ø 700	Decor	5.466
				Laminate	6.669
				Fenix laminate	8.158
				Linoleum	9.194
	<b>12252</b> Four® Resting, Ø 70, 103 cm - 4 Star base	12.2	 Ø 700	Decor	5.647
				Laminate	6.871
				Fenix laminate	8.349
				Linoleum	9.384
	<b>12265</b> Four® Resting, Ø 80, 51 cm - 5 Star base	12.9	 Ø 800	Decor	5.365
				Laminate	6.792
				Fenix laminate	8.607
				Linoleum	9.323
	<b>12268</b> Four® Resting, Ø 80, 64 cm - 5 Star base	13.2	 Ø 800	Decor	5.594
				Laminate	7.025
				Fenix laminate	8.830
				Linoleum	9.545
	<b>12266</b> Four® Resting, Ø 80, 72,5 cm - 5 Star base	13.4	 Ø 800	Decor	5.594
				Laminate	7.025
				Fenix laminate	8.830
				Linoleum	9.545
	<b>12267</b> Four® Resting, Ø 80, 103 cm - 5 Star base	14.2	 Ø 800	Decor	5.807
				Laminate	7.212
				Fenix laminate	9.029
				Linoleum	9.747
	<b>12230</b> Four® Resting, 60 x 60, 51 cm - 4 Star base	-		Decor	5.103
				Laminate	6.128
				Fenix laminate	7.325
				Linoleum	8.277
	<b>12233</b> Four® Resting, 60 x 60, 64 cm - 4 Star base	10.7		Decor	5.336
				Laminate	6.370
				Fenix laminate	7.555
				Linoleum	8.518
	<b>12231</b> Four® Resting, 60 x 60, 72,5 cm - 4 Star base	11		Decor	5.336
				Laminate	6.370
				Fenix laminate	7.555
				Linoleum	8.518
	<b>12232</b> Four® Resting, 60 x 60, 103 cm - 4 Star base	11.8		Decor	5.528
				Laminate	6.559
				Fenix laminate	7.743
				Linoleum	8.718

For tabletop cutout placements go to: [Oceedesign.com/Cutout.pdf](https://oceedesign.com/Cutout.pdf)

# Four® Resting

Design by Strand+Hvass

[Content](#) ↗

Product	Description (Item nr)	Weight (Kg)	Dimensions (mm)	Top	Price (SEK)
	<b>12200</b> Four® Resting, 70 x 70, 51 cm - 4 Star base	-		Decor	5.214
				Laminate	6.450
				Fenix laminate	7.937
				Linoleum	8.960
	<b>12203</b> Four® Resting, 70 x 70, 64 cm - 4 Star base	-		Decor	5.466
				Laminate	6.669
				Fenix laminate	8.158
				Linoleum	9.194
	<b>12201</b> Four® Resting, 70 x 70, 72,5 cm - 4 Star base	13		Decor	5.466
				Laminate	6.669
				Fenix laminate	8.158
				Linoleum	9.194
	<b>12202</b> Four® Resting, 70 x 70, 103 cm - 4 Star base	13.8		Decor	5.647
				Laminate	6.871
				Fenix laminate	8.349
				Linoleum	9.384
	<b>12215</b> Four® Resting, 80 x 80, 51 cm - 5 Star base	15		Decor	5.365
				Laminate	6.792
				Fenix laminate	8.607
				Linoleum	9.323
	<b>12218</b> Four® Resting, 80 x 80, 64 cm - 5 Star base	15.2		Decor	5.594
				Laminate	7.025
				Fenix laminate	8.830
				Linoleum	9.545
	<b>12216</b> Four® Resting, 80 x 80, 72,5 cm - 5 Star base	15.5		Decor	5.594
				Laminate	7.025
				Fenix laminate	8.830
				Linoleum	9.545
	<b>12217</b> Four® Resting, 80 x 80, 103 cm - 5 Star base	16.3		Decor	5.807
				Laminate	7.212
				Fenix laminate	9.029
				Linoleum	9.747
	<b>12220</b> Four® Resting, 80 x 60, 51 cm - 4 Star base	12.3		Decor	5.214
				Laminate	6.450
				Fenix laminate	7.925
				Linoleum	8.578
	<b>12223</b> Four® Resting, 80 x 60, 64 cm - 4 Star base	12.6		Decor	5.466
				Laminate	6.669
				Fenix laminate	8.146
				Linoleum	8.821
	<b>12221</b> Four® Resting, 80 x 60, 72,5 cm - 4 Star base	12.8		Decor	5.466
				Laminate	6.669
				Fenix laminate	8.146
				Linoleum	8.821

For tabletop cutout placements go to: [Ocedesign.com/Cutout.pdf](https://Ocedesign.com/Cutout.pdf)

# Four® Resting

Design by Strand+Hvass

[Content ↗](#)

Product	Description (Item nr)	Weight (Kg)	Dimensions (mm)	Top	Price (SEK)
	<b>12222</b> Four® Resting, 80 x 60, 103 cm - 4 Star base	-		Decor	5.655
				Laminate	6.861
				Fenix laminate	8.357
				Linoleum	9.001

For tabletop cutout placements go to: [Oceedesign.com/Cutout.pdf](https://oceedesign.com/Cutout.pdf)

ACCESSORIES	Description	Weight (Kg)	Dimensions (mm)	Price (SEK)
	<b>CHAIR FEET</b> Castors			651
	<b>CHAIR FEET</b> Felt glides, set of 4 pcs. height + 0,2 cm	1,82 g x 4		208
	<b>FLIP TOP</b> With Flip Top			2.730

SURCHARGE		Price (SEK)
<b>FRAME OPTIONAL</b>	 B C K	1075

# Y-Table

Design by Osko + Deichmann

[Content ↗](#)



## FEATURES

- Height adjustable
- Fold-away allows for nesting storage
- Designed for disassembly at end of life
- Cable management hook
- Height lever doubles up as a handle for portability
- Designed to complement products across all our families
- Tested according to EN 16139, L2 and EN15372 for stability

For product information visit [oceefour.com](https://oceefour.com) ↗

## TABLE TOP

Fenix laminate



09

## FRAME COLOURS

Standard



B

For full colour details [go to page 236](#) ↗

Product	Description (Item nr)	Weight (Kg)	Dimensions (mm)	Top	Price (SEK)
	<b>ATYT63</b> Y-Table, 46 cm x 33 cm	4.6		Fenix laminate	4.103





FourPeople Stand Alone



FourPeople Stand Alone for panels



FourPeople Modules



FourPeople Modules for panels



FourPeople Stand alone panels



FourPeople Add on panels



FourPeople Work Booth



FourPeople Study Booth



FourPeople Work Hut



FourPeople Sofa Hut

# FourPeople Stand Alone

Design by Nørgaard Design

[Content ↗](#)

## Configuration Example 1

2 seater  
Low back with armrest



1 seater  
Low back



2 seater  
Low back



3 seater  
Low back



Pouf



# FourPeople Stand Alone

Design by Nørgaard Design

[Content ↗](#)



## FEATURES



- Soft seating range with low back and high back options.
- The range includes one, two, three seater sofas and Pouffe.
- Two tone fabric options available & armrest option.
- Electrical units are optional and will be positioned on the left or right side of sofas as standard.
- Leg and frame in black (RAL7021).
- Upholstery available in various fabrics. For recommendations, please contact your sales representative.

For product information visit [oceefour.com](https://oceefour.com) ↗

For electrical accessories [go to page 228](#) ↗





For full band and colour details [go to page 338](#) ↗

Product	Description (Item nr)	Weight (Kg)	Dimensions (mm)	Band	Same colour (SEK)	Different seat colour (SEK)
	<b>PEF1L</b> FourPeople Stand Alone, 1 Seater, Low back			1 2 3 4 5 6 7	12.040 12.490 12.962 13.983 14.455 14.807 16.021	2.409 2.498 2.592 2.796 2.891 2.962 3.205
	<b>PEF1H</b> FourPeople Stand Alone, 1 Seater, High back			1 2 3 4 5 6 7	13.861 14.407 14.990 16.264 16.847 17.284 18.788	2.409 2.498 2.592 2.796 2.891 2.962 3.474
	<b>PEF2L</b> FourPeople Stand Alone, 2 Seater, Low back			1 2 3 4 5 6 7	18.885 19.225 19.809 21.083 21.665 22.102 23.607	3.777 3.846 3.962 4.217 4.333 4.421 4.722
	<b>PEF2H</b> FourPeople Stand Alone, 2 Seater, High back			1 2 3 4 5 6 7	21.629 22.539 23.510 25.610 26.580 27.296 29.773	3.777 3.846 3.962 4.217 4.333 4.421 4.722

# FourPeople Stand Alone

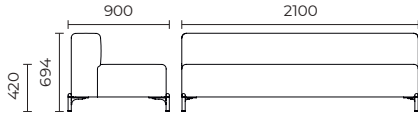
[Content ↗](#)

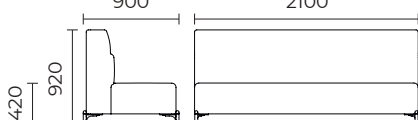
Design by Nørgaard Design

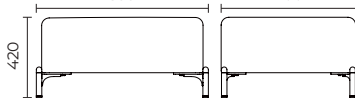
Product	Description (Item nr)	Weight (Kg)	Dimensions (mm)	Band	Same colour (SEK)	Different seat colour (SEK)
	<b>PEF3L</b> FourPeople Stand Alone, 3 Seater, Low back			1 2 3 4 5 6 7	26.957 27.976 29.057 31.399 32.479 33.280 36.047	5.392 5.595 5.811 6.280 6.496 6.657 7.210
	<b>PEF3H</b> FourPeople Stand Alone, 3 Seater, High back			1 2 3 4 5 6 7	31.242 32.491 33.827 36.703 38.025 39.009 42.420	5.392 5.595 5.811 6.280 6.496 6.657 7.210
	<b>PEFP0</b> FourPeople Stand Alone, Pouf			1 2 3 4 5 6 7	9.795 10.147 10.535 11.361 11.748 12.028 13.011	

ACCESSORIES	Description	Weight (Kg)	Dimensions (mm)	Band	Price (SEK)
	Set of armrests		800 x 486 x 134 mm	1 2 3 4 5 6 7	3.568 4.170 4.825 6.209 6.847 7.318 8.976
	<b>FOURPEOPLE TRAY ACC1002</b>	1,8 kg			478



# FourPeople Stand Alone for Panels

[Content ↗](#)

Design by Nørgaard Design

## Configuration Example 1

2 seater low back with  
back panel with straps,  
H1020



1 seater  
Low back



2 seater  
Low back



3 seater  
Low back

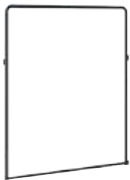

Open Panel

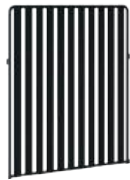

Panel with straps



Panel with fabric



Panel Fabric  
with Acoustic

# FourPeople Stand Alone for panels

[Content ↗](#)

Design by Nørgaard Design



## FEATURES





- Soft seating range with panels. The range includes one, two and three seater sofas.
- Two tone fabric options available.
- A wide selection of panels in a range of heights and widths.
- Panel Options: Open panel, Panel with straps, Fabric Panel, Fabric Panel with Acoustic Filling.
- Armrest option (cannot combine armrest and side panels on the same side).
- Electrical units are optional and will be positioned on the left or right side of sofas as standard.
- Upholstery available in various fabrics. For recommendations, please contact your sales representative.

For product information visit [oceefour.com](https://oceefour.com) ↗

For electrical accessories [go to page 228](#) ↗

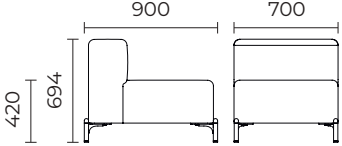
For full band and colour details [go to page 238](#) ↗

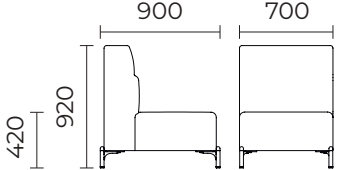

Product	Description (Item nr)	Weight (Kg)	Dimensions (mm)	Band	Same colour (SEK)	Different seat colour (SEK)
	<b>PEE1L</b> FourPeople Stand Alone for back panel, 1 Seater, Low back			1 2 3 4 5 6 7	12.040 12.490 12.962 13.983 14.455 14.807 16.021	2.409 2.498 2.592 2.796 2.891 2.962 3.205
	<b>PEE1H</b> FourPeople Stand Alone for back panel, 1 Seater, High back			1 2 3 4 5 6 7	13.861 14.407 14.990 16.264 16.847 17.284 18.788	2.409 2.498 2.592 2.796 2.891 2.962 3.474

# FourPeople Stand Alone for panels

Content ↗

Design by Nørgaard Design

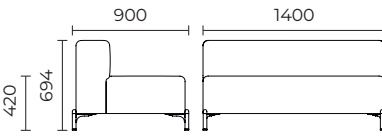
SURCHARGE	Open panel		Panel / Straps		Panel / Fabric			Acoustic		Armrest
	Back	1 x Side	Back	1 x Side	Band	Back	1 x Side	Back	1 x Side	1 x
H: 1020	3.447	4.224	4.321	5.390	1	4.006	4.928	4.905	6.129	1.784
					2	4.346	5.353	5.244	6.554	2.085
					3	4.710	5.802	5.609	7.003	2.413
					4	5.487	6.784	6.385	7.985	3.105
					5	5.851	7.233	6.750	8.435	3.424
					6	6.117	7.561	7.016	8.762	3.659
					7	7.040	8.714	7.939	9.916	4.488
H: 1370	5.692	6.579	6.590	7.780	1	6.264	7.283	7.477	8.618	1.784
					2	6.603	7.709	7.817	9.044	2.085
					3	6.955	8.157	8.169	9.492	2.413
					4	7.744	9.140	8.958	10.476	3.105
					5	8.096	9.590	9.310	10.925	3.424
					6	8.364	9.917	9.577	11.253	3.659
					7	9.285	11.070	10.499	12.406	4.488
H: 1720	5.936	6.676	6.870	7.805	1	6.750	7.624	9.080	9.954	1.784
					2	7.235	8.266	9.565	10.596	2.085
					3	7.757	8.933	10.087	11.264	2.413
					4	8.873	10.403	11.203	12.733	3.105
					5	9.395	11.070	11.725	13.400	3.424
					6	9.772	11.580	12.102	13.910	3.659
					7	11.106	13.303	13.436	15.633	4.488

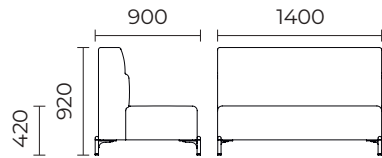
Product	Description (Item nr)	Weight (Kg)	Dimensions (mm)	Band	Same colour (SEK)	Different seat colour (SEK)
	<b>PEE2L</b> FourPeople Stand Alone for back panel, 2 Seater, Low back			1	18.885	3.777
				2	19.225	3.846
				3	19.809	3.962
				4	21.083	4.217
				5	21.665	4.333
				6	22.102	4.421
				7	23.607	4.722
	<b>PEE2H</b> FourPeople Stand Alone for back panel, 2 Seater, High back			1	21.629	3.777
				2	22.539	3.846
				3	23.510	3.962
				4	25.610	4.217
				5	26.580	4.333
				6	27.296	4.421
				7	29.773	4.722



SURCHARGE	Open panel		Panel / Straps		Panel / Fabric			Acoustic		Armrest
	Back	1 x Side	Back	1 x Side	Band	Back	1 x Side	Back	1 x Side	1 x
H: 1020	3.994	4.224	5.936	5.390	1	5.014	4.929	7.332	6.131	1.784
					2	5.633	5.354	7.951	6.555	2.085
					3	6.288	5.803	8.606	7.005	2.413
					4	7.696	6.785	10.014	7.987	3.105
					5	8.351	7.235	10.669	8.436	3.424
					6	8.837	7.562	11.155	8.764	3.659
					7	10.511	8.716	12.829	9.917	4.488
H: 1370	6.410	6.580	8.351	7.781	1	7.442	7.283	9.796	8.618	1.784
					2	8.048	7.709	10.403	9.044	2.085
					3	8.703	8.157	11.058	9.492	2.413
					4	10.111	9.140	12.466	10.476	3.105
					5	10.766	9.590	13.121	10.925	3.424
					6	11.253	9.917	13.607	11.253	3.659
					7	12.927	11.070	15.281	12.406	4.488
H: 1720	6.676	6.676	8.703	7.805	1	8.206	7.624	12.733	9.954	1.784
					2	9.116	8.266	13.643	10.596	2.085
					3	10.074	8.933	14.602	11.264	2.413
					4	12.174	10.403	16.702	12.733	3.105
					5	13.144	11.070	17.672	13.400	3.424
					6	13.861	11.580	18.388	13.910	3.659
					7	16.348	13.303	20.876	15.633	4.488



# FourPeople Stand Alone for panels

[Content ↗](#)

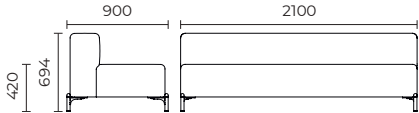
Design by Nørgaard Design

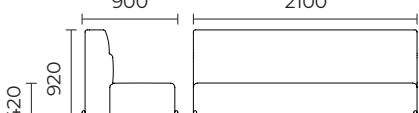
Product	Description (Item nr)	Weight (Kg)	Dimensions (mm)	Band	Same colour (SEK)	Different seat colour (SEK)
	<b>PEE3L</b> FourPeople Stand Alone for back panel, 3 Seater, Low back			1	26.957	5.392
				2	27.976	5.595
				3	29.057	5.811
				4	31.399	6.280
				5	32.479	6.496
				6	33.280	6.657
				7	36.047	7.210
	<b>PEE3H</b> FourPeople Stand Alone for back panel, 3 Seater, High back			1	31.242	5.392
				2	32.491	5.595
				3	33.827	5.811
				4	36.703	6.280
				5	38.025	6.496
				6	39.009	6.657
				7	42.420	7.210

SURCHARGE	Open panel		Panel / Straps		Panel / Fabric			Acoustic		Armrest
	Panel height	Back	1 x Side	Back	1 x Side	Band	Back	1 x Side	Back	1 x Side
H: 1020	4.322	4.225	8.121	5.390	1	6.725	4.929	9.310	6.131	1.784
					2	7.635	5.354	10.220	6.555	2.085
					3	8.594	5.803	11.179	7.005	2.413
					4	10.694	6.785	13.279	7.987	3.105
					5	11.665	7.235	14.250	8.436	3.424
					6	12.381	7.562	14.966	8.764	3.659
					7	14.869	8.716	17.454	9.917	4.488
H: 1370	7.539	6.580	10.524	7.781	1	9.055	7.283	13.618	8.618	1.784
					2	9.966	7.709	14.529	9.044	2.085
					3	10.924	8.157	15.487	9.492	2.413
					4	13.024	9.140	17.587	10.476	3.105
					5	13.995	9.590	18.558	10.925	3.424
					6	14.711	9.917	19.274	11.253	3.659
					7	17.199	11.070	21.762	12.406	4.488
H: 1720	4.147	6.676	10.646	7.805	1	9.796	7.624	14.409	9.954	1.784
					2	11.155	8.266	15.768	10.596	2.085
					3	12.587	8.933	17.199	11.264	2.413
					4	15.706	10.403	20.318	12.733	3.105
					5	17.151	11.070	21.764	13.400	3.424
					6	18.218	11.580	22.831	13.910	3.659
					7	21.921	13.303	26.533	15.633	4.488

ACCESSORIES	Description	Weight (Kg)	Dimensions (mm)	Band	Price (SEK)
	<b>FOURPEOPLE TRAY ACC1002</b>	1,8 kg			478
	<b>FOURPEOPLE HOOK ACC1001</b>	0,1 kg			126



# FourPeople Modules

Design by Nørgaard Design



## Configuration Example 1

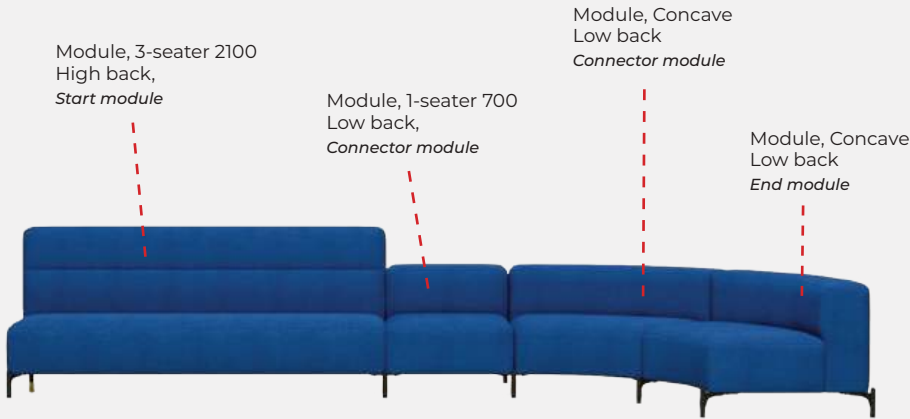

## Modules overview

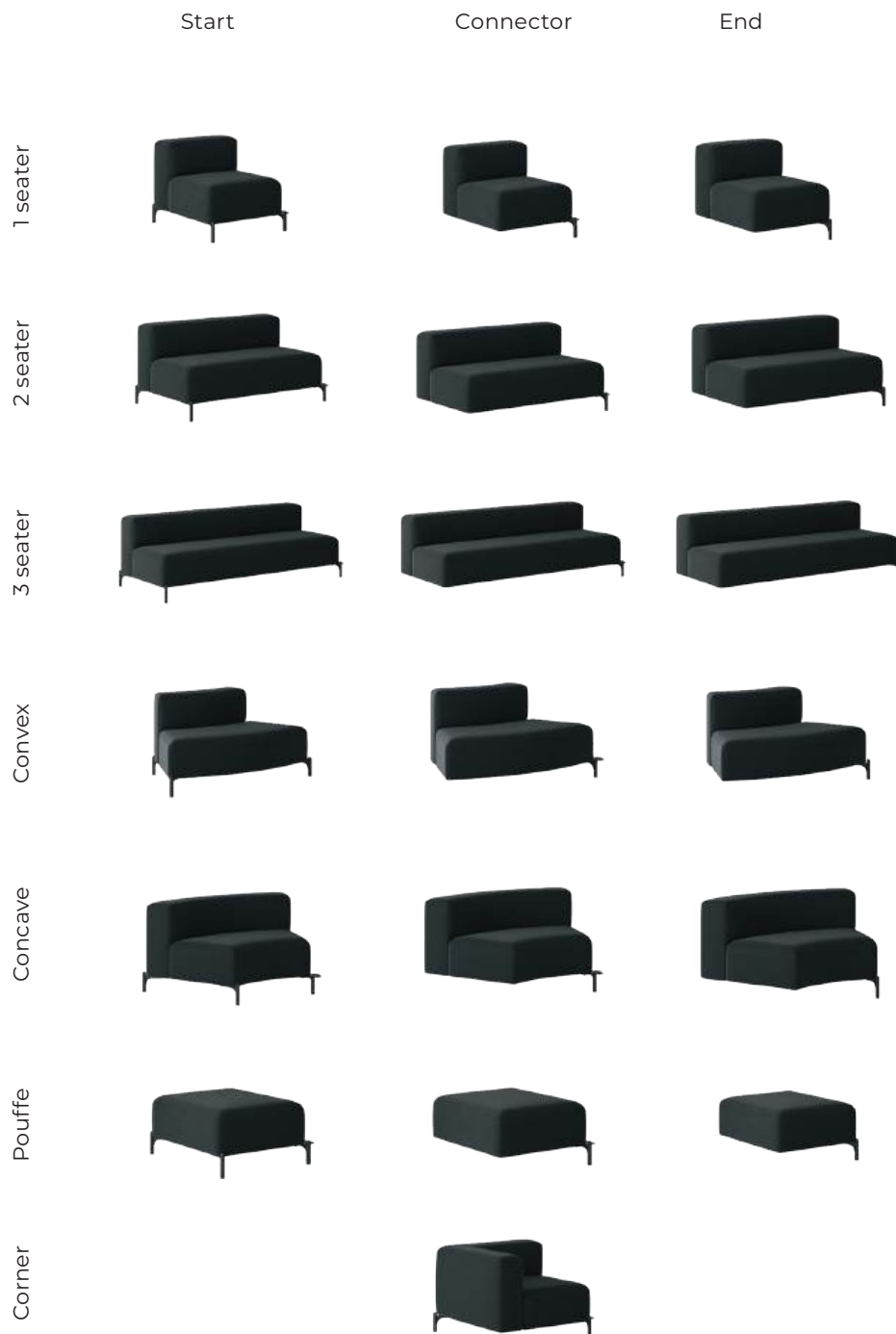

# FourPeople Modules

Design by Nørgaard Design

[Content ↗](#)



## FEATURES







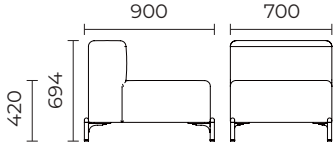

- Multifunctional modular soft seating range.
- The range includes one, two & three seater modules; convex, concave & corner modules; and pouffe.
- The price is the same if it's a start, connector or an end module.
- Two tone fabric options available & armrest option.
- Electrical units are optional and will be positioned on the left or right side of sofas as standard.
- Leg and frame in black (RAL7021).
- Upholstery available in various fabrics. For recommendations, please contact your sales representative.

For product information visit [oceefour.com](http://oceefour.com) ↗

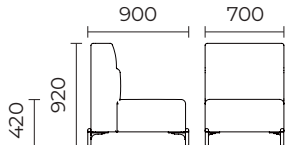
For electrical accessories [go to page 228](#) ↗

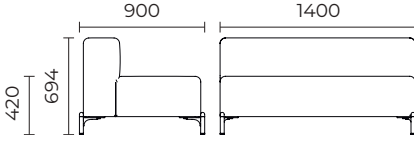

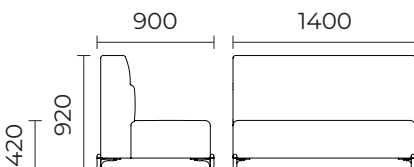







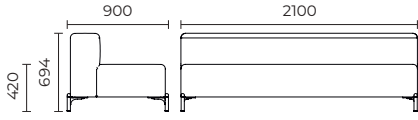

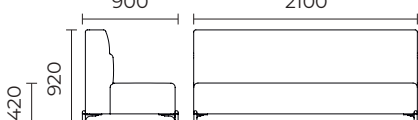

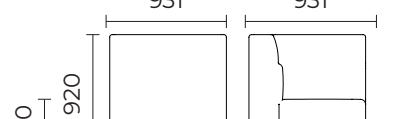

For full band and colour details [go to page 238](#) ↗

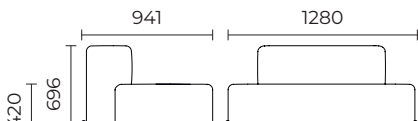
Product	Description (Item nr)	Weight (Kg)	Dimensions (mm)	Band	Same colour (SEK)	Different seat colour (SEK)
	<b>PEC1</b> FourPeople Modules - Low back, 1 Seater			1 2 3 4 5 6 7	12.040 12.490 12.962 13.983 14.455 14.807 16.021	2.409 2.498 2.592 2.796 2.891 2.962 3.205
	<b>PED1</b> FourPeople Modules - High back, 1 Seater			1 2 3 4 5 6 7	13.861 14.407 14.990 16.264 16.847 17.284 18.788	2.409 2.498 2.592 2.796 2.891 2.962 3.474
	<b>PEC2</b> FourPeople Modules - Low back, 2 Seater			1 2 3 4 5 6 7	18.885 19.225 19.809 21.083 21.665 22.102 23.607	3.777 3.846 3.962 4.217 4.333 4.421 4.722
	<b>PED2</b> FourPeople Modules - High back, 2 Seater			1 2 3 4 5 6 7	21.629 22.539 23.510 25.610 26.580 27.296 29.773	3.777 3.846 3.962 4.217 4.333 4.421 4.722

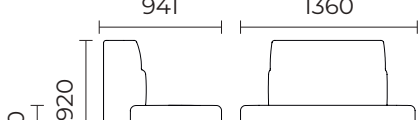
# FourPeople Modules

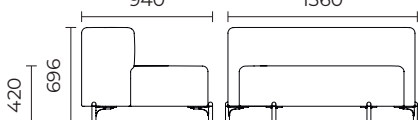
[Content](#) ↗

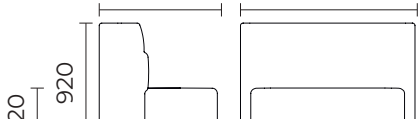
Design by Nørgaard Design

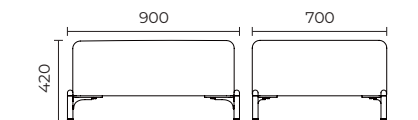
Product	Description (Item nr)	Weight (Kg)	Dimensions (mm)	Band	Same colour (SEK)	Different seat colour (SEK)
	<b>PEC3</b> FourPeople Modules - Low back, 3 Seater			1 2 3 4 5 6 7	26.957 27.976 29.057 31.399 32.479 33.280 36.047	5.392 5.595 5.811 6.280 6.496 6.657 7.210
	<b>PED3</b> FourPeople Modules - High back, 3 Seater			1 2 3 4 5 6 7	31.242 32.491 33.827 36.703 38.025 39.009 42.420	5.392 5.595 5.811 6.280 6.496 6.657 7.210
	<b>PECC</b> FourPeople Modules - Low back, Corner 90°			1 2 3 4 5 6 7	18.303 19.032 19.796 21.447 22.211 22.783 24.748	3.661 3.807 3.959 4.290 4.443 4.557 4.950
	<b>PEDC</b> FourPeople Modules - High back, Corner 90°			1 2 3 4 5 6 7	22.394 23.365 24.396 26.642 27.673 28.450 31.109	3.661 3.807 3.959 4.290 4.443 4.557 4.950
	<b>PECV</b> FourPeople Modules - Low back, Convex			1 2 3 4 5 6 7	18.485 19.080 19.711 21.070 21.702 22.176 23.790	3.698 3.817 3.943 4.214 4.340 4.436 4.758
	<b>PEDV</b> FourPeople Modules - High back, Convex			1 2 3 4 5 6 7	21.035 21.884 22.783 24.736 25.635 26.302 28.614	3.698 3.817 3.943 4.214 4.340 4.436 4.758
	<b>PECA</b> FourPeople Modules - Low back, Concave			1 2 3 4 5 6 7	19.190 19.888 20.633 22.242 22.983 23.535 25.440	3.839 3.979 4.127 4.448 4.596 4.707 5.088
	<b>PEDA</b> FourPeople Modules - High back, Concave			1 2 3 4 5 6 7	22.795 23.668 24.591 26.587 27.510 28.195 30.562	3.839 3.979 4.127 4.448 4.596 4.707 5.088
	<b>PECP</b> FourPeople Modules - Low back, Pouf			1 2 3 4 5 6 7	9.795 10.147 10.535 11.361 11.748 12.028 13.011	

# FourPeople Modules

Design by Nørgaard Design

[Content ↗](#)

ACCESSORIES	Description	Weight (Kg)	Dimensions (mm)	Band	Price (SEK)
	armrest		800 x 486 x 134 mm	1	1.784
				2	2.085
				3	2.413
				4	3.105
				5	3.424
				6	3.659
				7	4.488
	<b>FOURPEOPLE TRAY ACC1002</b>	1,8 kg			478





# FourPeople Modules for Panels

Design by Nørgaard Design

[Content ↗](#)

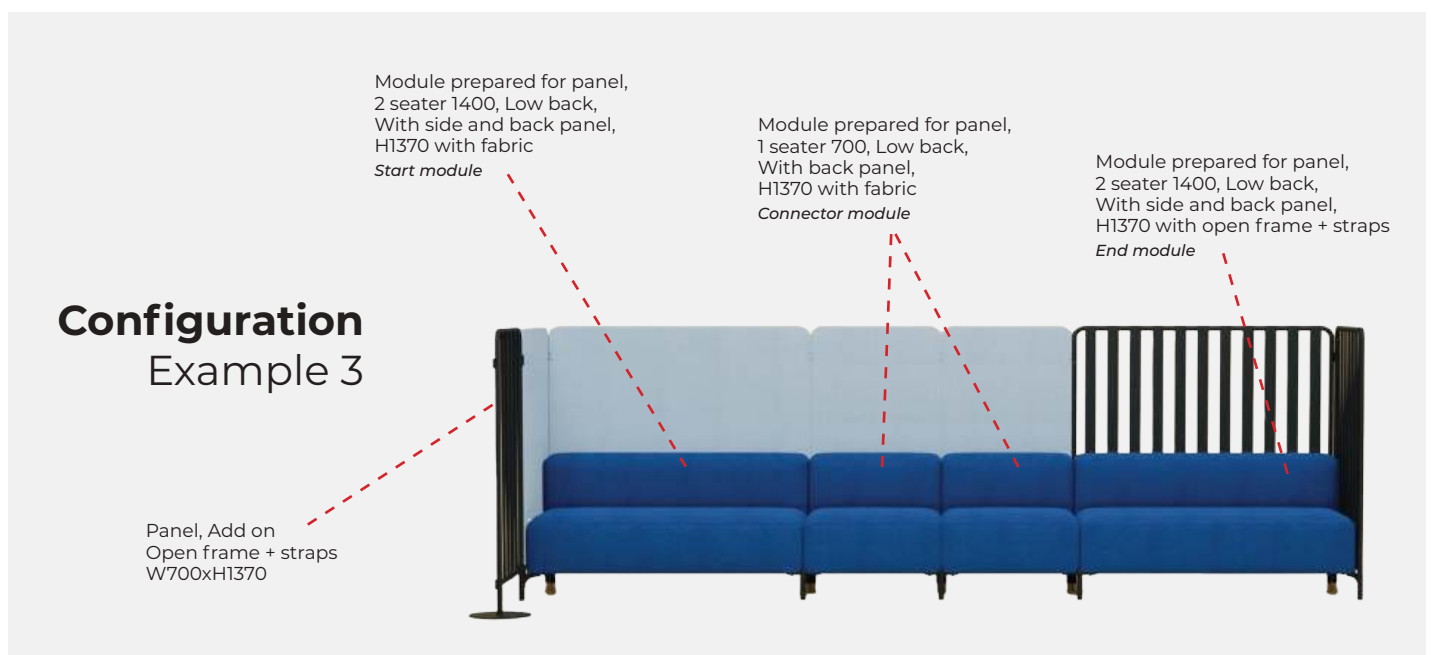



## Modules overview

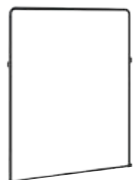

Open Panel

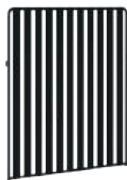

Panel with straps



Panel with fabric



Panel Fabric with Acoustic

# FourPeople Modules for panels

Design by Nørgaard Design

[Content ↗](#)



## FEATURES





- Multifunctional modular soft seating range with panels. As a standard, modules with or without panels cannot be connected.
- All modules can have panels on the back and side at the same time. Modules cannot have just a side panel. (two sides available for start module).
- The price is the same if it's a start, connector or an end module.
- Panel Options: Open panel, Panel with straps, Fabric Panel, Fabric Panel with Acoustic Filling.
- Armrest option (cannot combine armrest and side panels on the same side).
- Two tone fabric options available.
- Electrical units are optional and will be positioned on the left or right side of sofas as standard.
- Leg and frame in black (RAL7021).
- Upholstery available in various fabrics. For recommendations, please contact your sales representative.

For product information visit [oceefour.com](https://oceefour.com) ↗

For electrical accessories [go to page 228](#) ↗

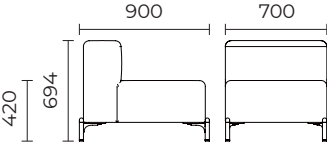
For full band and colour details [go to page 238](#) ↗

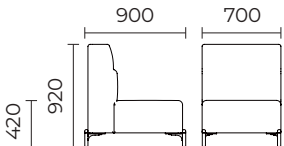

Product	Description (Item nr)	Weight (Kg)	Dimensions (mm)	Band	Same colour (SEK)	Different seat colour (SEK)
	<b>PEA1</b> FourPeople Modules low back for back panel, 1 Seater			1 2 3 4 5 6 7	12.040 12.490 12.962 13.983 14.455 14.807 16.021	2.409 2.498 2.592 2.796 2.891 2.962 3.205
	<b>PEB1</b> FourPeople Modules high back for back panel, 1 Seater			1 2 3 4 5 6 7	13.861 14.407 14.990 16.264 16.847 17.284 18.788	2.409 2.498 2.592 2.796 2.891 2.962 3.474

# FourPeople Modules for panels

[Content](#) ↗

Design by Nørgaard Design

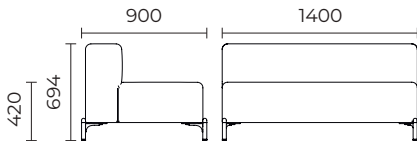
SURCHARGE	Open panel		Panel / Straps		Panel / Fabric			Acoustic		Armrest
	Panel height	Back	1 x Side	Back	1 x Side	Band	Back	1 x Side	Back	1 x Side
H: 1020	3.447	4.224	4.321	5.390	1	4.006	4.929	4.905	6.131	1.784
					2	4.346	5.354	5.244	6.555	2.085
					3	4.710	5.803	5.609	7.005	2.413
					4	5.487	6.785	6.385	7.987	3.105
					5	5.851	7.235	6.750	8.436	3.424
					6	6.117	7.562	7.016	8.764	3.659
					7	7.040	8.716	7.939	9.917	4.488
H: 1370	5.694	6.580	6.591	7.781	1	6.264	7.283	7.477	8.618	1.784
					2	6.603	7.709	7.817	9.044	2.085
					3	6.955	8.157	8.169	9.492	2.413
					4	7.744	9.140	8.958	10.476	3.105
					5	8.096	9.590	9.310	10.925	3.424
					6	8.364	9.917	9.577	11.253	3.659
					7	9.285	11.070	10.499	12.406	4.488
H: 1720	5.936	6.676	6.870	7.805	1	6.750	7.624	9.080	9.954	1.784
					2	7.235	8.266	9.565	10.596	2.085
					3	7.757	8.933	10.087	11.264	2.413
					4	8.873	10.403	11.203	12.733	3.105
					5	9.395	11.070	11.725	13.400	3.424
					6	9.772	11.580	12.102	13.910	3.659
					7	11.106	13.303	13.436	15.633	4.488

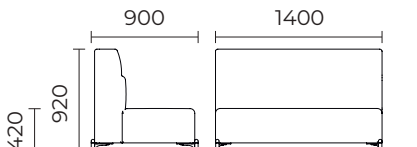

Product	Description (Item nr)	Weight (Kg)	Dimensions (mm)	Band	Same colour (SEK)	Different seat colour (SEK)
	<b>PEA2</b> FourPeople Modules low back for back panel, 2 Seater			1	18.885	3.777
				2	19.225	3.846
				3	19.809	3.962
				4	21.083	4.217
				5	21.665	4.333
				6	22.102	4.421
				7	23.607	4.722
	<b>PEB2</b> FourPeople Modules high back for back panel, 2 Seater			1	21.629	3.777
				2	22.539	3.846
				3	23.510	3.962
				4	25.610	4.217
				5	26.580	4.333
				6	27.296	4.421
				7	29.773	4.722

SURCHARGE	Open panel		Panel / Straps		Panel / Fabric			Acoustic		Armrest
	Panel height	Back	1 x Side	Back	1 x Side	Band	Back	1 x Side	Back	1 x Side
H: 1020	3.994	4.224	5.936	5.390	1	5.014	4.929	7.332	6.131	1.784
					2	5.633	5.354	7.951	6.555	2.085
					3	6.288	5.803	8.606	7.005	2.413
					4	7.696	6.785	10.014	7.987	3.105
					5	8.351	7.235	10.669	8.436	3.424
					6	8.837	7.562	11.155	8.764	3.659
					7	10.511	8.716	12.829	9.917	4.488
H: 1370	6.410	6.580	8.351	7.781	1	7.442	7.283	9.796	8.618	1.784
					2	8.048	7.709	10.403	9.044	2.085
					3	8.703	8.157	11.058	9.492	2.413
					4	10.111	9.140	12.466	10.476	3.105
					5	10.766	9.590	13.121	10.925	3.424
					6	11.253	9.917	13.607	11.253	3.659
					7	12.927	11.070	15.281	12.406	4.488
H: 1720	6.676	6.676	8.703	7.805	1	8.206	7.624	12.733	9.954	1.784
					2	9.116	8.266	13.643	10.596	2.085
					3	10.074	8.933	14.602	11.264	2.413
					4	12.174	10.403	16.702	12.733	3.105
					5	13.144	11.070	17.672	13.400	3.424
					6	13.861	11.580	18.388	13.910	3.659
					7	16.348	13.303	20.876	15.633	4.488

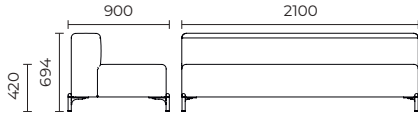

# FourPeople Modules for panels

[Content ↗](#)

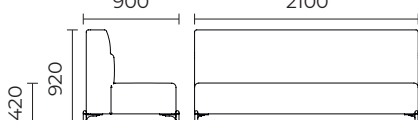
Design by Nørgaard Design

Product	Description (Item nr)	Weight (Kg)	Dimensions (mm)	Band	Same colour (SEK)	Different seat colour (SEK)
	<b>PEA3</b> FourPeople Modules low back for back panel, 3 Seater			1	26.957	5.392
				2	27.976	5.595
				3	29.057	5.811
				4	31.399	6.280
				5	32.479	6.496
				6	33.280	6.657
				7	36.047	7.210
	<b>PEB3</b> FourPeople Modules high back for back panel, 3 Seater			1	31.242	5.392
				2	32.491	5.595
				3	33.827	5.811
				4	36.703	6.280
				5	38.025	6.496
				6	39.009	6.657
				7	42.420	7.210

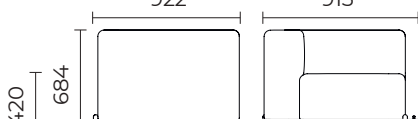
SURCHARGE	Open panel		Panel / Straps		Panel / Fabric			Acoustic		Armrest	
	Back	1 x Side	Back	1 x Side	Band	Back	1 x Side	Back	1 x Side	1 x	
Panel height	H: 1020	4.322	4.225	8.121	5.390	1	6.725	4.929	9.310	6.131	1.784
						2	7.635	5.354	10.220	6.555	2.085
						3	8.594	5.803	11.179	7.005	2.413
						4	10.694	6.785	13.279	7.987	3.105
						5	11.665	7.235	14.250	8.436	3.424
						6	12.381	7.562	14.966	8.764	3.659
						7	14.869	8.716	17.454	9.917	4.488
H: 1370	7.539	6.580	10.524	7.781	1	9.055	7.283	13.618	8.618	1.784	
					2	9.966	7.709	14.529	9.044	2.085	
					3	10.924	8.157	15.487	9.492	2.413	
					4	13.024	9.140	17.587	10.476	3.105	
					5	13.995	9.590	18.558	10.925	3.424	
					6	14.711	9.917	19.274	11.253	3.659	
					7	17.199	11.070	21.762	12.406	4.488	
H: 1720	4.147	6.676	10.646	7.805	1	9.796	7.624	14.409	9.954	1.784	
					2	11.155	8.266	15.768	10.596	2.085	
					3	12.587	8.933	17.199	11.264	2.413	
					4	15.706	10.403	20.318	12.733	3.105	
					5	17.151	11.070	21.764	13.400	3.424	
					6	18.218	11.580	22.831	13.910	3.659	
					7	21.921	13.303	26.533	15.633	4.488	

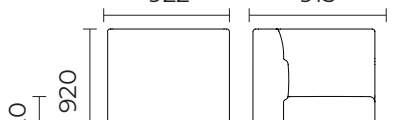
Product	Description (Item nr)	Weight (Kg)	Dimensions (mm)	Band	Same colour (SEK)	Different seat colour (SEK)
	<b>PEAC</b> FourPeople Modules low back for back panel, Corner 90°			1	18.303	3.661
				2	19.032	3.807
				3	19.796	3.959
				4	21.447	4.290
				5	22.211	4.443
				6	22.783	4.557
				7	24.748	4.950
	<b>PEBC</b> FourPeople Modules high back for back panel, Corner 90°			1	22.394	3.661
				2	23.365	3.807
				3	24.396	3.959
				4	26.642	4.290
				5	27.673	4.443
				6	28.450	4.557
				7	31.109	4.950

# FourPeople Modules for panels

[Content](#) ↗

Design by Nørgaard Design

SURCHARGE	Open panel		Panel / Straps		Panel / Fabric			Acoustic		Armrest
	Panel height	Back	1 x Side	Back	1 x Side	Band	Back	1 x Side	Back	1 x Side
H: 1020	4.224	4.224	5.390	5.390	1	4.929	4.929	6.131	6.131	1.784
					2	5.354	5.354	6.555	6.555	2.085
					3	5.803	5.803	7.005	7.005	2.413
					4	6.785	6.785	7.987	7.987	3.105
					5	7.235	7.235	8.436	8.436	3.424
					6	7.562	7.562	8.764	8.764	3.659
					7	8.716	8.716	9.917	9.917	4.488
H: 1370	6.580	6.580	7.781	7.781	1	7.283	7.283	8.618	8.618	1.784
					2	7.709	7.709	9.044	9.044	2.085
					3	8.157	8.157	9.492	9.492	2.413
					4	9.140	9.140	10.476	10.476	3.105
					5	9.590	9.590	10.925	10.925	3.424
					6	9.917	9.917	11.253	11.253	3.659
					7	11.070	11.070	12.406	12.406	4.488
H: 1720	6.676	6.676	7.805	7.805	1	7.624	7.624	9.954	9.954	1.784
					2	8.266	8.266	10.596	10.596	2.085
					3	8.933	8.933	11.264	11.264	2.413
					4	10.403	10.403	12.733	12.733	3.105
					5	11.070	11.070	13.400	13.400	3.424
					6	11.580	11.580	13.910	13.910	3.659
					7	13.303	13.303	15.633	15.633	4.488

ACCESSORIES	Description	Weight (Kg)	Dimensions (mm)	Band	Price (SEK)
	<b>FOURPEOPLE TRAY ACC1002</b>	1,8 kg			478
	<b>FOURPEOPLE HOOK ACC1001</b>	0,1 kg			126

# FourPeople Stand alone panels

Design by Nørgaard Design

[Content](#) ↗









## FEATURES

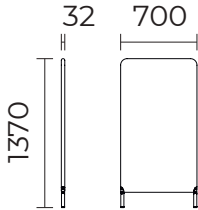

- Panel Options: Open panel, Panel with straps, Fabric Panel, Fabric Panel with Acoustic Filling
- Offer acoustic and visual privacy
- Leg and frame in black (RAL7021)
- Diameter of foot 30 cm
- Upholstery available in various fabrics. For recommendations, please contact your sales representative

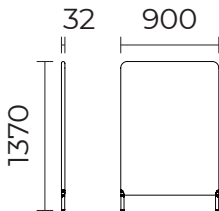

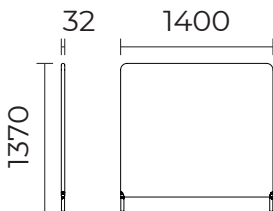

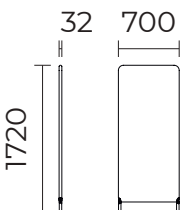





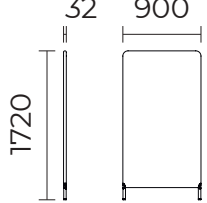

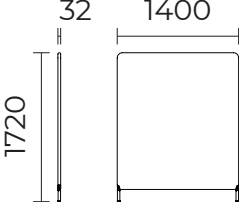

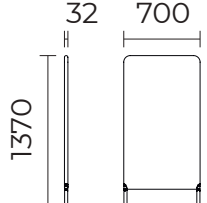
For product information visit [oceefour.com](https://oceefour.com) ↗

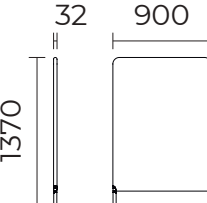
For full band and colour details [go to page 238](#) ↗

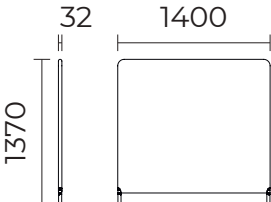
Product	Description (Item nr)	Weight (Kg)	Dimensions (mm)	Band	Standard (SEK)
	<b>PEG1131</b> FourPeople Panel, Stand alone, W: 700, H: 1370, Frame	-		-	9.250
	<b>PEG1231</b> FourPeople Panel, Stand alone, W: 900, H: 1370, Frame	-		-	9.455
	<b>PEG1331</b> FourPeople Panel, Stand alone, W: 1400, H: 1370, Frame	-		-	9.966
	<b>PEG1141</b> FourPeople Panel, Stand alone, W: 700, H: 1720, Frame	-		-	9.492

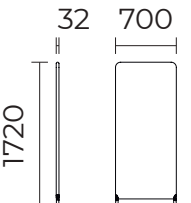
# FourPeople Stand alone panels

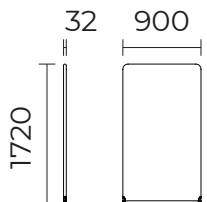
Design by Nørgaard Design

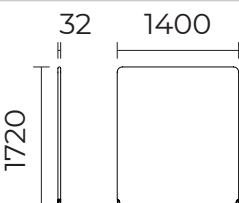









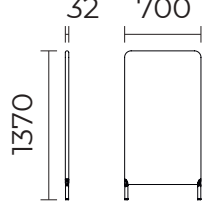

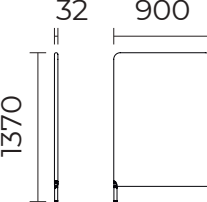

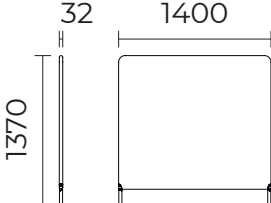
Product	Description (Item nr)	Weight (Kg)	Dimensions (mm)	Band	Standard (SEK)
	<b>PEG1241</b> FourPeople Panel, Stand alone, W: 900, H: 1720, Frame	-		-	9.553
	<b>PEG1341</b> FourPeople Panel, Stand alone, W: 1400, H: 1720, Frame	-		-	10.232
	<b>PEG1132</b> FourPeople Panel, Stand alone, W: 700, H: 1370, Straps	-		-	10.147
	<b>PEG1232</b> FourPeople Panel, Stand alone, W: 900, H: 1370, Straps	-		-	10.646
	<b>PEG1332</b> FourPeople Panel, Stand alone, W: 1400, H: 1370, Straps	-		-	11.907
	<b>PEG1142</b> FourPeople Panel, Stand alone, W: 700, H: 1720, Straps	-		-	10.414
	<b>PEG1242</b> FourPeople Panel, Stand alone, W: 900, H: 1720, Straps	-		-	10.791
	<b>PEG1342</b> FourPeople Panel, Stand alone, W: 1400, H: 1720, Straps	-		-	12.259

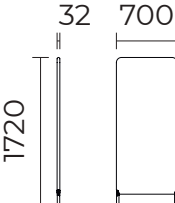

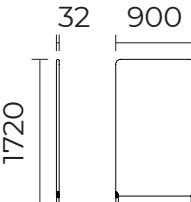
# FourPeople Stand alone panels

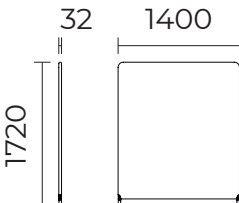
[Content ↗](#)

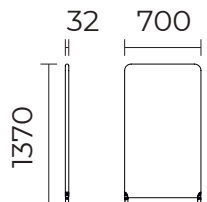

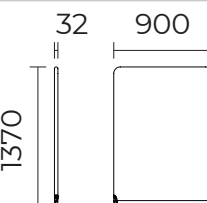



Design by Nørgaard Design

Product	Description (Item nr)	Weight (Kg)	Dimensions (mm)	Band	Standard (SEK)
	<b>PEG1133</b> FourPeople Panel, Stand alone, W: 700, H: 1370, Fabric	-		1 2 3 4 5 6 7	9.772 10.099 10.427 11.168 11.507 11.750 12.624
	<b>PEG1233</b> FourPeople Panel, Stand alone, W: 900, H: 1370, Fabric	-		1 2 3 4 5 6 7	10.124 10.524 10.948 11.883 12.309 12.624 13.716
	<b>PEG1333</b> FourPeople Panel, Stand alone, W: 1400, H: 1370, Fabric	-		1 2 3 4 5 6 7	10.985 11.605 12.259 13.668 14.322 14.809 16.483
	<b>PEG1143</b> FourPeople Panel, Stand alone, W: 700, H: 1720, Fabric	-		1 2 3 4 5 6 7	10.269 10.731 11.228 12.296 12.794 13.158 14.432
	<b>PEG1243</b> FourPeople Panel, Stand alone, W: 900, H: 1720, Fabric	-		1 2 3 4 5 6 7	10.536 11.131 11.762 13.133 13.765 14.225 15.840
	<b>PEG1343</b> FourPeople Panel, Stand alone, W: 1400, H: 1720, Fabric	-		1 2 3 4 5 6 7	11.750 12.659 13.631 15.731 16.702 17.418 19.894
	<b>PEG1134</b> FourPeople Panel, Stand alone, W: 700, H: 1370, Fabric with acoustic	-		1 2 3 4 5 6 7	10.985 11.313 11.640 12.381 12.721 12.964 13.837
	<b>PEG1234</b> FourPeople Panel, Stand alone, W: 900, H: 1370, Fabric with acoustic	-		1 2 3 4 5 6 7	11.459 11.859 12.284 13.218 13.644 13.959 15.051

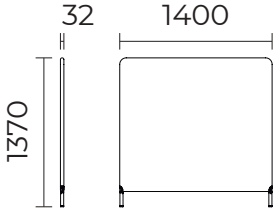
# FourPeople Stand alone panels

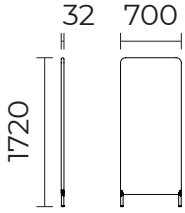
[Content ↗](#)

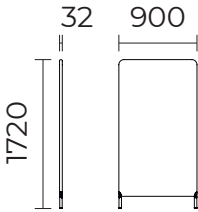
Design by Nørgaard Design

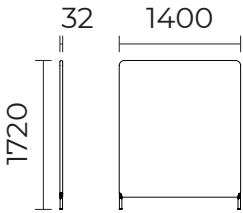
Product	Description (Item nr)	Weight (Kg)	Dimensions (mm)	Band	Standard (SEK)
	<b>PEG1334</b> FourPeople Panel, Stand alone, W: 1400, H: 1370, Fabric with acoustic	-		1 2 3 4 5 6 7	13.340 13.959 14.614 16.022 16.677 17.164 18.837
	<b>PEG1144</b> FourPeople Panel, Stand alone, W: 700, H: 1720, Fabric with acoustic	-		1 2 3 4 5 6 7	13.474 13.936 14.433 15.502 15.999 16.364 17.637
	<b>PEG1244</b> FourPeople Panel, Stand alone, W: 900, H: 1720, Fabric with acoustic	-		1 2 3 4 5 6 7	12.866 13.461 14.092 15.464 16.095 16.555 18.170
	<b>PEG1344</b> FourPeople Panel, Stand alone, W: 1400, H: 1720, Fabric with acoustic	-		1 2 3 4 5 6 7	16.277 17.187 18.158 20.258 21.229 21.946 24.421

ACCESSORIES	Description	Weight (Kg)	Dimensions (mm)	Band	Price (SEK)
	<b>FOURPEOPLE HOOK ACC1001</b>	0,1 kg			126

# FourPeople Add on panels

Design by Nørgaard Design

[Content](#) ↗



## FEATURES



- Panel Options: Open panel, Panel with straps, Fabric Panel, Fabric Panel with Acoustic Filling
- Can be combined with modules or modules with panels
- Offer acoustic and visual privacy
- Leg and frame in black (RAL7021)
- Diameter of foot 30 cm
- Upholstery available in various fabrics. For recommendations, please contact your sales representative











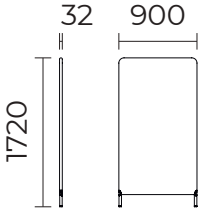

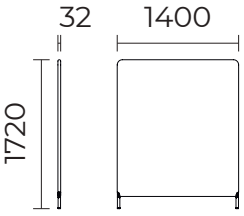

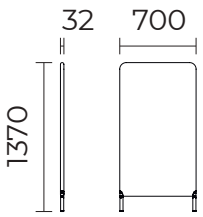
For product information visit [oceefour.com](https://oceefour.com) ↗

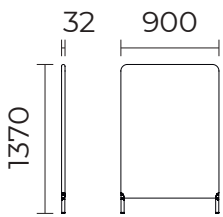
For full band and colour details [go to page 238](#) ↗

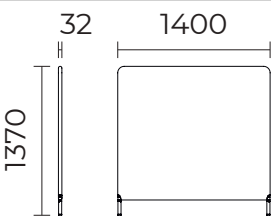
Product	Description (Item nr)	Weight (Kg)	Dimensions (mm)	Band	Standard (SEK)
	<b>PEG2131</b> FourPeople Panel, Add on, W: 700, H: 1370, Frame	-	32 700 1370	-	8.121
	<b>PEG2231</b> FourPeople Panel, Add on, W: 900, H: 1370, Frame	-	32 900 1370	-	8.327
	<b>PEG2331</b> FourPeople Panel, Add on, W: 1400, H: 1370, Frame	-	32 1400 1370	-	8.837
	<b>PEG2141</b> FourPeople Panel, Add on, W: 700, H: 1720, Frame	-	32 700 1720	-	8.364

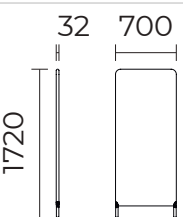
# FourPeople Add on panels

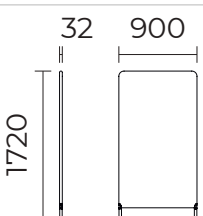

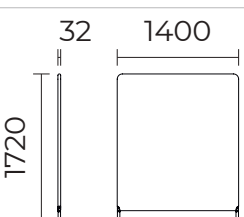







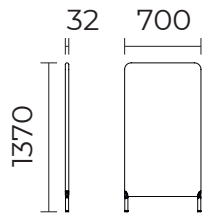

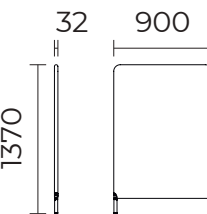

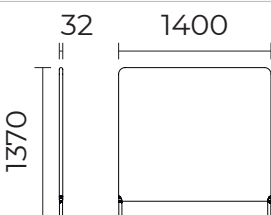
Design by Nørgaard Design

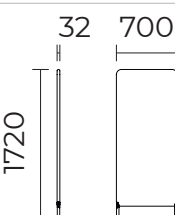
Product	Description (Item nr)	Weight (Kg)	Dimensions (mm)	Band	Standard (SEK)
	<b>PEG2241</b> FourPeople Panel, Add on, W: 900, H: 1720, Frame	-		-	8.424
	<b>PEG2341</b> FourPeople Panel, Add on, W: 1400, H: 1720, Frame	-		-	9.116
	<b>PEG2132</b> FourPeople Panel, Add on, W: 700, H: 1370, Straps	-		-	9.068
	<b>PEG2232</b> FourPeople Panel, Add on, W: 900, H: 1370, Straps	-		-	9.529
	<b>PEG2332</b> FourPeople Panel, Add on, W: 1400, H: 1370, Straps	-		-	10.791
	<b>PEG2142</b> FourPeople Panel, Add on, W: 700, H: 1720, Straps	-		-	9.298
	<b>PEG2242</b> FourPeople Panel, Add on, W: 900, H: 1720, Straps	-		-	9.674
	<b>PEG2342</b> FourPeople Panel, Add on, W: 1400, H: 1720, Straps	-		-	11.131

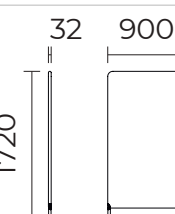
# FourPeople Add on panels

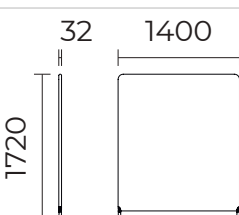
[Content ↗](#)

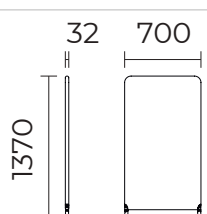

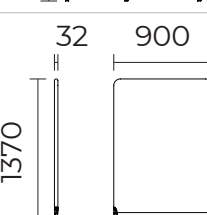



Design by Nørgaard Design

Product	Description (Item nr)	Weight (Kg)	Dimensions (mm)	Band	Standard (SEK)
	<b>PEG2133</b> FourPeople Panel, Add on, W: 700, H: 1370, Fabric	-		1 2 3 4 5 6 7	8.654 8.969 9.309 10.039 10.379 10.633 11.495
	<b>PEG2233</b> FourPeople Panel, Add on, W: 900, H: 1370, Fabric	-		1 2 3 4 5 6 7	9.007 9.407 9.832 10.754 11.191 11.507 12.599
	<b>PEG2333</b> FourPeople Panel, Add on, W: 1400, H: 1370, Fabric	-		1 2 3 4 5 6 7	9.869 10.476 11.131 12.551 13.194 13.680 15.354
	<b>PEG2143</b> FourPeople Panel, Add on, W: 700, H: 1720, Fabric	-		1 2 3 4 5 6 7	9.140 9.614 10.099 11.180 11.677 12.042 13.316
	<b>PEG2243</b> FourPeople Panel, Add on, W: 900, H: 1720, Fabric	-		1 2 3 4 5 6 7	9.420 10.014 10.646 12.005 12.636 13.109 14.724
	<b>PEG2343</b> FourPeople Panel, Add on, W: 1400, H: 1720, Fabric	-		1 2 3 4 5 6 7	10.633 11.543 12.514 14.614 15.573 16.290 18.777
	<b>PEG2134</b> FourPeople Panel, Add on, W: 700, H: 1370, Fabric with acoustic	-		1 2 3 4 5 6 7	9.868 10.183 10.522 11.253 11.592 11.847 12.709
	<b>PEG2234</b> FourPeople Panel, Add on, W: 900, H: 1370, Fabric with acoustic	-		1 2 3 4 5 6 7	10.343 10.743 11.168 12.090 12.527 12.843 13.935

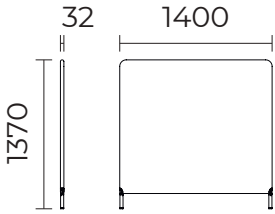
# FourPeople Add on panels

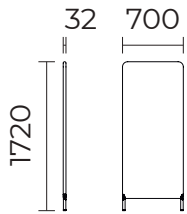
[Content ↗](#)

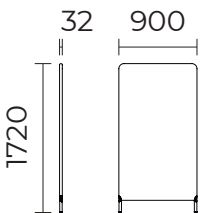
Design by Nørgaard Design

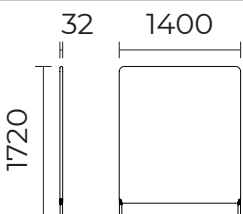
Product	Description (Item nr)	Weight (Kg)	Dimensions (mm)	Band	Standard (SEK)
	<b>PEG2334</b> FourPeople Panel, Add on, W: 1400, H: 1370, Fabric with acoustic	-		1 2 3 4 5 6 7	12.224 12.831 13.485 14.906 15.548 16.035 17.709
	<b>PEG2144</b> FourPeople Panel, Add on, W: 700, H: 1720, Fabric with acoustic	-		1 2 3 4 5 6 7	10.743 11.217 11.702 12.783 13.280 13.644 14.918
	<b>PEG2244</b> FourPeople Panel, Add on, W: 900, H: 1720, Fabric with acoustic	-		1 2 3 4 5 6 7	11.750 12.344 12.976 14.335 14.966 15.439 17.054
	<b>PEG2344</b> FourPeople Panel, Add on, W: 1400, H: 1720, Fabric with acoustic	-		1 2 3 4 5 6 7	15.161 16.070 17.042 19.142 20.100 20.817 23.305

ACCESSORIES	Description	Weight (Kg)	Dimensions (mm)	Band	Price (SEK)
	<b>FOURPEOPLE HOOK ACC1001</b>	0,1 kg			126

# FourPeople Work Booth

Design by Nørgaard Design

[Content ↗](#)



## FEATURES







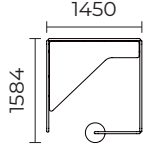

- Work Booth in various configurations.
- Closed concentrated work area with acoustic and visual privacy.
- Two heights 1370 cm or 1720 cm.
- Including table top in two heights: Standing 105 cm or sitting 74 cm.
- Black Nano laminate 21 mm table top with impact resistant ABS edges. Leg in black (RAL7021).
- Electrical units are optional and will be positioned in the centre of tables as standard.
- Upholstery available in various fabrics. For recommendations, please contact your sales representative

For product information visit [oceefour.com](https://oceefour.com) ↗

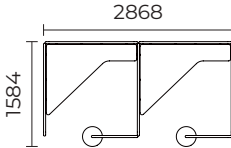
For electrical accessories [go to page 228](#) ↗

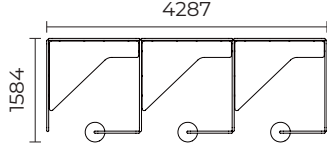
For full band and colour details [go to page 238](#) ↗

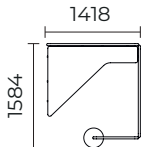









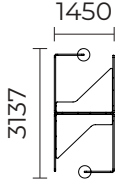

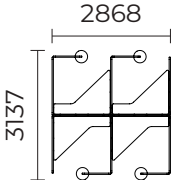

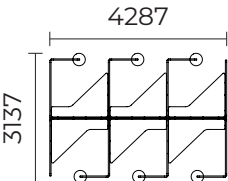
Product	Description (Item nr)	Weight (Kg)	Dimensions (mm)	Band	Price (SEK)
	<b>PEJ13</b> FourPeople Single Work Booth, 1 Booth, H: 1370	119.1		<ul style="list-style-type: none"> <li>1 49.021</li> <li>2 51.206</li> <li>3 53.511</li> <li>4 58.536</li> <li>5 60.855</li> <li>6 62.579</li> <li>7 68.525</li> </ul>	
	<b>PEJ23</b> FourPeople Single Work Booth, 2 Booth, H: 1370	205.4		<ul style="list-style-type: none"> <li>1 87.898</li> <li>2 91.647</li> <li>3 95.628</li> <li>4 104.270</li> <li>5 108.251</li> <li>6 111.200</li> <li>7 121.432</li> </ul>	
	<b>PEJ33</b> FourPeople Single Work Booth, 3 Booth, H: 1370	291.7		<ul style="list-style-type: none"> <li>1 126.906</li> <li>2 132.221</li> <li>3 137.865</li> <li>4 150.111</li> <li>5 155.755</li> <li>6 159.943</li> <li>7 174.446</li> </ul>	
	<b>PEJX3</b> FourPeople Single Work Booth, Extension, H: 1370	86.3		<ul style="list-style-type: none"> <li>1 39.761</li> <li>2 41.328</li> <li>3 42.991</li> <li>4 46.607</li> <li>5 48.270</li> <li>6 49.507</li> <li>7 53.780</li> </ul>	

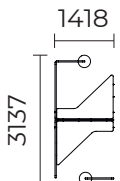

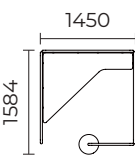
# FourPeople Work Booth

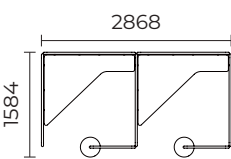
[Content ↗](#)

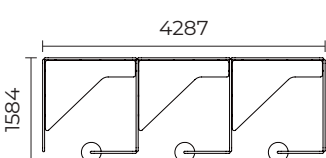

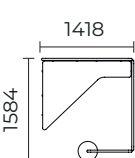



Design by Nørgaard Design

Product	Description (Item nr)	Weight (Kg)	Dimensions (mm)	Band	Price (SEK)
	<b>PEK13</b> FourPeople Double Work Booth, 1 Booth, H: 1370	-		<ul style="list-style-type: none"> <li>1 88.128</li> <li>2 91.879</li> <li>3 95.859</li> <li>4 104.488</li> <li>5 108.469</li> <li>6 111.431</li> <li>7 121.662</li> </ul>	
	<b>PEK23</b> FourPeople Double Work Booth, 2 Booth, H: 1370	205.4		<ul style="list-style-type: none"> <li>1 156.642</li> <li>2 162.916</li> <li>3 169.568</li> <li>4 184.010</li> <li>5 190.661</li> <li>6 195.600</li> <li>7 212.714</li> </ul>	
	<b>PEK33</b> FourPeople Double Work Booth, 3 Booth, H: 1370	-		<ul style="list-style-type: none"> <li>1 234.416</li> <li>2 243.202</li> <li>3 252.536</li> <li>4 272.792</li> <li>5 282.113</li> <li>6 289.043</li> <li>7 313.027</li> </ul>	
	<b>PEKX3</b> FourPeople Double Work Booth, Extension, H: 1370	139.7		<ul style="list-style-type: none"> <li>1 69.837</li> <li>2 72.362</li> <li>3 75.032</li> <li>4 80.846</li> <li>5 83.516</li> <li>6 85.506</li> <li>7 92.388</li> </ul>	
	<b>PEJ14</b> FourPeople Single Work Booth, 1 Booth, H: 1720	-		<ul style="list-style-type: none"> <li>1 51.692</li> <li>2 52.142</li> <li>3 54.459</li> <li>4 59.484</li> <li>5 61.803</li> <li>6 63.513</li> <li>7 69.473</li> </ul>	
	<b>PEJ24</b> FourPeople Single Work Booth, 2 Booth, H: 1720	-		<ul style="list-style-type: none"> <li>1 92.703</li> <li>2 98.237</li> <li>3 104.100</li> <li>4 116.844</li> <li>5 122.706</li> <li>6 127.064</li> <li>7 142.148</li> </ul>	
	<b>PEJ34</b> FourPeople Single Work Booth, 3 Booth, H: 1720	-		<ul style="list-style-type: none"> <li>1 133.727</li> <li>2 141.568</li> <li>3 149.881</li> <li>4 167.940</li> <li>5 176.254</li> <li>6 182.432</li> <li>7 203.817</li> </ul>	
	<b>PEJX4</b> FourPeople Single Work Booth, Extension, H: 1720	-		<ul style="list-style-type: none"> <li>1 41.777</li> <li>2 44.095</li> <li>3 46.535</li> <li>4 51.862</li> <li>5 54.314</li> <li>6 56.135</li> <li>7 62.433</li> </ul>	

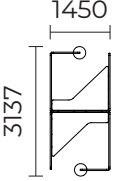
# FourPeople Work Booth

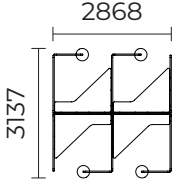
[Content ↗](#)

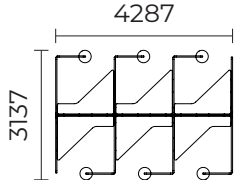
Design by Nørgaard Design

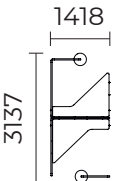
Product	Description (Item nr)	Weight (Kg)	Dimensions (mm)	Band	Price (SEK)
	<b>PEK14</b> FourPeople Double Work Booth, 1 Booth, H: 1720	-		<ul style="list-style-type: none"> <li>1 92.935</li> <li>2 98.469</li> <li>3 104.331</li> <li>4 117.062</li> <li>5 122.936</li> <li>6 127.294</li> <li>7 142.380</li> </ul>	
	<b>PEK24</b> FourPeople Double Work Booth, 2 Booth, H: 1720	-		<ul style="list-style-type: none"> <li>1 164.713</li> <li>2 173.961</li> <li>3 183.755</li> <li>4 205.031</li> <li>5 214.837</li> <li>6 222.107</li> <li>7 247.317</li> </ul>	
	<b>PEK34</b> FourPeople Double Work Booth, 3 Booth, H: 1720	-		<ul style="list-style-type: none"> <li>1 236.831</li> <li>2 249.780</li> <li>3 263.520</li> <li>4 293.340</li> <li>5 307.066</li> <li>6 317.274</li> <li>7 352.580</li> </ul>	
	<b>PEKX4</b> FourPeople Double Work Booth, Extension, H: 1720	-		<ul style="list-style-type: none"> <li>1 73.114</li> <li>2 76.816</li> <li>3 80.748</li> <li>4 89.294</li> <li>5 93.225</li> <li>6 96.150</li> <li>7 106.261</li> </ul>	

ACCESSORIES	Description	Weight (Kg)	Dimensions (mm)	Band	Price (SEK)
	<b>FOURPEOPLE HOOK ACC1001</b>	0,1 kg			126

# FourPeople Study Booth

Design by Nørgaard Design

[Content ↗](#)



## FEATURES



- Study Booth in various configurations.
- Private touch down area with acoustic and visual privacy.
- Two heights 1370 or 1720 cm.
- Including table top in two heights: Standing 105 cm or sitting 74 cm.
- Black Nano laminate 21 mm table top with impact resistant ABS edges. Leg in standard black (RAL7021).
- Electrical units are optional and will be positioned in the centre of tables as standard.
- Upholstery available in various fabrics. For recommendations, please contact your sales representative.

For product information visit [oceefour.com](https://oceefour.com) ↗

For electrical accessories [go to page 228](#) ↗







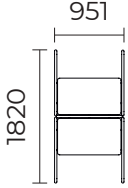

For full band and colour details [go to page 238](#) ↗

Product	Description (Item nr)	Weight (Kg)	Dimensions (mm)	Band	Price (SEK)
	<b>PEH13</b> FourPeople Single Study Booth, 1 Booth, H: 1370	71.6		<ul style="list-style-type: none"> <li>1 30.270</li> <li>2 31.546</li> <li>3 32.892</li> <li>4 35.817</li> <li>5 37.165</li> <li>6 38.172</li> <li>7 41.631</li> </ul>	
	<b>PEH23</b> FourPeople Single Study Booth, 2 Booth, H: 1370	123.8		<ul style="list-style-type: none"> <li>1 47.227</li> <li>2 53.198</li> <li>3 55.443</li> <li>4 60.322</li> <li>5 62.580</li> <li>6 64.242</li> <li>7 70.020</li> </ul>	
	<b>PEH33</b> FourPeople Single Study Booth, 3 Booth, H: 1370	174.5		<ul style="list-style-type: none"> <li>1 70.906</li> <li>2 73.866</li> <li>3 77.022</li> <li>4 83.855</li> <li>5 86.999</li> <li>6 89.329</li> <li>7 97.425</li> </ul>	
	<b>PEHX3</b> FourPeople Single Study Booth, Extension, H: 1370	50.7		<ul style="list-style-type: none"> <li>1 21.581</li> <li>2 22.431</li> <li>3 23.328</li> <li>4 25.270</li> <li>5 26.181</li> <li>6 26.848</li> <li>7 29.154</li> </ul>	

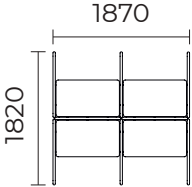
# FourPeople Study Booth

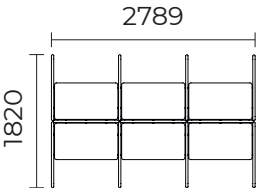
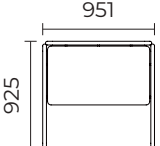
[Content ↗](#)

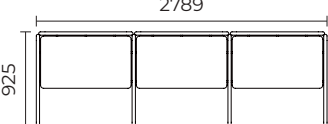

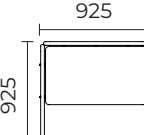



Design by Nørgaard Design

Product	Description (Item nr)	Weight (Kg)	Dimensions (mm)	Band	Price (SEK)
	<b>PEI13</b> FourPeople Double Study Booth, 1 Booth, H: 1370	121.9		1 2 3 4 5 6 7	49.969 52.094 54.339 59.217 61.464 63.137 68.916
	<b>PEI23</b> FourPeople Double Study Booth, 2 Booth, H: 1370	202.8		1 2 3 4 5 6 7	81.792 83.917 86.162 91.040 93.285 94.961 100.737
	<b>PEI33</b> FourPeople Double Study Booth, 3 Booth, H: 1370	-		1 2 3 4 5 6 7	117.839 122.499 127.451 138.181 143.132 146.798 159.517
	<b>PEIX3</b> FourPeople Double Study Booth, Extension, H: 1370	79		1 2 3 4 5 6 7	34.591 35.866 37.213 40.139 41.485 42.492 45.964
	<b>PEH14</b> FourPeople Single Study Booth, 1 Booth, H: 1720	-		1 2 3 4 5 6 7	31.618 33.536 35.550 39.944 41.970 43.476 48.670
	<b>PEH24</b> FourPeople Single Study Booth, 2 Booth, H: 1720	-		1 2 3 4 5 6 7	54.751 58.780 63.053 72.325 76.598 79.765 90.750
	<b>PEH34</b> FourPeople Single Study Booth, 3 Booth, H: 1720	-		1 2 3 4 5 6 7	76.136 81.647 87.484 100.180 106.018 110.362 125.388
	<b>PEHX4</b> FourPeople Single Study Booth, Extension, H: 1720	-		1 2 3 4 5 6 7	23.899 26.010 28.257 33.147 35.392 37.055 42.844

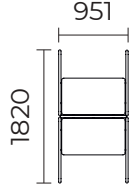
# FourPeople Study Booth

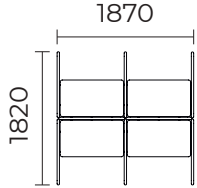
[Content ↗](#)

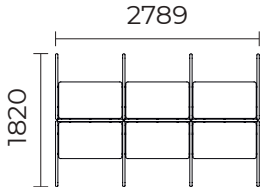
Design by Nørgaard Design

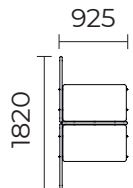
Product	Description (Item nr)	Weight (Kg)	Dimensions (mm)	Band	Price (SEK)
	<b>PEI14</b> FourPeople Double Study Booth, 1 Booth, H: 1720	-		<ul style="list-style-type: none"> <li>1</li> <li>2</li> <li>3</li> <li>4</li> <li>5</li> <li>6</li> <li>7</li> </ul>	<ul style="list-style-type: none"> <li>52.227</li> <li>55.406</li> <li>58.780</li> <li>66.099</li> <li>69.473</li> <li>71.973</li> <li>80.651</li> </ul>
	<b>PEI24</b> FourPeople Double Study Booth, 2 Booth, H: 1720	-		<ul style="list-style-type: none"> <li>1</li> <li>2</li> <li>3</li> <li>4</li> <li>5</li> <li>6</li> <li>7</li> </ul>	<ul style="list-style-type: none"> <li>86.744</li> <li>91.829</li> <li>97.218</li> <li>108.931</li> <li>114.332</li> <li>118.336</li> <li>132.209</li> </ul>
	<b>PEI34</b> FourPeople Double Study Booth, 3 Booth, H: 1720	-		<ul style="list-style-type: none"> <li>1</li> <li>2</li> <li>3</li> <li>4</li> <li>5</li> <li>6</li> <li>7</li> </ul>	<ul style="list-style-type: none"> <li>121.722</li> <li>128.727</li> <li>136.142</li> <li>152.247</li> <li>159.664</li> <li>165.173</li> <li>184.240</li> </ul>
	<b>PEIX4</b> FourPeople Double Study Booth, Extension, H: 1720	-		<ul style="list-style-type: none"> <li>1</li> <li>2</li> <li>3</li> <li>4</li> <li>5</li> <li>6</li> <li>7</li> </ul>	<ul style="list-style-type: none"> <li>35.951</li> <li>37.857</li> <li>39.883</li> <li>44.277</li> <li>46.292</li> <li>47.796</li> <li>53.003</li> </ul>

ACCESSORIES	Description	Weight (Kg)	Dimensions (mm)	Band	Price (SEK)
	<b>FOURPEOPLE HOOK ACC1001</b>	0,1 kg			126

# FourPeople Work Hut

Design by Nørgaard Design

[Content ↗](#)



## FEATURES



- Private touch down area with acoustic and visual privacy.
- Including table top in two heights: Standing 105 cm or sitting 74 cm, right or left side.
- Black Nano laminate 21 mm table top with impact resistant ABS edges. Leg in black (RAL7021).
- Electrical units are optional and will be positioned in the centre of tables as standard.
- Upholstery available in various fabrics. For recommendations, please contact your sales representative.

For product information visit [oceefour.com](https://oceefour.com) ↗

For electrical accessories [go to page 228](#) ↗

For full band and colour details [go to page 238](#) ↗

Product	Description (Item nr)	Weight (Kg)	Dimensions (mm)	Band	Price (SEK)														
	<b>PEM3L</b> FourPeople Work Hut, Fabric, Left	-		<table border="1"> <tr><td>1</td><td>42.432</td></tr> <tr><td>2</td><td>45.891</td></tr> <tr><td>3</td><td>49.555</td></tr> <tr><td>4</td><td>57.506</td></tr> <tr><td>5</td><td>61.170</td></tr> <tr><td>6</td><td>63.890</td></tr> <tr><td>7</td><td>73.307</td></tr> </table>	1	42.432	2	45.891	3	49.555	4	57.506	5	61.170	6	63.890	7	73.307	
1	42.432																		
2	45.891																		
3	49.555																		
4	57.506																		
5	61.170																		
6	63.890																		
7	73.307																		
	<b>PEM3R</b> FourPeople Work Hut, Fabric, Right	-		<table border="1"> <tr><td>1</td><td>42.432</td></tr> <tr><td>2</td><td>45.891</td></tr> <tr><td>3</td><td>49.555</td></tr> <tr><td>4</td><td>57.506</td></tr> <tr><td>5</td><td>61.170</td></tr> <tr><td>6</td><td>63.890</td></tr> <tr><td>7</td><td>73.307</td></tr> </table>	1	42.432	2	45.891	3	49.555	4	57.506	5	61.170	6	63.890	7	73.307	
1	42.432																		
2	45.891																		
3	49.555																		
4	57.506																		
5	61.170																		
6	63.890																		
7	73.307																		

ACCESSORIES	Description	Weight (Kg)	Dimensions (mm)	Band	Price (SEK)
	<b>FOURPEOPLE HOOK</b> ACCT001	0,1 kg			126

# FourPeople Sofa Hut

Design by Nørgaard Design

[Content ↗](#)



## FEATURES



- Provide a relaxed and sociable space with acoustic and visual privacy.
- Comes in low or high back with straps or fabric.
- Two tone fabric options available.
- Electrical units are optional and will be positioned on the left or right side of sofas as standard.
- Leg in black (RAL7021).
- Upholstery available in various fabrics. For recommendations, please contact your sales representative.

For product information visit [oceefour.com](https://oceefour.com) ↗

For electrical accessories [go to page 228](#) ↗

For full band and colour details [go to page 238](#) ↗

Product	Description (Item nr)	Weight (Kg)	Dimensions (mm)	Band	Price (SEK)
	<b>PEL2H</b> FourPeople Sofa Hut, Straps, High back	70		<ul style="list-style-type: none"> <li>1 49.969</li> <li>2 50.879</li> <li>3 51.850</li> <li>4 53.950</li> <li>5 54.921</li> <li>6 55.636</li> <li>7 58.125</li> </ul>	
	<b>PEL2L</b> FourPeople Sofa Hut, Straps, Low back	41.6		<ul style="list-style-type: none"> <li>1 47.190</li> <li>2 47.869</li> <li>3 48.585</li> <li>4 50.151</li> <li>5 50.866</li> <li>6 51.400</li> <li>7 53.246</li> </ul>	
	<b>PEL3H</b> FourPeople Sofa Hut, Fabric, High back	-		<ul style="list-style-type: none"> <li>1 48.257</li> <li>2 52.420</li> <li>3 56.827</li> <li>4 66.390</li> <li>5 70.795</li> <li>6 74.061</li> <li>7 85.396</li> </ul>	
	<b>PEL3L</b> FourPeople Sofa Hut, Fabric, Low back	-		<ul style="list-style-type: none"> <li>1 45.477</li> <li>2 49.398</li> <li>3 53.548</li> <li>4 62.579</li> <li>5 66.742</li> <li>6 69.825</li> <li>7 80.517</li> </ul>	







FourLikes®



FourLikes® Meet



FourLikes® Scooter |  
Wheels



FourLikes® Scooter



FourLikes® Wall bench









## FEATURES



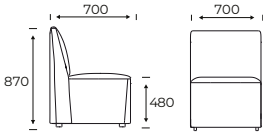

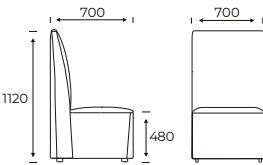

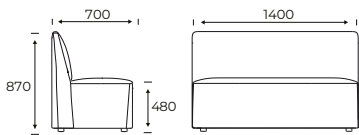

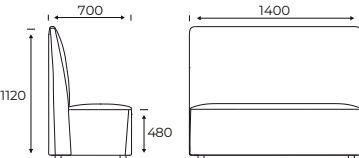

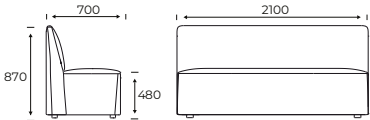

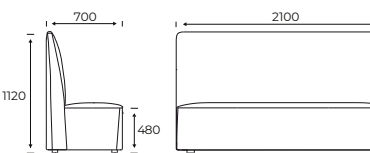

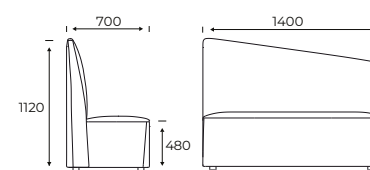
- Modular and flexible system. Modules in different lengths.
- Low and high back modules. Uni- or Multicoloured.
- Active seat height 48 cm (fits table height 74 cm).
- Frame delivered as standard in black.
- Electrical units are optional and will be positioned on the left or right side of sofas as standard.

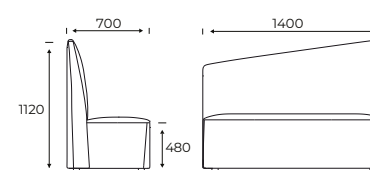

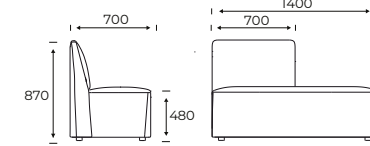

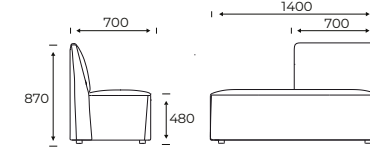

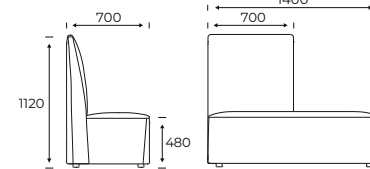

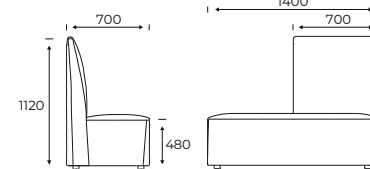

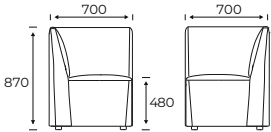

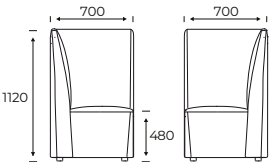

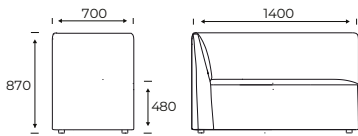
For product information visit [oceefour.com](http://oceefour.com) ↗

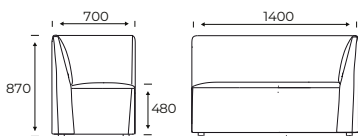

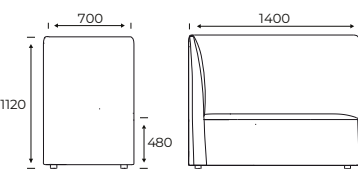

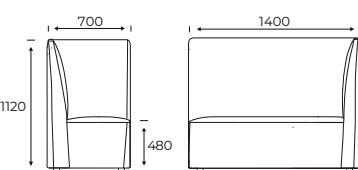

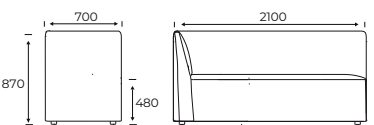

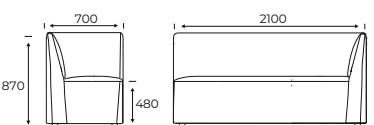

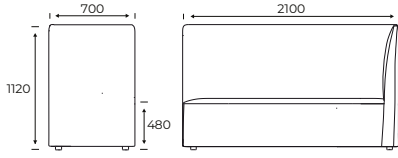
For electrical accessories [go to page 228](#) ↗

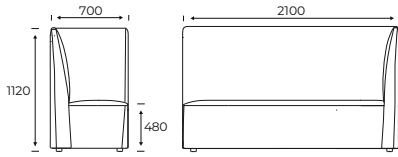
For full band and colour details [go to page 238](#) ↗

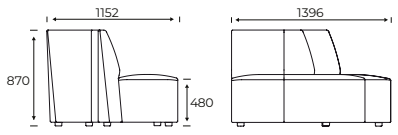
Product	Description (Item nr)	Weight (Kg)	Dimensions (mm)	Band	Same colour (SEK)	Different seat colour (SEK)
	<b>700000</b> FourLikes®, Low back, 700	20,5 Kg		1 2 3 4 5	9.859 11.146 12.437 13.724 15.014	2.152 2.656 3.379 3.964 4.610 6.770
	<b>700010</b> FourLikes®, High back, 700	21,5 Kg		1 2 3 4 5	11.079 12.653 14.228 15.804 17.381	2.152 2.656 3.379 3.964 4.610 6.770
	<b>700001</b> FourLikes®, Low back, 1400	41,3 Kg		1 2 3 4 5	13.144 14.864 16.581 18.298 20.018	2.982 3.681 4.685 5.494 6.393 9.388
	<b>700011</b> FourLikes®, High back, 1400	42,5 Kg		1 2 3 4 5	14.772 16.873 18.973 21.072 23.173	2.982 3.681 4.685 5.494 6.393 9.388

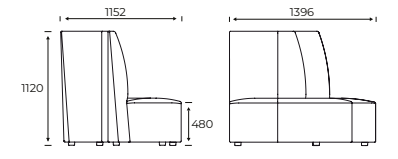
Product	Description (Item nr)	Weight (Kg)	Dimensions (mm)	Band	Same colour (SEK)	Different seat colour (SEK)
	<b>700002</b> FourLikes®, Low back, 2100	-		1 2 3 4 5	21.031 23.781 26.531 29.282 32.031	4.589 5.665 7.210 8.452 9.840 14.445
	<b>700012</b> FourLikes®, High back, 2100	-		1 2 3 4 5	23.635 26.994 30.355 33.716 37.077	4.589 5.665 7.210 8.452 9.840 14.445
	<b>700021</b> FourLikes®, Slope, High Back Right, 1400	-		1 2 3 4 5	15.777 17.878 19.978 22.077 24.179	2.982 3.681 4.685 5.494 6.393 9.388
	<b>700031</b> FourLikes®, Slope, High Back Left, 1400	-		1 2 3 4 5	15.777 17.878 19.978 22.077 24.179	2.982 3.681 4.685 5.494 6.393 9.388
	<b>700041</b> FourLikes®, Open End Left, Low Back Right, 1400	45,5 Kg		1 2 3 4 5	14.808 16.069 17.328 18.588 19.850	2.982 3.681 4.685 5.494 6.393 9.388
	<b>700051</b> FourLikes®, Open End Right, Low Back Left, 1400	45,6 Kg		1 2 3 4 5	14.808 16.069 17.328 18.588 19.850	2.982 3.681 4.685 5.494 6.393 9.388
	<b>700061</b> FourLikes®, Open End Left, High Back Right, 1400	46,8 Kg		1 2 3 4 5	16.844 18.592 20.337 22.084 23.831	2.982 3.681 4.685 5.494 6.393 9.388
	<b>700071</b> FourLikes®, Open End Right, High Back Left, 1400	46,8 Kg		1 2 3 4 5	16.844 18.592 20.337 22.084 23.831	2.982 3.681 4.685 5.494 6.393 9.388

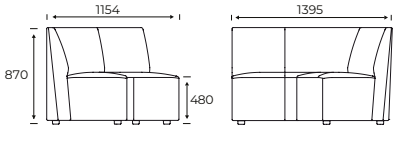
Product	Description (Item nr)	Weight (Kg)	Dimensions (mm)	Band	Same colour (SEK)	Different seat colour (SEK)
	<b>700100</b> FourLikes®, Corner, Low back, 700	20,8 Kg		1 2 3 4 5	12.979 14.343 15.706 17.072 18.436	2.152 2.656 3.379 3.964 4.610 6.770
	<b>700110</b> FourLikes®, Corner, High back, 700	27,3 Kg		1 2 3 4 5	14.868 17.073 19.281 21.487 23.694	2.152 2.656 3.379 3.964 4.610 6.770
	<b>700191</b> FourLikes®, Corner, Low Back Right, 1400	45,3 Kg		1 2 3 4 5	15.269 16.873 18.477 20.082 21.685	2.982 3.681 4.685 5.494 6.393 9.388
	<b>700181</b> FourLikes®, Corner, Low Back Left, 1400	45,3 Kg		1 2 3 4 5	15.269 16.873 18.477 20.082 21.685	2.982 3.681 4.685 5.494 6.393 9.388
	<b>7001B1</b> FourLikes®, Corner, High Back Right, 1400	50,4 Kg		1 2 3 4 5	18.191 20.893 23.592 26.292 28.995	2.982 3.681 4.685 5.494 6.393 9.388
	<b>7001A1</b> FourLikes®, Corner, High Back Left, 1400	50,4 Kg		1 2 3 4 5	18.191 20.893 23.592 26.292 28.995	2.982 3.681 4.685 5.494 6.393 9.388
	<b>700192</b> FourLikes®, Corner, Low Back Right, 2100	66,9 Kg		1 2 3 4 5	24.430 26.999 29.564 32.130 34.697	4.589 5.665 7.210 8.452 9.840 14.445
	<b>700182</b> FourLikes®, Corner, Low Back Left, 2100	66,9 Kg		1 2 3 4 5	24.430 26.999 29.564 32.130 34.697	4.589 5.665 7.210 8.452 9.840 14.445

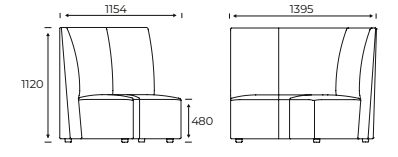
Product	Description (Item nr)	Weight (Kg)	Dimensions (mm)	Band	Same colour (SEK)	Different seat colour (SEK)
	<b>7001B2</b> FourLikes®, Corner, High Back Right, 2100	77,8 Kg		1 2 3 4 5	27.986 32.142 36.297 40.452 44.606	4.589 5.665 7.210 8.452 9.840 14.445
	<b>7001A2</b> FourLikes®, Corner, High Back Left, 2100	77,8 Kg		1 2 3 4 5	27.986 32.142 36.297 40.452 44.606	4.589 5.665 7.210 8.452 9.840 14.445
	<b>7000E7</b> FourLikes®, Convex 120 Low back, 1350			1 2 3 4 5	21.632 22.898 25.605 26.864 29.387	4.721 5.453 6.956 7.756 9.031 13.242
	<b>7000F7</b> FourLikes®, Convex 120 High back, 1350	35 kg		1 2 3 4 5	23.078 24.402 27.404 28.846 31.669	4.721 5.453 6.956 7.756 9.031 13.242
	<b>7000C1</b> FourLikes®, Concave 120 Low back, 1400	35,5 Kg		1 2 3 4 5	23.017 24.402 27.342 28.662 31.372	5.023 5.810 7.427 8.275 9.642 14.136
	<b>7000D1</b> FourLikes®, Concave 120 High back, 1400	38,5 Kg		1 2 3 4 5	25.840 27.342 30.592 32.095 35.098	5.023 5.810 7.427 8.275 9.642 14.136



## FEATURES

- Modular and flexible system. Uni- or Multicoloured.
- Acoustic and visual privacy.
- Active seat height 48 cm (fits table height 74 cm).
- Table top: 70x70cm or 120x70 cm
- Table top in black, warm grey or anthracite Nano laminate
- Electrical units are optional and will be positioned in the centre of tables as standard.

For product information visit [oceefour.com](https://oceefour.com) ↗

## TABLE TOP

Fenix laminate



## FRAME COLOURS

Standard



For electrical accessories [go to page 228](#) ↗

For full band and colour details [go to page 238](#) ↗



Product	Description (Item nr)	Weight (Kg)	Dimensions (mm)	Band	Same colour (SEK)	Different colour (SEK)
	<b>70120</b> FourLikes® Meet, 700	152 Kg		1 2 3 4 5	44.124 49.738 55.351 60.965 66.580	
	<b>70120-S</b> FourLikes® Meet, 700			1 2 3 4 5 8		4.474 5.753 7.032 8.313 9.592 13.429
	<b>70120-T</b> FourLikes® Meet, 700			1 2 3 4 5 8		6.304 7.098 7.889 8.681 9.472 11.850
	<b>70121</b> FourLikes® Meet, 1400	183 Kg		1 2 3 4 5	58.829 66.314 73.798 81.283 88.768	



# FourLikes® Meet

Design by Nørgaard Design

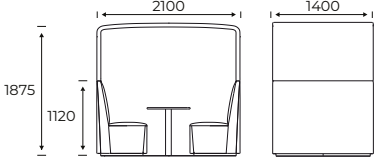
[Content ↗](#)

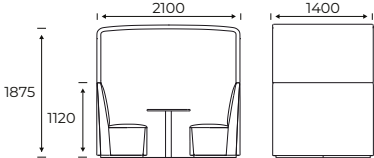
Product	Description (Item nr)	Weight (Kg)	Dimensions (mm)	Band	Same colour (SEK)	Different colour (SEK)
	<b>70121-S</b> FourLikes® Meet, 1400			1 2 3 4 5 8		5.966 7.366 9.376 10.988 12.791 18.777
	<b>70121-T</b> FourLikes® Meet, 1400			1 2 3 4 5 8		8.404 9.475 10.544 11.612 12.682 18.027

ACCESSORIES	Description	Weight (Kg)	Dimensions (mm)	Price (SEK)
	With Linking			263

# FourLikes® Scooter | Wheels

Design by Nørgaard Design

[Content ↗](#)







## FEATURES

- Scooter including wheels
- Single back or double back options
- Active seat height 48 cm (Fits table height 74 cm)

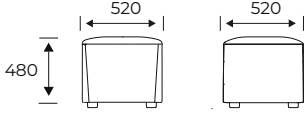

For product information visit [oceefour.com](https://oceefour.com) ↗

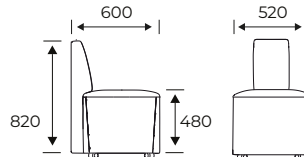
For full band and colour details [go to page 238](#) ↗

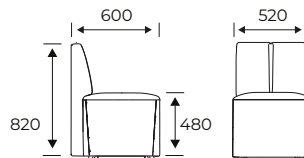
Product	Description (Item nr)	Weight (Kg)	Dimensions (mm)	Band	Same colour (SEK)												
	<b>7024030-W</b> FourLikes® Scooter, Straight, 530, Without backs, Castors	9,5 Kg		<table border="1"> <tr><td>1</td><td>6.102</td></tr> <tr><td>2</td><td>6.618</td></tr> <tr><td>3</td><td>7.137</td></tr> <tr><td>4</td><td>7.652</td></tr> <tr><td>5</td><td>8.167</td></tr> <tr><td>8</td><td>10.752</td></tr> </table>	1	6.102	2	6.618	3	7.137	4	7.652	5	8.167	8	10.752	
1	6.102																
2	6.618																
3	7.137																
4	7.652																
5	8.167																
8	10.752																
	<b>702403A-W</b> FourLikes® Scooter, Straight, 530, 1 single back, Castors	11,6 Kg		<table border="1"> <tr><td>1</td><td>8.040</td></tr> <tr><td>2</td><td>8.721</td></tr> <tr><td>3</td><td>9.405</td></tr> <tr><td>4</td><td>10.084</td></tr> <tr><td>5</td><td>10.764</td></tr> <tr><td>8</td><td>14.172</td></tr> </table>	1	8.040	2	8.721	3	9.405	4	10.084	5	10.764	8	14.172	
1	8.040																
2	8.721																
3	9.405																
4	10.084																
5	10.764																
8	14.172																
	<b>7024031-W</b> FourLikes® Scooter, Straight, 530, 1 double back, Castors	13,4 Kg		<table border="1"> <tr><td>1</td><td>9.328</td></tr> <tr><td>2</td><td>10.035</td></tr> <tr><td>3</td><td>10.744</td></tr> <tr><td>4</td><td>11.449</td></tr> <tr><td>5</td><td>12.157</td></tr> <tr><td>8</td><td>15.696</td></tr> </table>	1	9.328	2	10.035	3	10.744	4	11.449	5	12.157	8	15.696	
1	9.328																
2	10.035																
3	10.744																
4	11.449																
5	12.157																
8	15.696																









## FEATURES

- FourLikes Scooter including legs.
- Single back or double back options.
- Active seat height 48 cm (fits table height 74 cm).
- Only FourLikes Scooter 1400/2100: Electrical units are optional and will be positioned on the left or right side of sofas as standard.

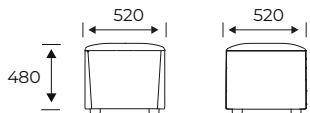

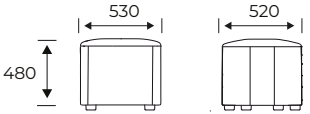
For product information visit [oceefour.com](https://oceefour.com) ↗

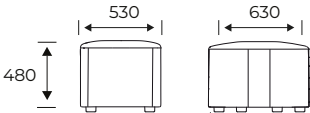

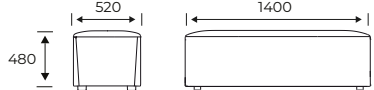
For full band and colour details [go to page 238](#) ↗

Product	Description (Item nr)	Weight (Kg)	Dimensions (mm)	Band	Same colour (SEK)
	<b>7024030</b> FourLikes® Scooter, Straight, 530, Without backs	9,5 Kg		1 2 3 4 5 8	5.326 5.842 6.361 6.876 7.391 9.976
	<b>7024130</b> FourLikes® Scooter, 45 degree, 530, Without backs	9,7 Kg		1 2 3 4 5 8	5.889 6.462 7.033 7.606 8.180 11.040
	<b>7024230</b> FourLikes® Scooter, 90 degree, 530, Without backs	10,4 Kg		1 2 3 4 5 8	6.773 7.431 8.088 8.745 9.400 12.686
	<b>7024010</b> FourLikes® Scooter, Straight, 1400, Without backs	26,4 Kg		1 2 3 4 5 8	9.554 11.044 12.531 14.024 15.511 22.959

# FourLikes® Scooter

Design by Nørsgaard Design

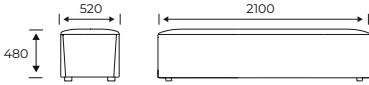
[Content ↗](#)

Product	Description (Item nr)	Weight (Kg)	Dimensions (mm)	Band	Same colour (SEK)
	<b>7024020</b> FourLikes® Scooter, Straight, 2100, Without backs	40,5 Kg		1 2 3 4 5 8	10.560 12.049 13.536 15.029 16.517 23.962
	<b>7024XXA</b> FourLikes® Scooter, Straight, 1400, 1 single back	2,1 Kg		1 2 3 4 5 8	1.938 2.103 2.268 2.432 2.597 3.420
	<b>7024XX1</b> FourLikes® Scooter, Straight, 1400, 1 double back	3,9 Kg		1 2 3 4 5 8	3.226 3.417 3.607 3.797 3.990 4.944

ACCESSORIES	Description	Weight (Kg)	Dimensions (mm)	Price (SEK)
	With Linking			416

# FourLikes® Wall bench

Design by Nørgaard Design

[Content ↗](#)



## FEATURES

- Wall-mounted (We recommend a sitting height of 46-48 cm.)
- Compact footprint for utilisation of all square metres
- We recommend at least two brackets per 140 cm
- We recommend a max. load of 150 kg. per 2 brackets as well as mounting on concrete/brick wall
- Backrest is supplied with a vertical wall mount bracket
- The seat is delivered without screws and brackets



For product information visit [oceefour.com](https://oceefour.com) ↗









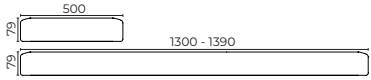

For full band and colour details [go to page 238](#) ↗

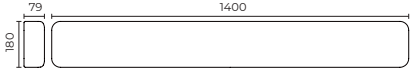
Product	Description (Item nr)	Weight (Kg)	Dimensions (mm)	Band	Same colour (SEK)
	<b>70331I</b> FourLikes® Wall Bench, Seat, 1400	9,2 Kg		<ul style="list-style-type: none"> <li>1 4.577</li> <li>2 5.460</li> <li>3 6.344</li> <li>4 7.228</li> <li>5 8.112</li> <li>8 12.526</li> </ul>	
	<b>70331A</b> FourLikes® Wall Bench, Seat, 1000-1090	(6,5 Kg)		<ul style="list-style-type: none"> <li>1 5.099</li> <li>2 5.923</li> <li>3 6.750</li> <li>4 7.575</li> <li>5 8.398</li> <li>8 12.524</li> </ul>	
	<b>70331B</b> FourLikes® Wall Bench, Seat, 1100-1190	(7,2 Kg)		<ul style="list-style-type: none"> <li>1 5.282</li> <li>2 6.152</li> <li>3 7.021</li> <li>4 7.891</li> <li>5 8.760</li> <li>8 13.107</li> </ul>	
	<b>70331C</b> FourLikes® Wall Bench, Seat, 1200-1290	(7,9 Kg)		<ul style="list-style-type: none"> <li>1 5.466</li> <li>2 6.389</li> <li>3 7.311</li> <li>4 8.233</li> <li>5 9.154</li> <li>8 13.763</li> </ul>	

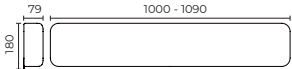
# FourLikes® Wall bench

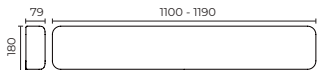
Design by Nørsgaard Design

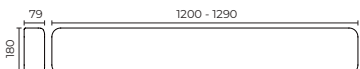
[Content ↗](#)

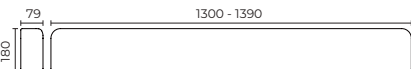
Product	Description (Item nr)	Weight (Kg)	Dimensions (mm)	Band	Same colour (SEK)
	<b>70331D</b> FourLikes® Wall Bench, Seat, 1300-1390	(8,5 Kg)		1 2 3 4 5 8	5.588 6.562 7.533 8.504 9.476 14.338
	<b>703321</b> FourLikes® Wall Bench, Backrest, 1400	2,6 Kg		1 2 3 4 5 8	5.382 6.204 7.026 7.846 8.667 12.775
	<b>70332A</b> FourLikes® Wall Bench, Backrest, 1000-1090	(1,8 Kg)		1 2 3 4 5 8	4.951 5.594 6.235 6.876 7.519 10.727
	<b>70332B</b> FourLikes® Wall Bench, Backrest, 1100-1190	(2 Kg)		1 2 3 4 5 8	5.094 5.775 6.459 7.142 7.823 11.235
	<b>70332C</b> FourLikes® Wall Bench, Backrest, 1200-1290	(2,2 Kg)		1 2 3 4 5 8	5.168 5.900 6.633 7.366 8.098 11.760
	<b>70332D</b> FourLikes® Wall Bench, Backrest, 1300-1390	(2,4 Kg)		1 2 3 4 5 8	5.310 6.084 6.860 7.636 8.410 12.285

ACCESSORIES	Description	Weight (Kg)	Dimensions (mm)	Price (SEK)
	With Bracket			1.507











FourUs®



FourUs® Booth



FourUs® Booth 2



FourUs® Work Booth



FourUs® Solo



FourUs® 3-Seater



FourUs® Wallpod



FourUs® Worx









## FEATURES



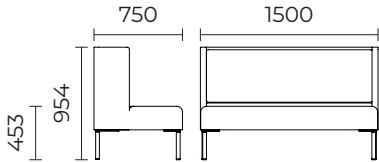

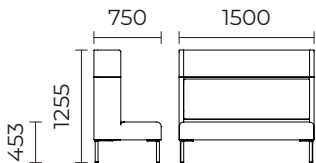

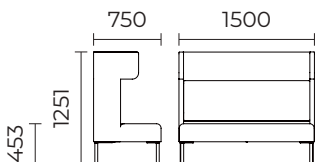

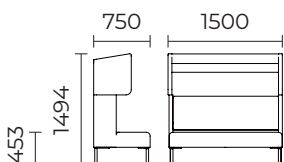
- Acoustic and visual privacy
- Linking options
- Uni- or Multicolored
- Facility friendly; designed for optimal cleaning
- Optional: Castors, Skid frame, InnoTab tablet, Magazine holder, Shelf (height 95 cm).
- Electrical units are optional and will be positioned on the left or right side of sofas as standard.

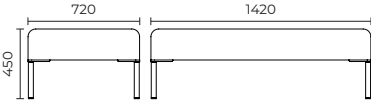
For product information visit [oceefour.com](https://oceefour.com) ↗

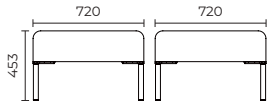
For electrical accessories [go to page 228](#) ↗

For full band and colour details [go to page 238](#) ↗

Product	Description (Item nr)	Weight (Kg)	Dimensions (mm)	Band	Same colour (SEK)	Different colour (SEK)
	<b>80000</b> FourUs®, Bench	52 kg		1 2 3 4 5 8	19.880 21.785 23.319 24.773 28.463 52.361	
	<b>80001</b> FourUs®, Extension	64 kg		1 2 3 4 5 8	24.812 26.944 28.659 30.263 34.884 64.583	
	<b>80002</b> FourUs®, Ear	58 kg		1 2 3 4 5 8	26.176 28.020 29.648 31.472 36.690 66.569	
	<b>80003</b> FourUs®, Cave	70 kg		1 2 3 4 5 8	30.253 32.423 34.440 36.461 43.179 81.938	

Product	Description (Item nr)	Weight (Kg)	Dimensions (mm)	Band	Same colour (SEK)	Different colour (SEK)
	<b>80004</b> FourUs®, Daybed	25 kg		1 2 3 4 5 8	10.081 10.767 11.310 11.897 13.693 21.514	
	<b>80005</b> FourUs®, Stool	16 kg		1 2 3 4 5 8	8.064 8.778 9.184 9.789 10.484 13.894	
	<b>80000-S</b> FourUs®, Bench, Seat			1 2 3 4 5 8		2.574 3.176 4.044 4.739 5.517 8.097
	<b>80000-C</b> FourUs®, Bench, Cushion			1 2 3 4 5 8		2.574 2.996 3.052 3.297 3.534 5.753
	<b>80001-T</b> FourUs®, Extension, Top			1 2 3 4 5 8		1.807 1.986 2.505 3.033 3.554 4.963
	<b>80002-T</b> FourUs®, Ear, Top			1 2 3 4 5 8		2.210 2.791 3.522 4.091 4.802 6.835
	<b>80003-T</b> FourUs®, Cave, Top			1 2 3 4 5 8		4.058 5.215 6.344 7.313 8.448 10.504

ACCESSORIES	Description	Weight (Kg)	Dimensions (mm)	Price (SEK)
	<b>FOURUS LEGS</b> Castors			3,960
	<b>FOURUS LEGS</b> Skid frame			3,742
	<b>160800L</b> InnoTab, FourUs, Left			3,872
	<b>160800R</b> InnoTab, FourUs, Right			3,872
	<b>899010</b> FourUs® Optional Extras, Magazine holder black, 30 cm	4,9 Kg	300 x 352 mm	1,089
	<b>899020</b> FourUs® Optional Extras, Magazine holder black, 70 cm	5,6 Kg	700 x 325 mm	1,484
	<b>899100</b> FourUs® Optional Extras, Shelf black	5,8 Kg	L1412 mm	5,949



# FourUs® Booth

Design by Nørgaard Design

[Content ↗](#)



## FEATURES





- Private working area for 4 people. Acoustic and visual privacy.
- Uni- or multicoloured.
- Facility friendly; designed for optimal cleaning.
- Optional: Pivot table that effortlessly moves both horizontally and vertically (Nano laminate: Warm grey, Anthracite or Black).
- Frame and fittings in black, matt lacquered.
- Optional: Skid frame, Magazine holder, Shelf (height 95 cm) TV bracket.
- Electrical units are optional in sofa and in tabletop.





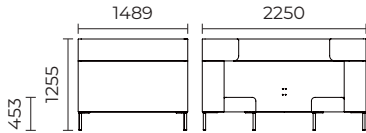



For product information visit [oceefour.com](https://oceefour.com) ↗

For electrical accessories [go to page 228](#) ↗

For full band and colour details [go to page 238](#) ↗

Product	Description (Item nr)	Weight (Kg)	Dimensions (mm)	Band	Same colour (SEK)	Different colour (SEK)
	<b>81002</b> FourUs® Booth,	154 kg		1 2 3 4 5	60.327 65.121 69.465 74.247 78.807	
	<b>81002-S</b> FourUs® Booth, 2 x Seat			1 2 3 4 5 8		5.146 5.961 7.945 9.565 11.189 16.057
	<b>81002-C</b> FourUs® Booth, 2 x Cushion			1 2 3 4 5 8		5.146 5.644 6.096 6.595 7.610 10.443
	<b>81002-T</b> FourUs® Booth, Top			1 2 3 4 5 8		4.421 4.860 5.239 5.841 6.901 11.322

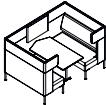
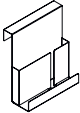
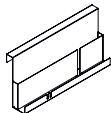
Product	Description (Item nr)	Weight (Kg)	Dimensions (mm)	Band	Same colour (SEK)	Different colour (SEK)
	<b>81003-C</b> FourUs® Booth, Cave			1		14.221
				2		17.442
				3		20.649
				4		23.267
				5		27.608

ACCESSORIES	Description	Weight (Kg)	Dimensions (mm)	Price (SEK)
	<b>CABLE MANAGEMENT</b> Pre-drilled hole in wall for cables for TV			345
	<b>CABLE MANAGEMENT</b> Fabric with velcro for concealing cable-right side			781
	<b>CABLE MANAGEMENT</b> Fabric with velcro for concealing cable, left side			781
	<b>FOURUS LEGS</b> Skid frame			3.742
	<b>160800L</b> InnoTab, FourUs, Left			3.872
	<b>160800R</b> InnoTab, FourUs, Right			3.872
	<b>8501</b> FourUs® Pivot Table, Pivot table 138x75 (FourUs Booth)	30,6 Kg	1388 x 750 x h720 mm	11.047
	<b>899001</b> FourUs® Optional Extras, TV bracket	-		3.176
	<b>899010</b> FourUs® Optional Extras, Magazine holder black, 30 cm	4,9 Kg	300 x 352 mm	1.089
	<b>899020</b> FourUs® Optional Extras, Magazine holder black, 70 cm	5,6 Kg	700 x 325 mm	1.484
	<b>899100</b> FourUs® Optional Extras, Shelf black	5,8 Kg	L1412 mm	5.949



# FourUs® Booth 2

Design by Nørgaard Design

[Content ↗](#)



## FEATURES





- Private working area for 2 people. Acoustic and visual privacy.
- Uni- or multicoloured.
- Facility friendly; designed for optimal cleaning.
- Optional: Pivot table that effortlessly moves both horizontally and vertically (Nano laminate: Warm grey, Anthracite or Black).
- Frame and fittings in black, matt lacquered.
- Optional: Skid frame, Magazine holder, Shelf (h 95 cm) TV bracket.
- Electrical units are optional in sofa and in tabletop.





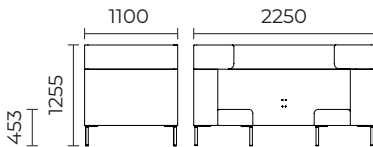

For product information visit [oceefour.com](https://oceefour.com) ↗

For electrical accessories [go to page 228](#) ↗

For full band and colour details [go to page 238](#) ↗

Product	Description (Item nr)	Weight (Kg)	Dimensions (mm)	Band	Same colour (SEK)	Different colour (SEK)
	<b>81042</b> FourUs® Booth 2,	-		1 2 3 4 5	48.260 52.098 55.574 59.397 63.046	
	<b>81042-S</b> FourUs® Booth 2, 2 x Seat			1 2 3 4 5 8		4.530 5.244 6.993 8.419 9.848 14.133
	<b>81042-C</b> FourUs® Booth 2, 2 x Cushion			1 2 3 4 5 8		4.530 4.967 5.366 5.806 6.695 9.189
	<b>81042-T</b> FourUs® Booth 2, Top			1 2 3 4 5 8		3.890 4.276 4.610 5.139 4.276 4.610

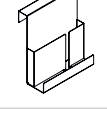
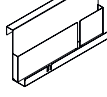
ACCESSORIES	Description	Weight (Kg)	Dimensions (mm)	Price (SEK)
	<b>CABLE MANAGEMENT</b> Pre-drilled hole in wall for cables for TV			345
	<b>CABLE MANAGEMENT</b> Fabric with velcro for concealing cable-right side			781
	<b>CABLE MANAGEMENT</b> Fabric with velcro for concealing cable, left side			781
	<b>FOURUS LEGS</b> Skid frame			3.742
	<b>160800L</b> InnoTab, FourUs, Left			3.872
	<b>160800R</b> InnoTab, FourUs, Right			3.872
	<b>8502</b> FourUs® Pivot Table, Pivot table 99x75 (FourUs Booth 2)	-		11.047
	<b>899001</b> FourUs® Optional Extras, TV bracket	-		3.176
	<b>899010</b> FourUs® Optional Extras, Magazine holder black, 30 cm	4,9 Kg	300 x 352 mm	1.089
	<b>899020</b> FourUs® Optional Extras, Magazine holder black, 70 cm	5,6 Kg	700 x 325 mm	1.484



## FEATURES





- Private working area for 1-3 people. Acoustic and visual privacy.
- Delivered left or right-handed. Uni- or multicoloured.
- Facility friendly; designed for optimal cleaning.
- Optional: Pivot table that effortlessly moves both horizontally and vertically (Nano laminate: Warm grey, Anthracite or Black).
- Frame and fittings in black, matt lacquered.
- Optional: Skid frame, Magazine holder, Shelf (h 95 cm) TV bracket.
- Electrical units are optional in sofa and in tabletop.

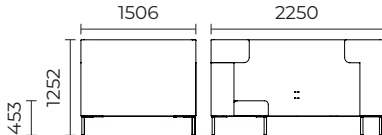

For product information visit [oceefour.com](https://oceefour.com) ↗

For electrical accessories [go to page 228](#) ↗

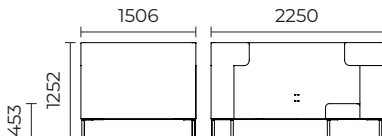



For full band and colour details [go to page 238](#) ↗





Product	Description (Item nr)	Weight (Kg)	Dimensions (mm)	Band	Same colour (SEK)	Different colour (SEK)
	<b>87062</b> FourUs® Work Booth right,	154 kg		1 2 3 4 5	50.711 55.821 60.930 66.040 71.149	
	<b>87072</b> FourUs® Work Booth left,	154 kg		1 2 3 4 5	50.711 55.821 60.930 66.040 71.149	
	<b>87062-S</b> FourUs® Work Booth right, Seat			1 2 3 4 5 8		2.574 2.981 3.973 4.784 5.597 8.030
	<b>87072-S</b> FourUs® Work Booth left, Seat			1 2 3 4 5 8		2.574 2.981 3.973 4.784 5.597 8.030

# FourUs® Work Booth

Design by Nørgaard Design

[Content ↗](#)

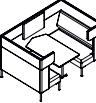
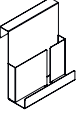
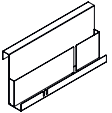
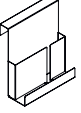
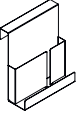
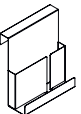
Product	Description (Item nr)	Weight (Kg)	Dimensions (mm)	Band	Same colour (SEK)	Different colour (SEK)
	<b>87062-C</b> FourUs® Work Booth right, Cushion			1		2.574
				2		2.823
				3		3.050
				4		3.297
				5		3.805
				8		5.222
	<b>87072-C</b> FourUs® Work Booth left, Cushion			1		2.574
				2		2.823
				3		3.050
				4		3.297
				5		3.805
				8		5.222
	<b>87062-T</b> FourUs® Work Booth right, Top			1		4.421
				2		4.860
				3		5.239
				4		5.841
				5		6.901
				8		11.322
	<b>87072-T</b> FourUs® Work Booth left, Top			1		4.421
				2		4.860
				3		5.239
				4		5.841
				5		6.901
				8		11.322

ACCESSORIES	Description	Weight (Kg)	Dimensions (mm)	Price (SEK)
	<b>CABLE MANAGEMENT</b> Pre-drilled hole in wall for cables for TV			345
	<b>CABLE MANAGEMENT</b> Fabric with velcro for concealing cable-right side			781
	<b>CABLE MANAGEMENT</b> Fabric with velcro for concealing cable, left side			781
	<b>8503</b> FourUs® Pivot Table, Pivot table (FourUs Work Booth) right	22,9 Kg	1361 x 842 x H720 mm	11.047
	<b>8504</b> FourUs® Pivot Table, Pivot table (FourUs Work Booth) left	22,9 Kg	1361 x 842 x H720 mm	11.047
	<b>899001</b> FourUs® Optional Extras, TV bracket	-		3.176
	<b>899010</b> FourUs® Optional Extras, Magazine holder black, 30 cm	4,9 Kg	300 x 352 mm	1.089
	<b>899020</b> FourUs® Optional Extras, Magazine holder black, 70 cm	5,6 Kg	700 x 325 mm	1.484
	<b>899030</b> FourUs® Optional Extras, Magazine holder black, 22,5 cm	-		2.839
	<b>899040</b> FourUs® Optional Extras, Magazine holder white, 22,5 cm	-		2.839
	<b>899050</b> FourUs® Optional Extras, Magazine holder grey, 22,5 cm	-		2.839
	<b>899100</b> FourUs® Optional Extras, Shelf black	5,8 Kg	L1412 mm	5.949

# FourUs® Solo

Design by Nørgaard Design

[Content ↗](#)



## FEATURES





- Acoustic and visual privacy. Uni- or multicoloured.
- Facility friendly; designed for optimal cleaning.
- Inclusive black Fenix-laminate tablet (21 mm) – placed on the right side as standard.
- Standard leg frame black (RAL 7021). Optional: Castors or Skid frame.
- Electrical units are optional and will be positioned on the left or right side of sofas as standard.

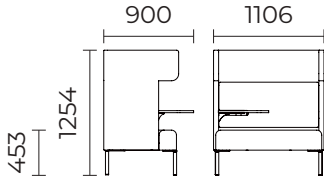

For product information visit [oceefour.com](https://oceefour.com) ↗

For electrical accessories [go to page 228](#) ↗

For full band and colour details [go to page 238](#) ↗

Product	Description (Item nr)	Weight (Kg)	Dimensions (mm)	Band	Same colour (SEK)	Different colour (SEK)
	<b>80016</b> FourUs® Solo with black tablet,	64 kg		1 2 3 4 5 8	25.783 27.601 29.203 31.004 36.139 65.571	
	<b>80016-S</b> FourUs® Solo with black tablet, Seat			1 2 3 4 5 8		2.512 2.923 2.975 3.218 3.451 6.683
	<b>80016-C</b> FourUs® Solo with black tablet, Cushion			1 2 3 4 5 8		2.512 2.923 2.975 3.218 3.451 6.683
	<b>80016-T</b> FourUs® Solo with black tablet, Top			1 2 3 4 5 8		2.337 3.093 3.786 4.564 5.269 7.450

# FourUs® Solo

Design by Nørgaard Design

[Content ↗](#)

ACCESSORIES	Description	Weight (Kg)	Dimensions (mm)	Price (SEK)
	<b>FOURUS LEGS</b> Castors			3.960
	<b>FOURUS LEGS</b> Skid frame			3.742



# FourUs® 3-Seater

Design by Nørsgaard Design

[Content ↗](#)



## FEATURES







- Acoustic and visual privacy. Uni- or Multicoloured.
- Facility friendly; designed for optimal cleaning.
- Optional: Skid frame, InnoTab tablet, Magazine holder, Shelf (height 95 cm).
- Electrical units are optional and will be positioned on the left or right side of sofas as standard.

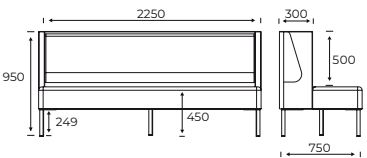

For product information visit [oceefour.com](https://oceefour.com) ↗

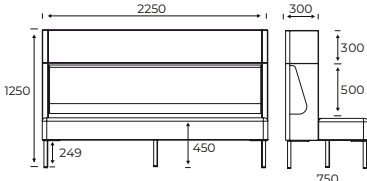
For electrical accessories [go to page 228](#) ↗

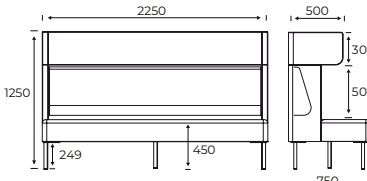

For full band and colour details [go to page 238](#) ↗

Product	Description (Item nr)	Weight (Kg)	Dimensions (mm)	Band	Same colour (SEK)	Different colour (SEK)
	<b>80030</b> FourUs® 3-Seater, Bench	-		1 2 3 4 5 8	29.253 31.129 32.817 34.692 38.441 55.882	
	<b>80031</b> FourUs® 3-Seater, Extension	-		1 2 3 4 5 8	34.562 36.567 38.253 39.849 44.536 66.478	
	<b>80032</b> FourUs® 3-Seater, Ear	62 Kg		1 2 3 4 5 8	35.817 37.878 39.567 41.289 45.849 67.788	
	<b>80030-S</b> FourUs® 3-Seater, Bench, Seat			1 2 3 4 5 8		3.095 4.078 4.855 5.822 6.778 9.901

# FourUs® 3-Seater

Design by Nørgaard Design

[Content ↗](#)

Product	Description (Item nr)	Weight (Kg)	Dimensions (mm)	Band	Same colour (SEK)	Different colour (SEK)
	<b>80030-C</b> FourUs® 3-Seater, Bench, Cushion			1		2.774
				2		2.993
				3		3.121
				4		3.392
				5		3.562
				8		6.315
	<b>80031-T</b> FourUs® 3-Seater, Extension, Top			1		2.776
				2		2.993
				3		3.544
				4		4.339
				5		5.138
				8		7.502
	<b>80032-T</b> FourUs® 3-Seater, Ear, Top			1		2.776
				2		2.993
				3		3.544
				4		4.339
				5		5.138
				8		7.502

ACCESSORIES	Description	Weight (Kg)	Dimensions (mm)	Price (SEK)
	<b>FOURUS LEGS</b> Skid frame			3.742
	<b>160800L</b> InnoTab, FourUs, Left			3.872
	<b>160800R</b> InnoTab, FourUs, Right			3.872
	<b>899010</b> FourUs® Optional Extras, Magazine holder black, 30 cm	4,9 Kg	300 x 352 mm	1.089
	<b>899020</b> FourUs® Optional Extras, Magazine holder black, 70 cm	5,6 Kg	700 x 325 mm	1.484



## FEATURES

- Acoustic and visual privacy
- Touch-Down-workspace (1 Person)
- Table top in: Black, warm grey or anthracite Nano laminate (138x50 cm)
- Matching ABS edges





For product information visit [oceefour.com](https://oceefour.com) ↗

## TABLE TOP

Fenix laminate

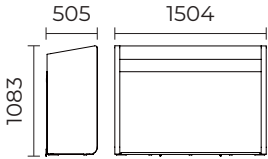

For full band and colour details [go to page 238](#) ↗

Product	Description (Item nr)	Weight (Kg)	Dimensions (mm)	Band	Same colour (SEK)
	<b>8200E</b> FourUs® Wallpod, Wallpod Ear	29 kg		<ul style="list-style-type: none"> <li>1 9.656</li> <li>2 10.198</li> <li>3 10.667</li> <li>4 11.182</li> <li>5 11.675</li> <li>8 16.518</li> </ul>	
	<b>8200F</b> FourUs® Wallpod, Wallpod Cave	35 kg		<ul style="list-style-type: none"> <li>1 17.477</li> <li>2 19.096</li> <li>3 20.571</li> <li>4 22.193</li> <li>5 23.741</li> <li>8 41.609</li> </ul>	



## FEATURES

- Table height 74 cm – integrated castors on two legs.
- Foldable by one person without the use of tools.
- Tabletop 98 x 65 cm.
- Table top in: Black, warm gray or anthracite Nano laminate.
- Matching ABS edges.
- Electrical units are optional in tabletop.

For product information visit [oceefour.com](https://oceefour.com) ↗

## TABLE TOP

Fenix laminate



## FRAME COLOURS

Standard

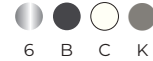

For electrical accessories [go to page 228](#) ↗

For full colour details [go to page 236](#) ↗

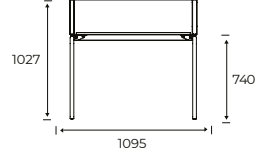
Product	Description (Item nr)	Weight (Kg)	Dimensions (mm)	Top/Band	Price (SEK)
	<b>83022</b> FourUs® Worx, FourWorx	28.4		1	17.562
				2	18.228
				3	18.776
				4	19.436
				5	20.071
				8	26.571

For tabletop cutout placements go to: [Oceedesign.com/Cutout.pdf](https://oceedesign.com/Cutout.pdf)







Harc Tub



Harc Tub Meeting

# Harc Tub

Design Roger Webb Associates

[Content ↗](#)



For data information, certificates and product description please refer to our website [www.fourdesign.dk](http://www.fourdesign.dk)



- Two-tone fabric option
- 5 star base is available on request







		Dimensions (cm)		Band	Price
	<b>HARCTUBLB1</b> Low Back Lounge Chair Skid Frame			1 2 3 4 5 6 7	11.186 11.573 12.151 12.922 14.277 15.818 17.366
	<b>HARCTUBLB2</b> Low Back Lounge Chair 4-star Polished Aluminium Swivel & Tilt Base			1 2 3 4 5 6 7	12.151 12.538 13.115 13.887 15.242 16.783 18.331
	<b>HARCTUBLB3</b> 18 Kg Low Back Lounge Chair Wooden Frame			1 2 3 4 5 6 7	16.012 16.399 16.977 17.749 19.103 20.645 22.192
	<b>HARCTUBHB1</b> High Back Lounge Chair Skid Frame			1 2 3 4 5 6 7	14.371 14.949 15.723 16.688 18.426 20.547 23.057
	<b>HARCTUBHB2</b> High Back Lounge Chair 4-star Polished Aluminium Swivel & tilt Base			1 2 3 4 5 6 7	15.336 15.914 16.688 17.652 19.391 21.512 24.022
	<b>HARCTUBHB3</b> High Back Lounge Chair Wooden Frame			1 2 3 4 5 6 7	19.198 19.775 20.549 21.514 23.252 25.373 27.883



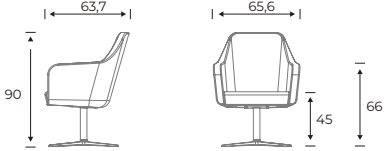

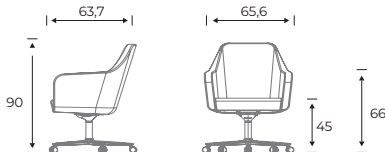

# Harc Tub Meeting

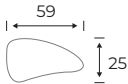
Design Roger Webb Associates

[Content ↗](#)

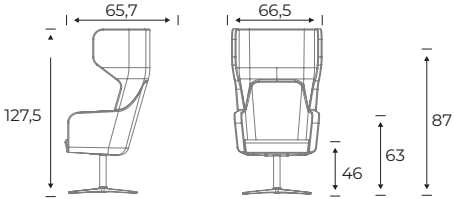
		Dimensions (cm)	Band	Price
	<b>HARCTUBMB2</b> Low Back Meeting Chair 4-star Polished Aluminium Swivel & Tilt Base		1	12.151
			2	12.538
			3	13.115
			4	13.887
			5	15.242
			6	16.783
			7	18.331
	<b>HARCTUBMB6</b> Low back meeting chair 5 star polished aluminium base with castors		1	11.186
			2	11.573
			3	12.151
			4	12.922
			5	14.277
			6	15.818
			7	17.366
	<b>HARCTUHR</b> Headrest option for all Harc Low Back Tub Chairs and Meeting Chairs		1	2.562
			2	2.688
			3	2.811
			4	2.965
			5	3.273
			6	3.616
			7	4.015
	<b>TABLET</b> Tablet option for Harc meeting with a 4 star base and Harc meeting with 5 star base and castors*			4.055

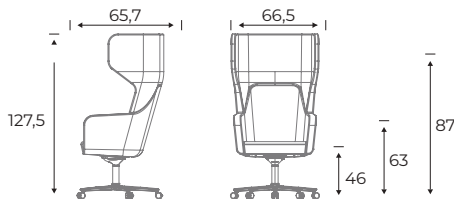
\*Tablet not available on 4 and 5 star base with swivel return option

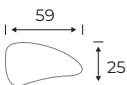
	<b>HARCTUBMH2</b> High back meeting chair 4-star polished aluminium swivel & tilt base		1	15.336
			2	15.914
			3	16.688
			4	17.652
			5	19.391
			6	21.512
			7	24.022
	<b>HARCTUBMH6</b> High back meeting chair 5-star polished aluminium base with castors		1	14.371
			2	14.949
			3	15.723
			4	16.688
			5	18.426
			6	20.547
			7	23.057
	<b>TABLET</b> Tablet option for Harc meeting with a 5 star base and castors*			4.055

\*Tablet not available on 4 and 5 star base with swivel return option

## Specifications & Options

- Low and high back option on all models
- Moulded foam for additional comfort and durability
- Two-tone fabric option
- Headrest option for all Harc Low Back tub chairs and Meeting chairs

## Frame options

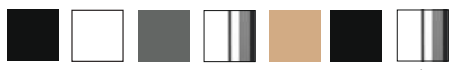



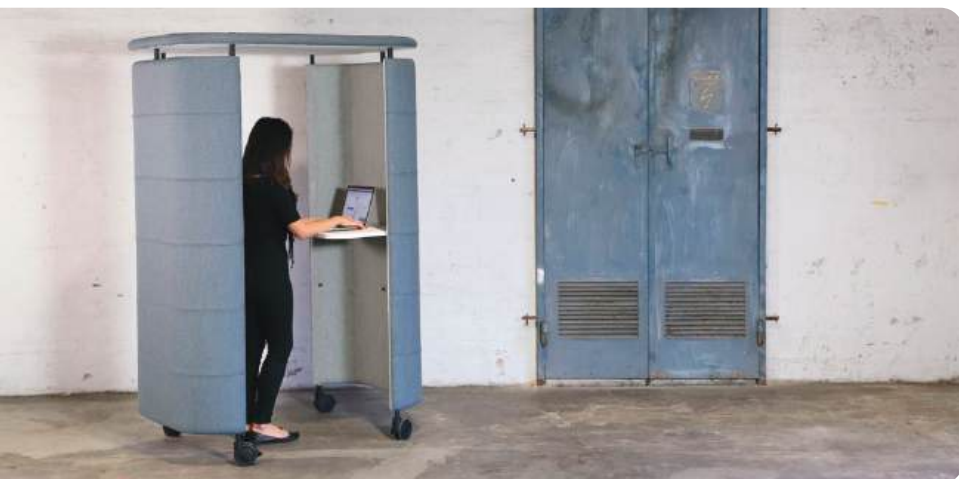

Black, White, Warm Grey, chrome, oak oiled, oak stained black, aluminium (chairs with swivel base only)



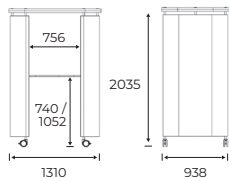

För datainformation, certifikat och produktbeskrivning, se vår webbplats [www.oceefour.com](http://www.oceefour.com)

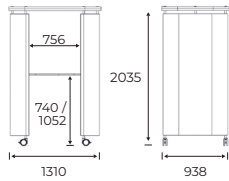

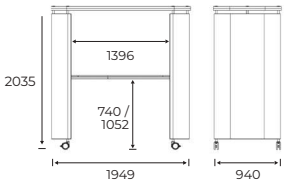
- Tillgänglig i två storlekar
- Två olika bordshöjder

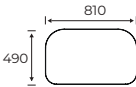
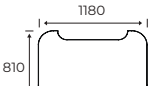
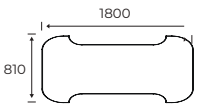
		Mått (mm)	Grupp	Pris
	<b>62000</b> Inno Pod Inkl. bordsskiva 81 x 49 cm 110 kg		1	27.037
			2	28.584
	<b>62001</b> Inno Pod Inkl. bordsskiva 81 x 118 cm 114 kg		1	28.485
			2	30.032
	<b>62003</b> Inno Pod Big Inkl. bordsskiva 81 x 180 cm 126 kg		1	35.504
			2	37.279

Tillbehör		Mått (mm)	Bordsskiva	Pris
	<b>62100</b> Bordsskiva (1 stolupphängning kan monteras)		07 ●	2.593
			08 ●	
			09 ●	
<b>62101</b> Bordsskiva (1 stolupphängning kan monteras)		07 ●	5.985	
		08 ●		
		09 ●		
<b>62103</b> Bordsskiva (Stolupphängning kan inte monteras)		07 ●	9.651	
		08 ●		
		09 ●		
	<b>CS1</b> Stolupphängning till FourCast2 Four, FourCast2 Line, FourSure 44, FourSure 88, FourSure 11, FourSure 99, Four Stools, Four Seating Benches 0,288kg			255
	<b>CS2</b> Stolupphängning till Four Cast Wheeler, Four Sure 66 0,288kg			255



# Let's furnish the world *better*

When we design a product, we consider every stage of the products lifecycle to ensure we are making responsible choices throughout all areas of the company. Each stage has the possibility to effect the next and so the whole picture is considered. Responsible manufacturing not only looks at the materials and where they are sourced, but also the manufacturing site and resources consumed; the use and durability of the product; the packaging and delivery service; as well as the product's end-of-life.

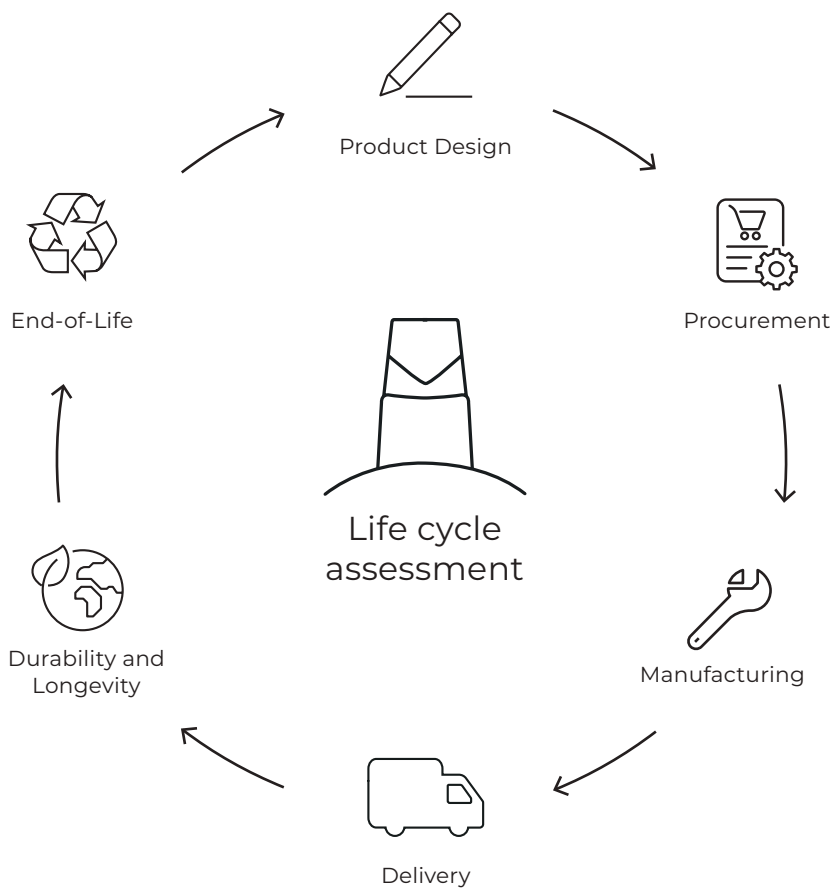



Our furniture are  
tested for Globally use









The following images are for illustrative purposes only. The finished product will contain standardised sockets based on the country of your choice. Please note prices include our team supplying products with prepared hole for unit installation. Please note, for tables, the electrical unit will be delivered separately, please follow the assembly instructions provided with your order to install the unit. For soft seating, the electrical unit will be preinstalled.

EVOLINE				PRICE (SEK)
	<p><b>EVOLINE ONE BLACK (APO00101)</b></p> <p>Ø60 Socket, 13 A, contactprotected. Power supply module with cable and connector, plug, cable length 3.0 m, black with lock. Power supply module with cable and connector, socket, cable length 3.0 m, black without lock.</p>	<p>FourReal® FourReal® A Four®Learning Four®Eating Four®Meeting Four®Mat FourLikes® T FourLikes® FourLikes® Meet FourLikes® Scooter (1400/2100)</p>	<p>FourUs® Work/Booth (tabletop) Harc Sofa/Modular Harc Booth tabletop FourPeople Sofas/Booths/Huts</p>	1.865
	<p><b>EVOLINE ONE WHITE (APO00102)</b></p> <p>Ø60 Socket, 13 A, contactprotected. Power supply module with cable and connector, plug, cable length 3.0 m, black with lock. Power supply module with cable and connector, socket, cable length 3.0 m, black without lock.</p>	<p>FourReal® FourReal® A Four®Learning Four®Eating Four®Meeting Four®Mat FourLikes® T FourLikes® FourLikes® Meet FourLikes® Scooter (1400/2100)</p>	<p>FourUs® Work/Booth (tabletop) Harc Sofa/Modular Harc Booth tabletop FourPeople Sofas/Booths/Huts</p>	1.865
	<p><b>EVOLINE ONE USB BLACK (APO00201)</b></p> <p>USB socket, charging function only. Rated output current: 2100 mA; Type A + C. Power supply module with cable and connector, plug, cable length 3.0 m, black with lock. Power supply module with cable and connector, socket, cable length 3.0 m, black without lock.</p>	<p>FourReal® FourReal® A Four®Learning Four®Eating Four®Meeting Four®Mat FourLikes® T FourLikes® FourLikes® Meet FourLikes® Scooter (1400/2100)</p>	<p>FourUs® Work/Booth (tabletop) Harc Sofa/Modular Harc Booth tabletop FourPeople Sofas/Booths/Huts</p>	2.566
	<p><b>EVOLINE ONE USB WHITE (APO00202)</b></p> <p>USB socket, charging function only. Rated output current: 2100 mA; Type A + C. Power supply module with cable and connector, plug, cable length 3.0 m, black with lock. Power supply module with cable and connector, socket, cable length 3.0 m, black without lock.</p>	<p>FourReal® FourReal® A Four®Learning Four®Eating Four®Meeting Four®Mat FourLikes® T FourLikes® FourLikes® Meet FourLikes® Scooter (1400/2100)</p>	<p>FourUs® Work/Booth (tabletop) Harc Sofa/Modular Harc Booth tabletop FourPeople Sofas/Booths/Huts</p>	2.566
	<p><b>EVOLINE FRAMEDOCK BLACK (APF301010102)</b></p> <p>2 x Socket Modules, 13 A, contactprotected. 1 x Socket Modules, USB socket, charging function only. Rated output current: 2100 mA; Type A + C. Power supply module with cable and connector, plug, cable length 3.0 m, black with lock. Power supply module with cable and connector, socket, cable length 3.0 m, black with lock.</p>	<p>FourReal® FourReal® A Four®Learning Four®Eating Four®Meeting Four®Mat</p>		3.370
	<p><b>EVOLINE FRAMEDOCK SILVER ANODISED (APF303010102)</b></p> <p>2 x Socket Modules, 13 A, contactprotected. 1 x Socket Modules, USB socket, charging function only. Rated output current: 2100 mA; Type A + C. Power supply module with cable and connector, plug, cable length 3.0 m, black with lock. Power supply module with cable and connector, socket, cable length 3.0 m, black with lock.</p>	<p>FourReal® FourReal® A Four®Learning Four®Eating Four®Meeting Four®Mat</p>		3.370

EVOLINE

PRICE (SEK)



**EVOLINE DOCKFIX BLACK  
(APD3010102)**

2 x Socket Modules, 13 A, contactprotected. 1 x Socket Modules, USB socket, charging function only. Rated output current: 2100 mA; Type A + C.  
Power supply module with cable and connector, plug, cable length 3.0 m, black with lock.  
Power supply module with cable and connector, socket, cable length 3.0 m, black with lock.  
With sidebrackets for sub-mounting.

FourUs®  
FourUs® Booth  
FourUs® Work Booth  
FourUs® Solo  
FourUs® 3 Seater  
FourUs® Corner

3,668



**CHAIRS**

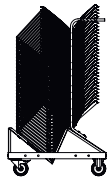

**CHAIR TROLLEY - 200X0**

Chair trolley for:

FourSure® 44  
 FourSure® 44 Armrest  
 FourSure® 88  
 FourSure® 88 Armrest  
 FourCast® 2 Four  
 FourCast® 2 Four Armrest  
 FourCast® 2 Line  
 FourCast® 2 Line Armrest

200A0  
 200CO  
 200FO  
 200IO

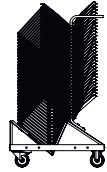

**CHAIR TROLLEY - 200X0**

Chair trolley for:

FourCast® 2 Four Seat/Fully  
 FourCast® 2 Four Seat/Fully Arm  
 FourCast® 2 Line Seat/Fully  
 FourCast® 2 Line Seat/Fully Arm  
 FourCast® 2 Line Veneer  
 FourSure® 44 Inside/Seat/Fully  
 FourSure® 44 Seat/Arm  
 FourSure® 44 Inside/Arm  
 FourSure® 88 Seat  
 FourSure® 88 Inside  
 FourSure® 88 Seat/Inside Arm  
 Share Basic without / seat upholstery

20020  
 20030  
 20060  
 20090  
 20070  
 200B0  
 200E0  
 200D0  
 200G0  
 200H0  
 200J0  
 20060



**SACK TROLLEY - 200X1**

Chair trolley for:

FourCast® 2 Four  
 FourCast® 2 Line  
 FourSure® 44  
 FourSure® 88

20011  
 20051  
 200A1  
 200F1

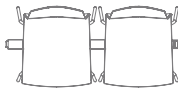

**LINKING DEVICE**

Chair linking under seat

FourCast® 2 Four/Seat  
 FourCast® 2 Line/Seat  
 FourSure® 44  
 FourSure® 88  
 FourCast® 2 Four/Fully  
 FourCast® 2 Line/Fully  
 FourSure® 44 Seat/Inside  
 FourSure® 88 Seat/Inside



**LINKING DEVICE**

Chair linking on frame

FourCast® 2 Line  
 FourSure® 88

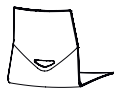

**GRIP HOLE**

Grip hole is available for chairs without inside – and full upholstery.

GRIP

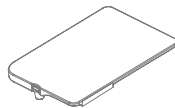

**INNO**

Inno® Note – A slim writing tablet matches a 13" laptop and has integrated cupholder. 225 x 325 x 10 mm (1,4 kg)

FourCast® 2 Four  
 FourCast® 2 Line  
 FourSure® 44  
 FourSure® 88



**INNO**

Inno® Tab - Writing tablet with integrated with integrated cup holder and dashboard for tablet and phone. 520 x 320 x 23 mm (2,7 kg)

FourCast® 2 Wheeler  
 FourSure® 66  
 FourMe® 66  
 FourCast® 2 Audi  
 FourSure® Audi

CHAIRS

	<p><b>INNO®NOTE TROLLEY - 20100007</b> Trolley for Inno®Note. Room for 51 Inno®Notes</p>	<p>FourCast® 2 Four FourCast® 2 Line FourSure® 44 FourSure® 88</p>	<p>20100007</p>
	<p><b>INNO</b> Inno® Tab B – Writing tablet and powder coated frame with integral cup holder and coat hook. 585 x 308 mm.</p>	<p>White Antchracite</p>	
	<p><b>INNO</b> Inno® Tab C – Writing tablet and powder coated frame with integral cup holder and coat hook. 475 x 278 mm.</p>	<p>White Antchracite</p>	
	<p><b>HOOK</b></p>	<p>FourCast2® Wheeler FourSure® 66</p>	
	<p><b>GASFOOT</b> Incl. foot ring</p>	<p>FourCast® 2 Wheeler FourSure® 66 FourMe® 66</p>	<p>GASFOOT GASFOOT GASFOOT</p>
	<p><b>WHEELS</b></p>	<p>FourCast® 2 Evo FourCast® 2 XL/XL Plus FourSure® 99 FourMe® 99</p>	
	<p><b>STANDARD POLYIMIDE GLIDES</b> Chair height + 0,2 cm</p>	<p>FourCast® 2 Wheeler FourSure® 66 FourMe® 66</p>	
	<p><b>TEFLON GLIDERS</b> Set of 4 pcs. Chair height + 0,2 cm</p>	<p>FourCast® 2 Four / Eco FourCast® 2 Line / Eco FourCast® 2 Counter/High / Eco FourCast® 2 Counter/High Four / Eco FourCast® 2 One FourSure® 44 / Eco FourSure® 88 / Eco FourSure® 90/105 / Eco FourSure® 11 + FourSure® 99 FourMe® 44 + FourMe® 88 FourMe® 11 + FourMe® 99 Four® Stools Four® Seating Benches</p>	
	<p><b>FELT GLIDES</b> Set of 4 pcs. Chair height + 0,2 cm</p>	<p>FourCast® 2 Four / Eco FourCast® 2 Line / Eco FourCast® 2 Counter/High / Eco FourCast® 2 Counter/High Four / Eco FourCast® 2 One FourCast® 2 Evo FourCast® 2 XL/Plus FourCast® 2 Lounge FourSure® 44 / Eco FourSure® 88 / Eco FourSure® 90/105 / Eco FourSure® 11 + FourSure® 99 FourMe® 44 + FourMe® 88 FourMe® 11 + FourMe® 99 FourMe® Lounge</p>	
	<p><b>FELT GLIDES FOR WOODEN LEGS</b> Set of 4 pcs. Chair height + 0,2 cm.</p>	<p>FourCast® 2 Four FourSure® 44 FourMe® 44</p>	

CHAIRS

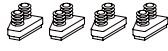

**FELT GLIDES  
STOOLS & BENCHES  
WOODEN LEGS**  
4-pack. Sitthöjd + 0,2 cm

Four® Stools wooden legs  
Four® Seating Benches wooden legs



**FEET/GLIDERS/CASTORS**  
Noise reducing ferrule with felt.  
Set of 4 pcs. Chair height + 1 cm

FourCast® 2 Four  
FourCast® 2 One  
FourSure® 44  
FourSure® 11  
FourMe® 44  
FourMe® 11

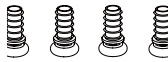

**FEET/GLIDERS/CASTORS**  
Noise reducing ferrule with big  
diameter (reduces pressure marks).  
Set of 4 pcs. Chair height + 0,8 cm

FourCast® 2 Four  
FourCast® 2 One  
FourSure® 44  
FourSure® 11  
FourMe® 44  
FourMe® 11



**CHAIR SEAT-ROW -  
ACSR0201**  
11 mm - no. 1 - 25

FourCast® 2 Line  
Eco Label FourCast® 2 Line  
Fire Retardent FourCast® 2 Line  
FourSure® 88  
Eco Label FourSure® 88

ACSR0201



**CHAIR SEAT-ROW -  
ACSR0202**  
11 mm - no. 26 - 50

FourCast® 2 Line  
Eco Label FourCast® 2 Line  
Fire Retardent FourCast® 2 Line  
FourSure® 88  
Eco Label FourSure® 88

ACSR0202



**CHAIR SEAT-ROW -  
ACSR0101**  
16 mm - no. 1 - 25

FourCast® 2 Four  
Eco Label FourCast® 2 Four  
Fire Retardent FourCast® 2 Four  
FourSure® 44  
Eco Label FourSure® 44

ACSR0101













**CHAIR SEAT-ROW -  
ACSR0102**  
16 mm - no. 26 - 50

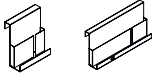

FourCast® 2 Four  
Eco Label FourCast® 2 Four  
Fire Retardent FourCast® 2 Four  
FourSure® 44  
Eco Label FourSure® 44

ACSR0102



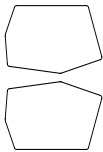

TABLES			
	<p><b>TABLE TROLLEY - 20100001</b> Trolley for 10 folded tables or 7 round tables, including strap. 20 Kg. L: 172 x W: 55 x H: 98 cm Folded Table: 15 cm</p>	<p>Four® Learning Four® Eating FourReal® 74 FourReal® 90 FourReal® 105 FourReal® 741 Flake</p>	<p>20100001 20100001 20100001 20100001 20100001 20100001</p>
	<p><b>CHAIR SUSPENSION</b> Chair suspension for FourCast2 Four, FourCast2 Line, FourSure 44, FourSure 88, FourSure 11, FourSure 99, Four Stools, Four Seating Benches</p>	<p>Four® Learning Four® Eating Four® Meeting FourReal® 74 FourReal® 90 FourReal® 105 FourReal® 741 Flake</p>	<p>CS1</p>
	<p><b>CHAIR SUSPENSION</b> Chair suspension for FourCast2 Wheeler, FourSure 66</p>	<p>Four® Learning Four® Eating Four® Meeting FourReal® 74 FourReal® 90 FourReal® 105 FourReal® 741 Flake</p>	<p>CS2</p>
	<p><b>CABLE CUT OUT</b> Cable duct, aluminum. Cable duct placed in apron</p>	<p>Four® Learning Four® Eating Four® Meeting FourReal®</p>	<p>CD</p>
	<p><b>CD</b> Cable duct, single, incl., hole in table top. Aluminium.</p>	<p>Four® Mat</p>	<p>CD1</p>
	<p><b>CD</b> Cable duct, double, incl., hole in table top. Aluminium.</p>	<p>Four® Mat</p>	<p>CD2</p>
	<p><b>FRLINK</b> Linking Device, set of 4 pcs - 2 x he, 2 x she per table</p>	<p>Four® Learning Four® Eating Four® Meeting FourReal®</p>	
	<p><b>CASTORS</b> Castors height adjustable wheel in black with brakes. Set of 4 pieces</p>	<p>FourFold®</p>	<p>CF</p>
	<p><b>CASTORS</b></p>	<p>Four® Resting</p>	
	<p><b>HOLE</b> Pre-drilled hole for power</p>	<p>All tables</p>	
<p>60 cm x 13 cm x 15 cm 80 cm x 13 cm x 15 cm</p>	<p><b>FLOWER BOX</b> FourReal A 74 + 90 FourReal A.XL 74 + 90 FourReal AV</p>	<p>Black 600 mm Black 800 mm</p>	<p>699000008 699000005</p>
	<p><b>TOP-SHELF</b> FourReal A 74 + 90 FourReal A.XL 74 + 90 FourReal AV</p>	<p>White 600 mm x 205 mm Black 600 mm x 205 mm Grey 600 mm x 205 mm</p>	<p>699000001 699000002 699000003</p>

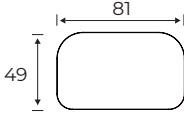
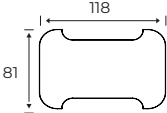
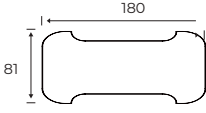
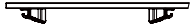
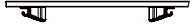
SOFT SEATING			
	<b>LINKING DEVICE</b> 2 her x 2 him	FourLikes®	
	<b>LINKING DEVICE</b> Linking Device	FourLikes® Scooter	
	<b>FEET</b> Feet for FourLikes Scooter	FourLikes® Scooter	
	<b>WHEELS</b>	FourLikes® Scooter	
	<b>INNO® TAB LEFT</b> Black Fenix-Laminate <i>*Only with standard legs</i> L: 480 x W: 300 mm	FourUs® FourUs® 3-seater FourUs® Booth 2 FourUs® Booth	16082-1A1-92
	<b>INNO® TAB RIGHT</b> Black Fenix-Laminate <i>*Only with standard legs</i> L: 480 x W: 300 mm	FourUs® FourUs® 3-seater FourUs® Booth 2 FourUs® Booth	16072-1A1-92
	<b>SHELF</b> Black Fenix-Laminate L: 1500 x W: 300 mm Heigh from floor: 905 mm	FourUs® FourUs® Booth FourUs® Work Booth	8990J-101-13
	<b>CASTORS</b>	FourUs® FourUs® Solo	8990K-100-00
	<b>SKID FRAME</b>	FourUs® FourUs® 3-seater FourUs® Booth 2 FourUs® Booth FourUs® Corner FourUs® Solo	8990M-500-00
	<b>MAGAZINE HOLDER</b> W: 300 mm / 700 mm	FourUs® FourUs® 3-seater FourUs® Booth 2 FourUs® Booth FourUs® Corner FourUs® Work Booth	8990T-000-99 / 8990T-001-99
	<b>MAGAZINE HOLDER, BLACK</b> B: 225 x D: 95 x H: 970 mm	FourUs® Booth FourUs® Booth 2 FourUs® Work Booth	8990T-B00-99
	<b>MAGAZINE HOLDER, WHITE</b> B: 225 x D: 95 x H: 970 mm		8990T-C00-99
	<b>MAGAZINE HOLDER, GREY</b> B: 225 x D: 95 x H: 970 mm		8990T-K00-99
	<b>PIVOT TABLE</b> Black Fenix-laminate	FourUs® Booth 2 FourUs® Booth	85045





SOFT SEATING					
	<b>PIVOT TABLE, RIGHT</b> L: 1380 x B: 750 x H: 720 mm	FourUs® Work Booth			870GS-106
	<b>PIVOT TABLE, LEFT</b> L: 1380 x B: 750 x H: 720 mm				870GS-107
	<b>TV BRACKET</b> Option hidden cable	FourUs® Booth 2 FourUs® Booth FourUs® Work Booth			8100T-100-00
	<b>CABLE MANAGEMENT TV</b> Pre-drilled hole in wall for cables	FourUs® Booth 2 FourUs® Booth FourUs® Work Booth			
	<b>CABLE MANAGEMENT STANDARD</b> Fabric with velcro for concealing cable underneath the table	FourUs® Booth 2 FourUs® Booth FourUs® Work Booth			
ACOUSTIC					
	<b>TABLE TOP</b> (1 pcs. chair suspension) Colours: 08 Warm grey, 38 Antracit, 10 Black	InnoPod®	08 ● 38 ● 10 ●		62100
	<b>TABLE TOP</b> (1 pcs. chair suspension) Colours: 08 Warm grey, 38 Antracit, 10 Black	InnoPod®	08 ● 38 ● 10 ●		62101
	<b>TABLE TOP</b> (No chair suspension) Colours: 08 Warm grey, 38 Antracit, 10 Black	InnoPod®	08 ● 38 ● 10 ●		62103
	<b>CS1</b> Chair suspension for FourCast2 Four, FourCast2 Line, FourSure 44, FourSure 88, FourSure 11, FourSure 99, Four Stools, Four Seating Benches	InnoPod®			23099-002-99
	<b>CS2</b> Chair suspension for FourCast2 Wheeler, FourSure 66	InnoPod®			23099-003-99

Chair shell colours





 <b>01 / SNOW</b> RAL 9010	 <b>14 / WHITE</b> Fire Retardant RAL 9010	 <b>02 / EBONY BLACK</b> NCS S 9000-N	 <b>03 / ANTHRACITE</b> RAL 7015
 <b>05 / AQUA</b> NCS S 4020-B	 <b>17 / PINE</b> NCS S 5005-B80G	 <b>18 / MOSS</b> NCS S 5010-G70Y	 <b>12 / TERRACOTTA</b> NCS S 4510-Y60R
 <b>13 / CLAY</b> NCS S 6005-Y20R	 <b>10 / BEACH</b> NCS S 2502-Y	 <b>09 / OLIVE</b> NCS S 2040-G80Y	 <b>08 / ORANGE</b> NCS S 2070-Y70R
 <b>07 / ORIENTAL RED</b> NCS S 1580-R	 <b>06 / JUNGLE GREEN</b> NCS 4050-G40Y	 <b>31 (03) / OAK</b>	 <b>32 (04) / OAK BLACK</b>

Chair frame colours

 <b>C (02) / MATT WHITE</b> RAL 9010	 <b>B (01) / MATT BLACK</b> RAL 7021	 <b>K (03) / STONE GREY</b> RAL 7039	 <b>9 / BLACK</b>
 <b>E / ANTHRACITE</b> RAL 7024 gl.5	 <b>M / AQUA</b> S4020-B IGP 581 TA 52240 A 00	 <b>D / PINE</b> IGP 591 TA 79407 R10	 <b>F / MOSS</b> IGP 591 TA 64445 R10
 <b>7 / TERRACOTTA</b> IGP 591 TA 83991 R10	 <b>A / CLAY</b> IGP 591 TA 79406 R10	 <b>T / BEACH</b> IGP 681 TA 77644 A 00	 <b>S / OLIVE</b> RAL 7042 gl. 5
 <b>N / ORANGE</b> IGP 681 TA 21349 A 00	 <b>Q / ORIENTAL RED</b> IGP 581 TA 33080 A 00	 <b>O / JUNGLE GREEN</b> IGP 681 TA 64014 A 00	
 <b>4 / ALUMINIUM</b>	 <b>5 / MAT CHROME</b>	 <b>6 / CHROME</b>	
 <b>P / OAK</b> BLACK OILED	 <b>V / OAK</b> LACQUERED BLACK	 <b>L / OAK OILED</b>	 <b>U / OAK CLEAR</b> MATT LACQUERED

Share colours

SHARE SEAT/BACK COLOURS







 <b>19 / DENIM</b> NCS S 6020-B10G	 <b>20 / CLARET</b> NCS S 7010-R10B
 <b>02 / EBONY BLACK</b> NCS S 9000-N	 <b>13 / CLAY</b> NCS S 6005-Y20R
	 <b>10 / BEACH</b> NCS S 2502-Y

SHARE BACK COVER COLOURS

 <b>19 / DENIM</b> NCS S 6020-B10G	 <b>20 / CLARET</b> NCS S 7010-R10B	 <b>21 / TEAL</b> NCS S 5030-B10G	 <b>22 / ROSE</b> NCS S 2040-R20B
 <b>02 / EBONY BLACK</b> NCS S 9000-N	 <b>13 / CLAY</b> NCS S 6005-Y20R	 <b>10 / BEACH</b> NCS S 2502-Y	

## Tabletops



---

 <b>01 / WHITE W980 LAMINATE</b>	 <b>02 / LIGHT GREY EGGER U763 LAMINATE</b>	 <b>03 / GREY EGGER U732 LAMINATE</b>
 <b>04 / WHITE W980 DECOR</b>	 <b>05 / LIGHT GREY EGGER U763 DECOR</b>	 <b>06 / GREY EGGER U732 DECOR</b>
 <b>07 / WARM GREY ARPA FENIX NANO 0718</b>	 <b>08 / ANTRACIT ARPA FENIX NANO 0724</b>	 <b>09 / BLACK ARPA FENIX NANO 0720</b>
 <b>10 / BLACK 4023 LINOLEUM</b>	 <b>20 / WHITE COMPACT LAMINATE F2255</b>	

### FOUR MAT TABLE

 <b>71 / MAPLE VENEER</b>	 <b>72 / WALNUT VENEER</b>
 <b>70 / BEECH VENEER</b>	 <b>79 / OAK VENEER</b>

### HARC TUB TABLE

 <b>68 / BLACK LAMINATE</b>
 <b>43 / OAK LAMINATE</b>

### OUTDOOR TABLETOPS





 <b>20 / WHITE COMPACT LAMINATE F2255</b>	 <b>57 / LIGHT GREY COMPACT LAMINATE F7927</b>
--	---

## Table frames

---

 <b>C / MATT WHITE RAL 9010</b>	 <b>B / MATT BLACK RAL 7021</b>	 <b>K / STONE GREY RAL 7039</b>
 <b>E / ANTHRACITE RAL 7024 gl.5</b>	 <b>6 / CHROME</b>	 <b>4 / ALUMINIUM</b>
 <b>V / OAK LACQUERED BLACK</b>	 <b>U / OAK CLEAR MATT LACQUERED</b>	

### OUTDOOR FRAMES

 <b>H / WHITE SMOOTH</b>	 <b>J / WHITE ROUGH</b>	 <b>G / BLACK SMOOTH</b>	 <b>I / BLACK ROUGH</b>
---	--	---	--

This is just a selection of the cover options available. We are able to source alternative fabrics. Please contact info@fourdesign.dk for details.

**Disclaimer** – This fabric can be used on the listed products, but we believe that a better finish can be achieved from other fabric selections.

**Shade** – Only certain shades of the fabric are appropriate for use on these products. Please contact us for details.

**Sample** – Our upholstery experts will sample the suitability of this material range upon request.

FABRIC SUPPLIERS:

www.camirafabrics.com, www.gabriel.dk, www.kvadrat.dk

**InnoPod®**

**Band 1**

Go Check, Main Line Flax, Main Line Plus, Patina, Step Melange

**Band 2**

Crisp, Europost2, Fame, Select, Chili, Nejma, Passion

**Fabricks™**

**Band 3**

Blazer Lite, \*Blazer

























































































**Tessellate**





**Band 1:** Tempt

**Band 3:** Blazer Lite

**Band 5:** Canvas

	Sustainability factor	Soft Seating/ RoomInRoom	Harc Tub High Back/FourLikes Meet 1400+700	Fully Upholstered FourCast/FourSure	FourMe	Seat & Inner Upholstered FourCast/FourSure
<b>Band 1</b>						
Aspect	Camira ♥ ♻️ ↓	Yes	Yes	Yes	Yes	Yes
Advantage	Camira ♥ ♻️	Yes	Yes	Yes	Yes	Yes
Atlas	Kvadrat ♥ ♻️	Yes	Shade	Shade	Shade	Shade
Canopy	Camira ♥ ♻️	Yes	FLM 700+1400 only	Yes	Yes	Yes
Clara 2	Kvadrat ♥ ♻️	Yes	Shade	Yes	Yes	Yes
Connect	Gabriel ♥ ♻️ ♻️ ↓	Yes	Yes	Yes	Yes	Yes
Cura	Gabriel ♥ ♻️ ♻️ ↓	Yes	SHADE	Yes	Yes	Yes
Era	Camira ♥ ♻️	Yes	Yes	Yes	Yes	Yes
Event	Gabriel ♥ ♻️	No	No	Yes	Yes	Yes
Felicity	Gabriel ♥ ♻️ ♻️ ↓	Yes	SHADE	Yes	Yes	Yes
Field 2	Kvadrat ♥ ♻️ ↓	Disclaimer	No	Disclaimer	Disclaimer	Yes
Go Check	Gabriel ♥ ♻️ ↓	Yes	SHADE	Yes	Yes	Yes
Go Couture	Gabriel ♥ ♻️ ↓	Yes	SHADE	Yes	Yes	Yes
Go Uni	Gabriel ♥ ♻️ ↓	Yes	SHADE	Yes	Yes	Yes
Gravity	Camira ♥ ♻️ ↓	No	No	Disclaimer	Disclaimer	Disclaimer
Halcyon Aspen	Camira ♥	Yes	No	Yes	No	Yes
Halcyon Blossom	Camira ♥	Yes	No	Yes	No	Yes
Halcyon Cedar	Camira ♥	Yes	No	Yes	No	Yes
Main Line Plus	Camira ♥	Yes	Yes	Yes	Yes	Yes
Main Line Flax	Camira ♥ ♻️	Yes	Yes	Yes	Yes	Yes
Manila	Camira ♥	Yes	No	Yes	No	Yes
Manhattan	Camira ♥ ♻️ ♻️ ↓	Yes	No	Yes	Yes	Yes
Patina	Camira ♥ ♻️ ♻️ ↓	Yes	Yes	Yes	Yes	Yes
Phoenix	Camira ♥ ♻️ ♻️ ↓	No	No	Disclaimer	Disclaimer	Disclaimer
Quest	Camira ♥ ♻️ ♻️ ↓	Yes	Yes	Yes	Yes	Yes
Repetto	Gabriel ♥ ♻️ ♻️ ↓	Yes	SHADE	Yes	Yes	Yes
Rivet	Camira ♥ ♻️ ♻️ ↓	No	No	Disclaimer	Disclaimer	Disclaimer
Step	Gabriel ♥ ♻️ ♻️ ↓	Yes	Yes	Yes	Yes	Yes
Step Melange	Gabriel ♥ ♻️ ♻️ ↓	Yes	Yes	Yes	Yes	Yes
Tempt	Gabriel ♥ ♻️ ♻️ ↓	Yes	shade	Yes	Yes	Yes
Tonal	Gabriel ♥ ♻️ ♻️ ↓	Sample	Sample	Yes	Yes	Sample
Urban	Camira ♥ ♻️ ♻️ ↓	No	No	No	No	Yes
Vita Vinyl	Camira ♥	Yes	Sample	Yes	No	Yes
Valencia	Spradling ♥	Yes	Harc Tub only	Yes	No	Yes
Xtreme	Camira ♥ ♻️ ♻️ ↓	Yes	Yes	Yes	Yes	Yes
<b>Band 2</b>						
Aquarius	Camira ♥ ♻️ ♻️ ↓	Yes	Yes	Yes	Yes	Yes
Blazer*	Camira ♥ ♻️ ♻️ ↓	Yes	Yes	Yes	Yes	Yes
Chili	Gabriel ♥ ♻️ ♻️ ↓	Yes	Yes	Yes	Yes	Yes
Contour	Gabriel ♥ ♻️ ♻️ ↓	Sample	Sample	Sample	Sample	Sample
Crisp	Gabriel ♥ ♻️ ♻️ ↓	Yes	Yes	Yes	Yes	Yes
Deca	Camira ♥ ♻️ ♻️ ↓	Yes	No	Sample	No	Sample
Europost 2	Gabriel ♥ ♻️ ♻️ ↓	Yes	No	Yes	Yes	Yes
Fame	Gabriel ♥ ♻️ ♻️ ↓	Yes	Yes	Yes	Yes	Yes
Fame Hybrid	Gabriel ♥ ♻️ ♻️ ↓	Yes	Yes	Yes	Yes	Yes
Harmony	Gabriel ♥ ♻️ ♻️ ↓	Yes	Yes	Yes	Yes	Yes
Hi-Tech	Camira ♥ ♻️ ♻️ ↓	No	No	Sample	Sample	Sample
Honeycomb	Camira ♥ ♻️ ♻️ ↓	Yes	No	No	No	No
Hemp	Camira ♥ ♻️ ♻️ ↓	Yes	Yes	Yes	Yes	Yes
Intervene Plain	Camira ♥ ♻️ ♻️ ↓	Yes	No	Yes	No	Yes
Intervene Texture	Camira ♥ ♻️ ♻️ ↓	Yes	No	Yes	No	Yes
Just	Gabriel ♥ ♻️ ♻️ ↓	Sample	Sample	Yes	Yes	Sample
Kyoto	Camira ♥ ♻️ ♻️ ↓	Square units	No	No	No	Yes
Landscape Balance	Camira ♥ ♻️ ♻️ ↓	Yes	Sample	Yes	Yes	Yes
Landscape Contact	Camira ♥ ♻️ ♻️ ↓	Yes	Sample	Yes	Yes	Yes
Medley	Gabriel ♥ ♻️ ♻️ ↓	Yes	Yes	Yes	Yes	Yes
Noma	Gabriel ♥ ♻️ ♻️ ↓	Yes	Yes	Yes	Yes	Yes
Oxygen (MOQ)	Camira ♥ ♻️ ♻️ ↓	Yes	Yes	Yes	Yes	Yes
Oceanic	Camira ♥ ♻️ ♻️ ↓	Yes	Sample	Yes	Yes	Sample
Passion	Gabriel ♥ ♻️ ♻️ ↓	Yes	Yes	Yes	Yes	Yes
Regent (MOQ)	Camira ♥ ♻️ ♻️ ↓	Yes	No	No	No	No

	Sustainability factor	Soft Seating/ RoomInRoom	Harc Tub High Back/FourLikes Meet 1400+700	Fully Upholstered FourCast/FourSure	FourMe	Seat & Inner Upholstered FourCast/FourSure
<b>Band 2 (cont)</b>						
Remix	Kvadrat  	Yes	Yes	Yes	Yes	Yes
Rhythm	Gabriel 	No	No	No	No	No
Runner	Gabriel   ↓	No	No	No	No	Yes
Select	Gabriel  	Yes	Yes	Yes	Yes	Yes
Savoy	Gabriel   ↓	Yes	No	No	No	No
Silk	Camira    ↓	Yes	Yes	Yes	Yes	Yes
Sumi	Camira  	Yes	Yes	Yes	Yes	Yes
Synergy	Camira   	Yes	Yes	Yes	Yes	Yes
Track	Camira   ↓	Yes	No	No	No	No
X2	Camira    ↓	Yes	Yes	Yes	Yes	Yes
Yoredale	Camira 	Yes	Yes	Yes	Yes	Yes
24/7 +	Camira	Sample	Sample	Yes	Yes	Sample
24/7 Flax	Camira  	Yes	Yes	Yes	Yes	Yes
<b>Band 3</b>						
Armadillo	Camira  	Yes	Yes	Yes	Yes	No
Atlantic	Gabriel  	Yes	Shade	Yes	Yes	Yes
Bond	Gabriel    ↓	Yes	Yes	Yes	Yes	Sample
Breeze & Breeze Fus.	Gabriel  	Yes	Yes	Yes	Yes	Yes
Hebden (MOQ)	Camira   	Yes	Yes	Yes	Yes	No
Illusion	Nevotex 	Yes	Sample	Yes	Yes	Yes
Individuo	Camira  	Yes	Yes	Yes	Yes	No
Mainline Flax Stripe	Camira   	Yes	Sample	Yes	Yes	No
Gaja Classic	Gabriel  	Yes	Yes	Yes	Yes	Yes
Rondo	Gabriel    ↓	Yes	Shade	Yes	Yes	Sample
Melange Nap	Kvadrat  	Yes	Shade	Yes	Yes	Shade
Re-wool	Kvadrat    ↓	Yes	Yes	Yes	Yes	Yes
Zap	Camira  	Yes	Yes	Yes	Yes	No
<b>Band 4</b>						
Capture	Gabriel  	Yes	Yes	Yes	Yes	Yes
Craggan Flax	Camira  	Yes	Harc Tub only	Yes	Yes	No
Divina Melange 2	Kvadrat   	Yes	Yes	Yes	Yes	Yes
Mood	Gabriel  	Yes	Harc Tub only	Sample	Sample	Sample
Nettle- Aztec	Camira  	Yes	Harc Tub only	Yes	Yes	No
Silvertex	Camira	Yes	Yes	Yes	Yes	Yes
<b>Band 5</b>						
Canvas 2	Kvadrat  	Yes	Shade	Shade	Shade	Shade
Criss Cross	Gabriel  	Yes	Sample	Yes	Yes	No
Fiord	Kvadrat  	Yes	Yes	Yes	Yes	Yes
Morph	Gabriel  	Sample	Sample	Sample	Sample	Sample
Revive 1	Kvadrat    ↓	Yes	Yes	Yes	Yes	Yes
Steelcut 2	Kvadrat  	Yes	Yes	Yes	Yes	Yes
Steelcut Trio 3	Kvadrat  	Yes	Yes	Yes	Yes	Yes
<b>Band 6</b>						
Hallingdal 65	Kvadrat  	Yes	Yes	Yes	Yes	Yes
<b>Band 7</b>						
Luna 2	Gabriel  	Yes	Yes	Yes	Yes	No
Revolution	Camira	Yes	Yes	Yes	Yes	Yes
Vintage L	Camira	Yes	Harc Tub only	Yes	No	Yes
Divina 3	Kvadrat   	Yes	Yes	Yes	Yes	Yes
<b>Band 8</b>						
Black leather		Yes	Yes	Yes	Yes	Yes
<b>Band 10</b>						
Leather, coloured		Yes	Yes	Yes	Yes	Yes

	<b>People Certification</b>	Certified for low VOC i.e. Oeko-tex, Greenguard Gold, Indoor Air Quality etc.
	<b>Planet Certification</b>	Certified for low environmental impact i.e. Ecolabel, Cradle-to-cradle etc.
	<b>Recycled materials</b>	Using either post-industrial or post-consumer recycled fibres. Using less energy and resources whilst resolving a potential waste issue.
	<b>100% Natural material</b>	Natural fibres like wool and hemp are naturally fire retardant and therefore may not need added FR chemicals (depending on requirements).
	<b>Less resource intensive</b>	Materials that use less water, energy or chemicals within production.

### § 1 Conclusion of Agreement

These general Terms of Sale and Delivery apply unless specifically derogated from by other written agreement.

### § 2 Prices and Payment – Retention of Title

All sales are made at prices in SEK applicable at the date of delivery. All prices are excl. VAT, public dues of any nature, packaging etc., unless otherwise specifically agreed and confirmed in writing by Vendor. Price stipulations in price charts are without obligation and may at any time be changed without prior notice. Current prices are listed in the newest updated price list. For goods not yet delivered, Vendor is entitled to increase the price equivalent to any price increase made by Vendor's subcontractors.

Payment is made cash with 30% before the production is started and the remaining 70% no later than 14 days before delivery, unless otherwise specifically agreed and confirmed in writing by Vendor.

Credit can be agreed if the Vendor can obtain satisfactory credit insurance from the Buyer. If the Vendor's insurance company revokes the credit insurance, the Vendor has the right to demand full payment immediately and without further notice.

On late payment default interest is charged with addition of interest at a rate of 2% per month started. If payment is not made on time the Vendor is entitled immediately and without further notice to cancel the sale.

The property right of the goods sold remains with Vendor in all respects until Buyer effectively has paid the purchase price and all other costs attached to the purchase.

### § 3 Time and Place of Delivery of Vendor's Goods

Times of delivery are approximate and not binding, unless otherwise specifically agreed and confirmed in writing by Vendor. Vendor cannot be held accountable for any costs due to delay.

All deliveries to the countries below\* are made 'CIP' (INCOTERMS 2020) to the Buyer's place of business or warehouse within normal working hours and via truck without a lift. However, only for bridged islands. Deliveries to all other countries and non-bridged islands are made 'EX WORKS' (INCOTERMS 2020).

Deliveries with a total order value of less than SEK 11.000 incur a shipping fee of SEK 1.600. Orders that only contain spare parts are exempt from shipping fees.

The risk of the goods purchased passes to Buyer on delivery. In cases where Buyer is committed to collect the goods and Vendor keeps them ready, the risk passes to Buyer already at that time.

For deliveries that deviate from the above, a shipping fee is calculated. This includes e.g. delivery directly to the end customer, delivery by lift, delivery by small truck, etc., as well as if there are special requirements for the time of delivery, e.g. delivery on a specific day of the week or within a specific period of the day.

*Contact (name, e-mail address and telephone number) and opening hours for receiving goods as well as any special requirements for trucks and delivery equipment.*

In the event of unsuccessful delivery due to missing or incorrect information from Buyer, the Vendor reserves the right to invoice the additional costs incurred.

\*The following countries are covered: Denmark, Norway (with zip code lower than 7995), Sweden, Finland, Germany, Benelux, France, Switzerland, Austria, Poland, Estonia, Latvia, and Lithuania.

### § 4 Delays by Vendor

If the Vendor becomes aware that he will be unable to meet the stipulated time of delivery, or that a delay on his part is likely to occur, he shall without undue delay notify the Buyer in writing stating the cause of the delay, and wherever possible, the time when delivery is likely to be made. Where a delay in delivery is due to any of the circumstances set forth in article 10 hereof (force majeure) or to acts or omissions on the part of the Buyer, the time of delivery shall be postponed for a period corresponding to the period in which the Vendor has been unable to deliver due to Buyer's conditions or conditions covered by article 10. This provision shall apply whether the cause of delay occurs before or after the end of the stipulated time of delivery. The Buyer shall not be entitled to cancel the agreement owing to delays in delivery attributable to the Vendor except where such delay exceeds three months.

The Buyer shall not be able to claim compensation owing to delays on the part of Vendor.

### § 5 Delays by Buyer

If the Buyer becomes aware that he will not be able to take delivery of/collect the goods by the stipulated date – or if a delay on his part is likely to occur – he shall forthwith notify the Vendor in writing, stating the cause of delay and, wherever possible, the time when taking delivery/collection of the goods shall be possible. In such cases the Buyer shall pay the purchase price and all other costs to the Vendor as if delivery of the relevant goods had taken place.

Should the Vendor not be able to deliver owing to conditions on the part of the Buyer, the Vendor shall make sure that the goods are properly stored for the Buyer's account and at the Buyer's risk. The Vendor shall at the Buyer's request insure the goods for the Buyer's account. The Vendor shall have the right to call upon the Buyer in writing to take delivery of the goods within a time limit of 15 days. Where the Buyer fails to do so within the same time limit for reasons that are not attributable to the Vendor, the Vendor shall be entitled to cancel the agreement by written notice to the Buyer. In such case, the Vendor shall have the right to demand compensation for any loss he has incurred from the Buyer's non-performance.

If the Buyer unjustifiably allows remediation to be carried out by a third party, the Buyer cannot demand his costs covered by the Vendor.

### § 6 Nonconformity

If it becomes apparent that the goods do not conform with the agreement, Vendor has the option to effect repairs or otherwise to redress. The Vendor is under no circumstances responsible for operating-, time-, profit-, or other indirect losses of the Buyer or the Buyer's customers or other users of the delivery. The Buyer cannot claim compensation to cover the costs that may be incurred during removal or reassembly.

Only if within a reasonable time and on a reasonable number of repair attempts Vendor is not able to correct or make good the defect etc., Buyer may arrange for repair by third party or claim a reduction in the purchase

price. If Buyer unjustly arranges for third party to repair, Buyer may not in such cases claim cover of his costs in respect thereof from Vendor.

In cases of short deliveries (quantitative lack of conformity) Vendor may make subsequent deliveries within a reasonable time, in which case Buyer may not invoke breach.

The Buyer shall notify the Vendor in writing of any defects without undue delay after such defects have appeared. Minor knots, differences in shades as well as strong and weak annual rings are signs of genuineness and are not considered to be defects.

Damage to products must be noted on the waybill for goods to be replaced. "Goods received with reservations" is not sufficient. Buyer carries the full risk that Vendor's goods are suited for purposes particularly applicable for Buyer.

If the Buyer has not notified the Vendor within two years from the date of delivery, the Buyer is prevented from making claims in respect of defects, compensation, any warranty claims, or other remedies.

#### § 7 Warranties

Vendor always uses first class materials, and our products continuously undergo strict quality control.

Information about testing and standards can be found on our website under the individual products: [www.fourdesign.dk](http://www.fourdesign.dk)

#### 5-year warranty

Vendor provides an extended warranty of 5 years on chairs and tables in our official price list. The warranty covers breakage of frames and damage occurred because of deficient craftsmanship performance under normal use.

The warranty shall lapse if the product shows signs of mishandling abuse or other physical damage. The warranty does not cover those parts of the product which are exposed to abrasion during use.

#### Spare parts

Spare parts for the furniture product will be available for a period of 5 years from the date of purchase of the product.

The parts will be available without charge during the guarantee period if the goods are found to be faulty during normal use.

A proportionate cost will be charged if the goods were damaged by misuse.

#### Surfaces

Vendor recommends the use of chrome on stacking chairs and foldable tables. There is no warranty for damage to other surfaces such as Satin chrome and powder coating.

Vendor do not recommend black lacquered veneer on seats or powder painted steel where the chair suspension system is being used.

When stacking upholstered chairs, you may get pressure marks on the fabric. These are temporary and will disappear once the chairs are unstacked.

We rely on the fabric supplier's guarantee, as far as wear, peeling, etc.

#### § 8 Limitation of Liability

Vendor is only liable for defects in Vendor's goods if Buyer has used the goods as prescribed and in a sound manner, and according to Vendor's directions, if any. Vendor's liability is limited to defects in Vendor's own goods and not to defects or faults that arise in connection with Vendors.

goods being incorporated in or to those of others. In no circumstances is Vendor liable for any loss on operations, time, profit margin or other indirect losses suffered by Buyer or Buyer's customers or other users of Vendor's goods. Buyer may not claim compensation to cover the costs incidental to dismounting and remounting the objects or installations, in which the goods might be incorporated.

To the extent that Vendor is held liable towards third parties, Buyer must hold Vendor harmless to the extent such liability exceeds the limits set out in these terms. In no event may Vendor's liability for the goods supplied exceed the total price hereof.

#### § 9 Product Liability

In the mutual relations between Vendor and Buyer, Vendor excludes any liability for commercial property damage that may be attached to Vendor's goods. If Vendor is met with claims for damages for commercial property damage from Buyer's customers, their customers or other later users of Vendor's goods, Buyer in the relations between Vendor and Buyer is committed to indemnify Vendor for any such claim and to cover Vendor's reasonable costs to any defence against that.



**§ 10 Force majeure**

The following circumstances shall give rise to exemption from liability if they prevent the performance of the agreement or render such performance unreasonably onerous: Labour conflicts and any other circumstance beyond the control of the Vendor, such as but not limited to fire, war, mobilisation or unforeseen military callups of a corresponding scale, requisitioning, seizure, foreign exchange restrictions, insurrection and civil unrest, lack of transportation, general scarcity of goods, and defects in or delays of deliveries from sub suppliers due to any of the factors set forth in this paragraph.

Circumstances of the type mentioned above, which had occurred prior to the conclusion of this agreement, shall exempt the Vendor from liability only where their influence on the performance of the agreement could not be foreseen by the Vendor at the time when the agreement was entered into. Where the Vendor intends to invoke any exemption from liability grounds set forth in this article, he shall without undue delay notify the Buyer in writing of such grounds.

Notwithstanding any stipulation in these conditions of sale and terms of delivery, either of the parties may cancel the agreement by written notice to the other party where the performance of the agreement is prevented for more than six months by one of the events set forth in this article.

**§ 11 In general**

Any disputes arising out of or in connection with agreements between Vendor and Buyer are to be settled pursuant to Danish law.

Vendor reserves the right for printing errors. Vendor's liability for the goods supplied exceed the total price hereof.

**Last update: January 2024**



## You are Always Welcome in our Showrooms

**Aarhus**  
+45 4016 6565  
Balticagade 15  
DK-8000 Aarhus C  
**Denmark**

**Copenhagen**  
+45 2030 7122  
Carl Jacobsensvej 16  
DK-2500 Valby  
**Denmark**

**Odense**  
+45 6229 1132  
Lucernemarken 17-19  
DK-5260 Odense S.  
**Denmark**

**Oslo**  
+47 9953 0223  
Drammensveien 130  
0277 Oslo  
**Norway**

**Düsseldorf**  
+49 1722 8042 42  
Düsseldorfer Str 16  
DE-40699 Erkrath  
**Germany**

**London**  
20 Old Street  
Clerkenwell  
London, EC1V 9AB  
**United Kingdom**

**Northampton**  
Caswell Road  
Brackmills Industrial Est.  
Northampton, NN4 7PW  
**United Kingdom**

---

## Ocee & Four Design products are available worldwide

North America  
[hightoweraccess.com](http://hightoweraccess.com)

**Hightower**

Oceania  
[fusefurniture.com.au](http://fusefurniture.com.au)



China  
[Novah.cn](http://Novah.cn)







We turn good  
spaces into great  
experiences

[OCEEFOUR.COM](http://OCEEFOUR.COM)