

Revo Price List

Valid from the 1st of January 2023
edition 2

All prices: SEK

Products	
Revo	8
Revo Table	24
Technical details	30
Additional information	
Glides, table tops and joining in rows	34
Consumption of fabric	35
Measuring methodology	36
Terms of guarantee	38
Fabrics and finishings	40
Fabrics - Curated and Extended	44
Legend	48

When placing your order please remember to specify the following information:

- All configuration details of products
- Required delivery/dispatch date
- Required delivery address

Binding sales agreement for the ordered products is concluded by formal order confirmation sent by Flokk.

Flokk sales conditions override any individual customer's general terms & conditions or regulations.

PRICES

All prices in SEK accordingly exclusive of VAT. Valid from 01/11/2022 Any typographical errors shall not be binding for Flokk and will be subject to correction without liability to the vendor.

CONDITIONS OF DELIVERY

Ex Works (Incoterms 2020), including packaging. Visible transport damage and discrepancies in the number of items received must always be noted on the bill of carriage at the time of receipt and reported to the carrier. Invisible transport damage (damaged product, but not package) should be reported in writing to Customer Service or Claim Department, Flokk AB within 7 days.

In case of delays in ready products collection storage fees will apply, details available at Customer Service.

CHANGE/CANCELLATION OF ORDERS

Any requests for change or cancellation of the order must be submitted within 2 working days after the receipt of the order confirmation.

After this time each amended or cancelled order will incur a charge of SEK 500 per order. Once production has started orders cannot be changed.

TRANSPORTATION & ENERGY SURCHARGE

A 3% transportation & energy surcharge on the net order value will be applied to all orders with delivery terms agreed different from Ex Works/FCA Turek.

DISCLAIM

Flokk disclaims any responsibility for products that are configured or assembled in a different way than Flokk's official configurations. That is, as a result of component purchases, special orders or the like.

	Sofas, armchairs, modular systems	Pouffes	Tables
Revo	•	•	
Revo Tables			•

Sofas

Modular systems

Revo



P40

Pouffe,
Ø 40 cm

P60

Pouffe,
Ø 60 cm

Price Group 1

Cura, Xtreme

5056

6122

Price Group 2

Select

5567

6878

Price Group 3

Oceanic

5845

7222

Price Group 4

Steelcut 3, Steelcut Trio 3

6079

7511

Price Group 5

7112

8787

The above fabrics are Standard fabrics & colours.

See last pages of this price list for complete list of Standard, Curated and Extended fabrics & colours and related price groups.



www.blauer-engel.de/uz117

Legend: ● Standard - Not applicable

	P40	P60
Glides		
Teflon glides - universal (set)	●	●
Other		
Mediaport - electrical outlet 230V and 1 USB ports	-	2322

Additional information

Individual modules allow to create various types of systems / sets depending on your needs. A full list of possible configurations is available through the Configurator Guide.

The price for a configured set is the amount of the value of each module of a given set.

Possibility to freely choose the type of upholstery for individual elements within a given set (e.g. seat: Select, backrest: Steelcut Trio 3, screen: Cura).

There is no possibility to connect the pouffes permanently to a set.

See last pages of this price list for complete list of Standard, Curated and Extended fabrics & colours and related price groups.



SN150

Seat narrow,
length 150 cm



SN210

Seat narrow,
length 210 cm

Price Group 1 Cura, Xtreme	11900	15233
Price Group 2 Select	12767	16389
Price Group 3 Oceanic	13405	17208
Price Group 4 Steelcut 3, Steelcut Trio 3	13941	17897
Price Group 5	16311	20939

The above fabrics are Standard fabrics & colours.

See last pages of this price list for complete list of Standard, Curated and Extended fabrics & colours and related price groups.

Legend: ● Standard

SN150 **SN210**

Glides

Teflon glides - universal (set)	●	●
---------------------------------	---	---

Other

Mediaport - electrical outlet 230V and 1 USB ports	2322	2322
--	------	------

Additional information

Individual modules allow to create various types of systems / sets depending on your needs. A full list of possible configurations is available through the Configurator Guide.

The price for a configured set is the amount of the value of each module of a given set.

Possibility to freely choose the type of upholstery for individual elements within a given set (e.g. seat: Select, backrest: Steelcut Trio 3, screen: Cura).

See last pages of this price list for complete list of Standard, Curated and Extended fabrics & colours and related price groups.



SW120

Seat wide,
length 120 cm



SW180

Seat wide,
length 180 cm



SW240

Seat wide,
length 240 cm

Price Group 1 Cura, Xtreme	12600	16778	20822
Price Group 2 Select	13444	17889	22200
Price Group 3 Oceanic	14117	18783	23310
Price Group 4 Steelcut 3, Steelcut Trio 3	14681	19535	24242
Price Group 5	17177	22856	28364

The above fabrics are Standard fabrics & colours.

See last pages of this price list for complete list of Standard, Curated and Extended fabrics & colours and related price groups.

Legend: ● Standard

	SW120	SW180	SW240
Glides			
Teflon glides - universal (set)	●	●	●
Other			
Mediaport - electrical outlet 230V and 1 USB ports	2322	2322	2322

Additional information

Individual modules allow to create various types of systems / sets depending on your needs. A full list of possible configurations is available through the Configurator Guide.

The price for a configured set is the amount of the value of each module of a given set.

Possibility to freely choose the type of upholstery for individual elements within a given set (e.g. seat: Select, backrest: Steelcut Trio 3, screen: Cura).

See last pages of this price list for complete list of Standard, Curated and Extended fabrics & colours and related price groups.



B90

Backrest,
length 90 cm



B120

Backrest,
length 120 cm

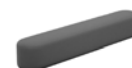

B180

Backrest,
length 180 cm

Price Group 1

Cura, Xtreme

4533

5422

7700

Price Group 2

Select

4944

5922

8433

Price Group 3

Oceanic

5192

6218

8855

Price Group 4

Steelcut 3, Steelcut Trio 3

5399

6467

9209

Price Group 5

6317

7566

10775

The above fabrics are Standard fabrics & colours.

See last pages of this price list for complete list of Standard, Curated and Extended fabrics & colours and related price groups.



Additional information

Individual modules allow to create various types of systems / sets depending on your needs. A full list of possible configurations is available through the Configurator Guide.

The price for a configured set is the amount of the value of each module of a given set.

Possibility to freely choose the type of upholstery for individual elements within a given set (e.g. seat: Select, backrest: Steelcut Trio 3, screen: Cura).

See last pages of this price list for complete list of Standard, Curated and Extended fabrics & colours and related price groups.



W90

Screen,
wide 90 cm



W120

Screen,
wide 120 cm



W180

Screen,
wide 180 cm

Price Group 1 Cura, Xtreme	6533	8289	11089
Price Group 2 Select	7478	9544	13011
Price Group 3 Oceanic	7852	10022	13607
Price Group 4 Steelcut 3, Steelcut Trio 3	8166	10423	14199
Price Group 5	9554	12194	16566

The above fabrics are Standard fabrics & colours.

See last pages of this price list for complete list of Standard, Curated and Extended fabrics & colours and related price groups.

Additional information

Individual modules allow to create various types of systems / sets depending on your needs. A full list of possible configurations is available through the Configurator Guide.

The price for a configured set is the amount of the value of each module of a given set.

Possibility to freely choose the type of upholstery for individual elements within a given set (e.g. seat: Select, backrest: Steelcut Trio 3, screen: Cura).

The screens can only be combined with wide seats: SW120, SW160 or SW240.

It is not possible to purchase the screen as a free-standing module.

See last pages of this price list for complete list of Standard, Curated and Extended fabrics & colours and related price groups.

Sample configurations

Sample configurations

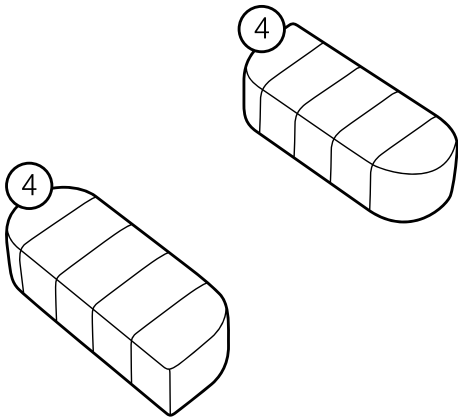

Dimensions:
two sofas 150 x 85 cm

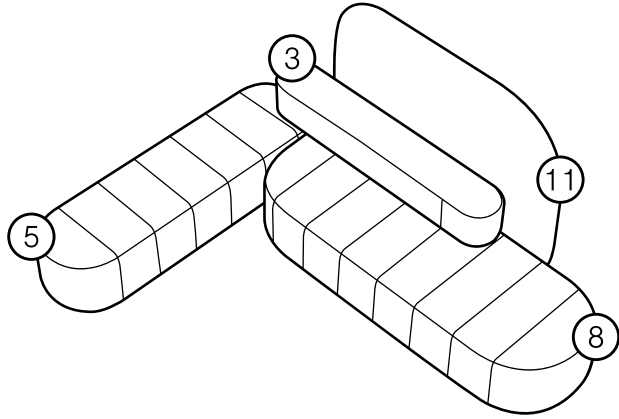

Dimensions:
212 x 300 cm

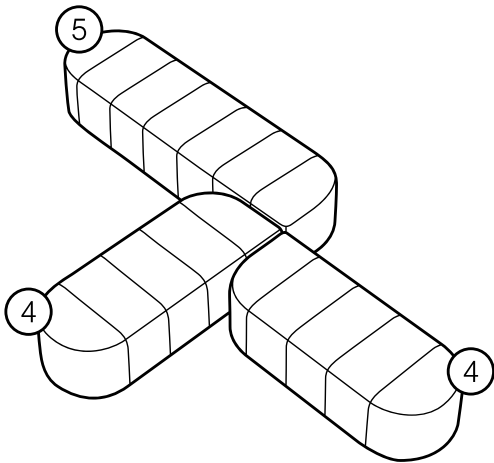

Dimensions:
360 x 210 cm

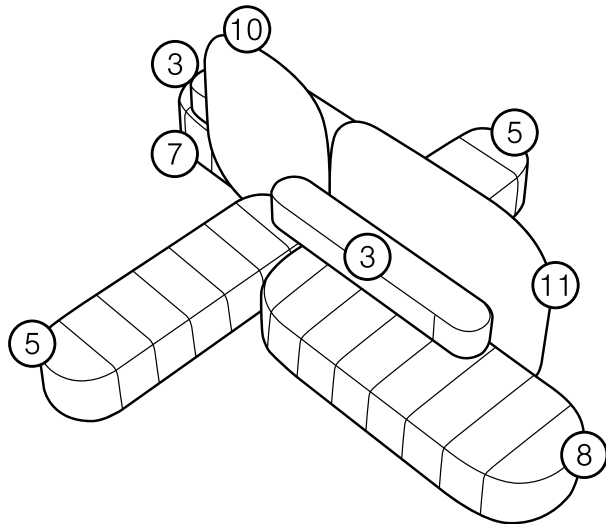

Dimensions:
362 x 420 cm

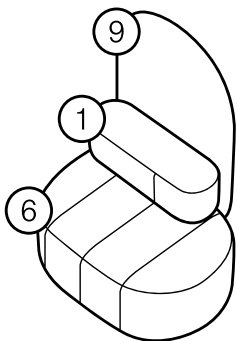

Dimensions:
120 x 87 cm

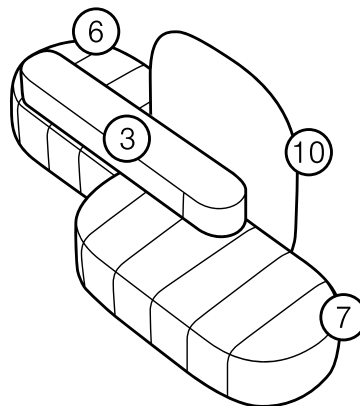

Dimensions:
300 x 140 cm

- | | | | | |
|--------|---------|---------|--------|-------|
| ① B90 | ④ SN150 | ⑦ SW180 | ⑩ W120 | ⑬ P60 |
| ② B120 | ⑤ SN210 | ⑧ SW240 | ⑪ W180 | |
| ③ B180 | ⑥ SW120 | ⑨ W90 | ⑫ P40 | |

Individual modules allow to create various types of systems / sets depending on your needs. A full list of possible configurations is available through the Configurator Guide.

Tables

Revo Tables



T180

Table,
1800 x 850 mm,
height 740 mm,
rectangular,
flat base



T150

Table,
1500 x 750 mm,
height 740 mm,
rectangular,
flat base



T75

Table,
750 x 750 mm,
height 740 mm,
square,
flat base

Natural veneers

Ash (NA), Beech (NB), Oak (NO), Walnut (NW)

15778

13711

7322

Natural coloured veneers (ash)

White (CNA01), Black (CNA02), Dark green (CNA05), Navy blue (CNA06), Burgundy (CNA07)

15778

13711

7322

HPL

White (LW01), Black (LW02), Navy Blue (LW06), Light Burgundy (LW07)

17200

14344

7789

Legend: ● Standard ○ Option

	T180	T150	T75
Frame			
Black RAL 9005	○	○	○
MetallicPro	○	○	○
White RAL 9016	○	○	○
Deep green RAL 6004	○	○	○
Navy blue RAL 5003	○	○	○
Burgundy RAL 3005	○	○	○
Salvia/Green RAL 6021	○	○	○
Blue RAL 5014	○	○	○
Terracota RAL 3012	○	○	○
Glides			
Felt glides (for hard floors)	●	●	●

Additional information

Any combination of table top and frame colours is possible.

Natural veneers: Ash (NA); Beech (NB); Oak (NO); Walnut (NW) - delivery time 30 working days.

Natural coloured veneers: delivery time 30 working days.

HPL table tops: delivery time 30 working days.

Revo Tables

Pearson Lloyd Design

profim



LS65

Table,
650 x 350 mm,
height 665 mm,
rectangular,
flat base



LR48

Table,
round Ø 480 mm,
height 665 mm,
round base,
flat



C150

Low table,
1500 x 750 mm,
height 450 mm,
rectangular,
flat base



C75

Low table,
750 x 750 mm,
height 450 mm,
square,
flat base

Natural veneers

Ash (NA), Beech (NB), Oak (NO), Walnut (NW)

4922

4922

13233

7089

Natural coloured veneers (ash)

White (CNA01), Black (CNA02), Dark green (CNA05), Navy blue (CNA06), Burgundy (CNA07)

4922

4922

13233

7089

HPL

White (LW01), Black (LW02), Navy Blue (LW06), Light Burgundy (LW07)

5222

5222

13878

7567

Legend: ● Standard ○ Option

	LS65	LR48	C150	C75
Frame				
Black RAL 9005	○	○	○	○
MetallicPro	○	○	○	○
White RAL 9016	○	○	○	○
Deep green RAL 6004	○	○	○	○
Navy blue RAL 5003	○	○	○	○
Burgundy RAL 3005	○	○	○	○
Salvia/Green RAL 6021	○	○	○	○
Blue RAL 5014	○	○	○	○
Terracota RAL 3012	○	○	○	○
Glides				
Felt glides (for hard floors)	●	●	●	●

Additional information

Any combination of table top and frame colours is possible.

Natural veneers: Ash (NA); Beech (NB); Oak (NO); Walnut (NW) - delivery time 30 working days.

Natural coloured veneers: delivery time 30 working days.

HPL table tops: delivery time 30 working days.

Technical details

Revo

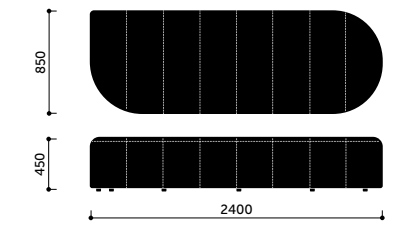

SW240

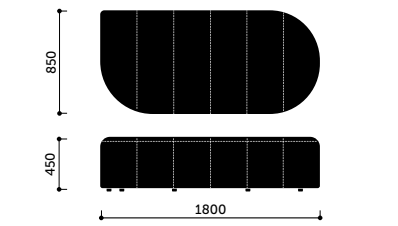

SW180

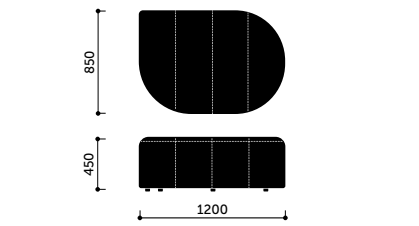

SW120

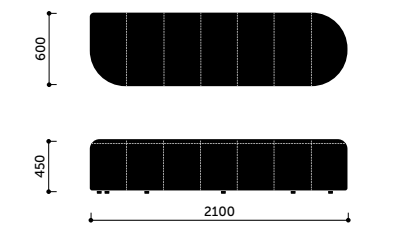
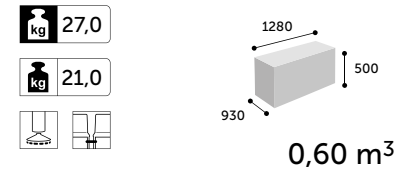
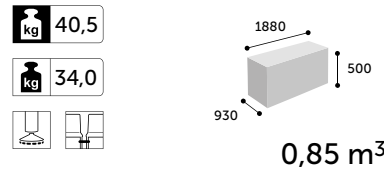
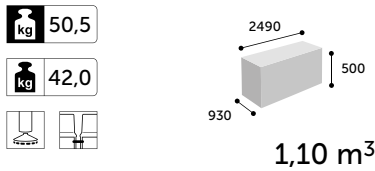

SN210

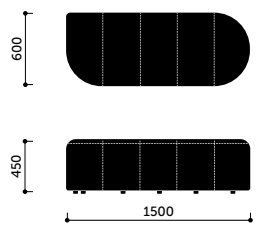

SN150

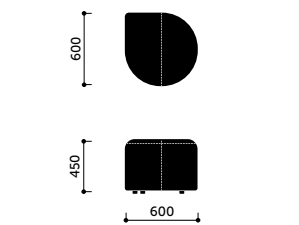

P60

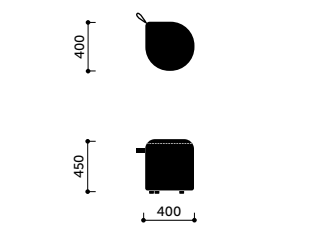

P40

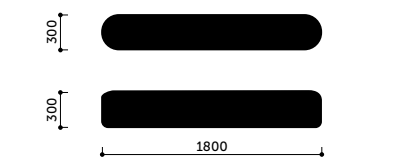
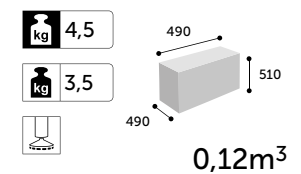
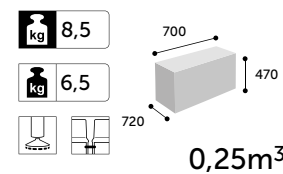
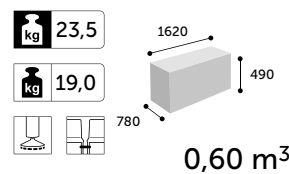
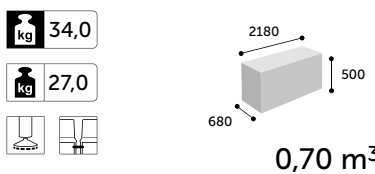

B180

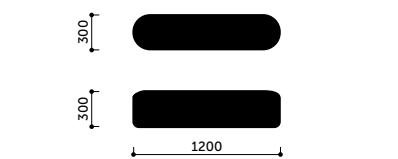

B120

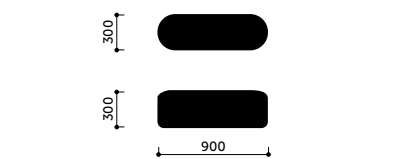

B90

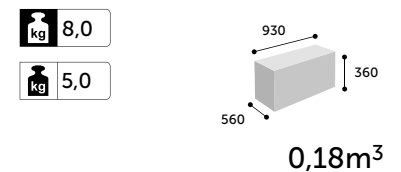
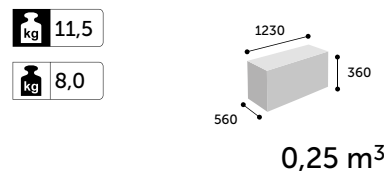
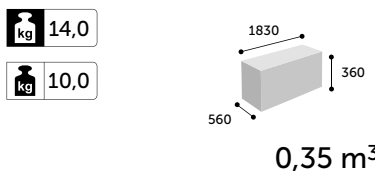

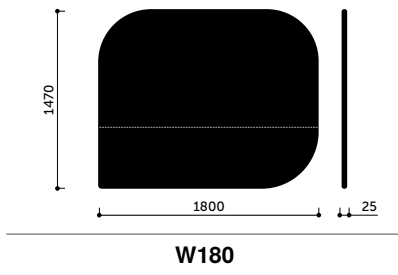

kg 23,0
kg 20,0

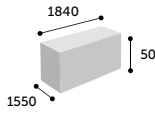

0,13 m³

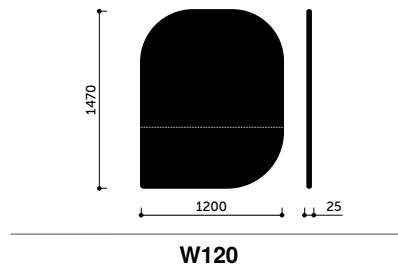

kg 16,5
kg 12,5

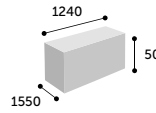

0,09m³

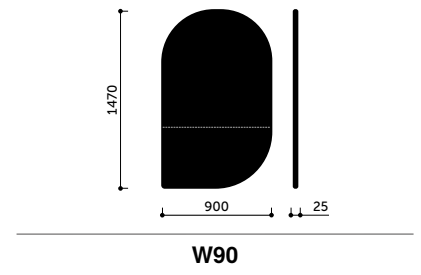

kg 10,0
kg 8,5

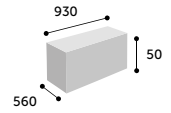

0,03 m³

Revo Tables

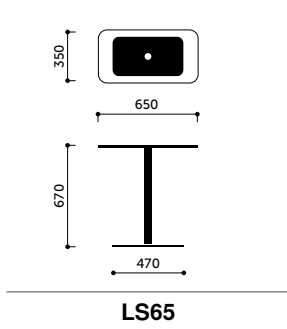

kg 12,6
kg 10,6

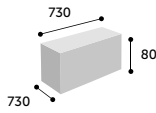

0,04 m³

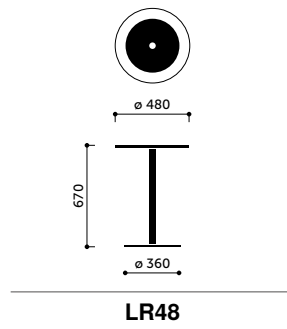

kg 11,1
kg 9,1

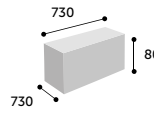

0,04 m³

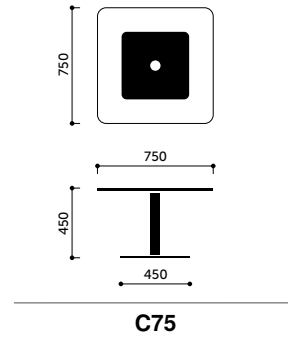

kg 21,8
kg 18,9

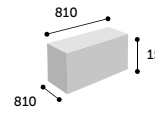

0,10 m³

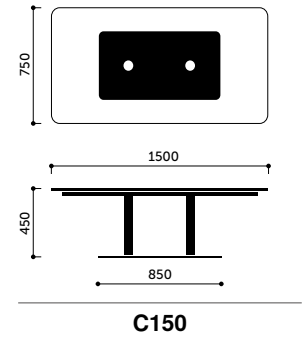

kg 45,5
kg 37,0

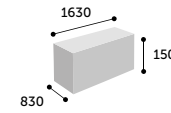

0,20 m³

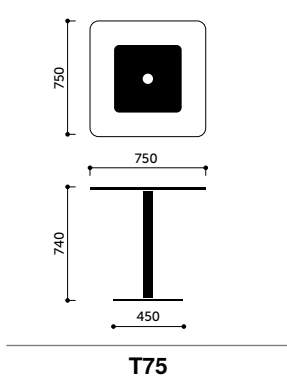

kg 22,9
kg 20,0

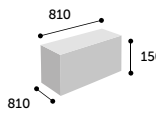

0,10 m³

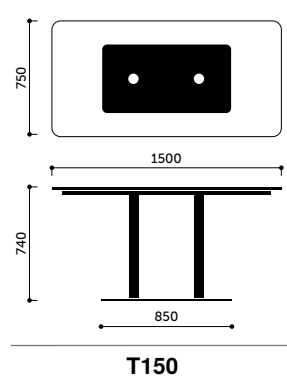

kg 49,0
kg 40,5

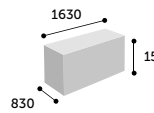

0,20 m³

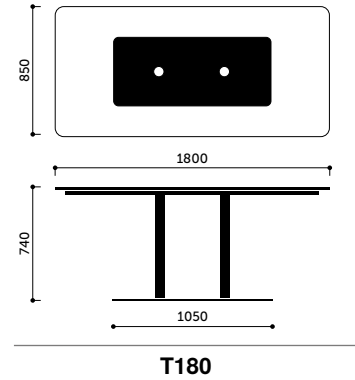

kg 59,3
kg 46,8

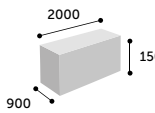

0,27 m³

Additional information

Glides, table tops, joining in rows

Consumption of fabric

Measuring methodology

Terms of guarantee

Fabrics and finishings

Legend

Alphabetical index

Glides, table tops, joining in rows

profim

Felt glides
(for hard surfaces)

Teflon glides
(universal)

Revo



Revo Tables



The quantities below are only estimated. The real quantity of fabric consumption may vary in accordance to the quantity of pieces on order. Please notice that before we accept any order in customer's own material we need to make sample trials. Please be aware that not every type of fabric is suitable for upholstery. Volume of customer's own material must be agreed each time with Profim sales organisation

Column A - Estimated consumption of fabric (roll width: 1,40 m)

	A
Revo	
P40	1,5
P60	2,2
SW120	2,4
SW180	3,2
SW240	3,9
SN150	2,6
SN210	3,3
B90	1,2
B120	1,5
B180	2,1
W90	2,9
W120	3,8
W180	5,6

Swivel armchairs and chairs are measured with a mechanism adjusted in such a way that the seat is as level as possible, while the backrest remains vertical. Swivel armchairs and chairs are measured on their castors, whereas visitor and reception chairs on hard glides. The measurements are approximate and can differ depending on the product configuration.

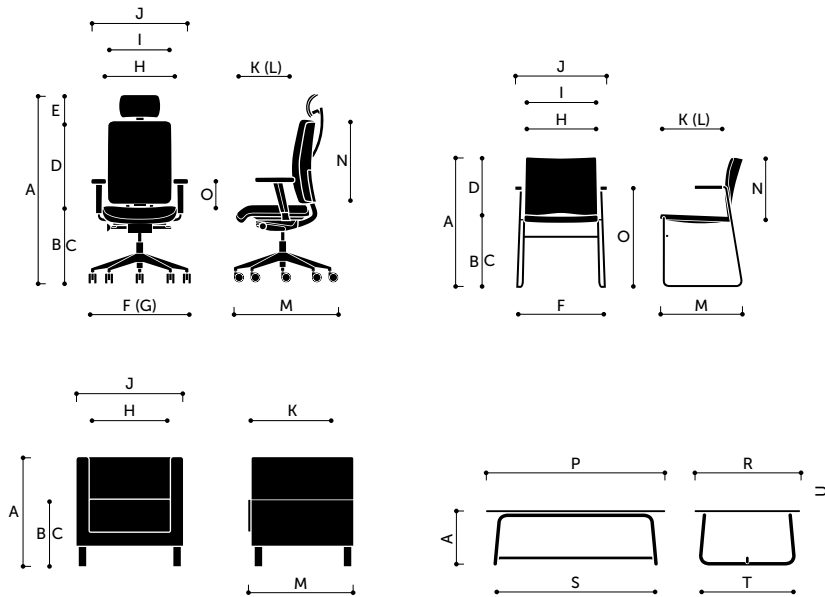

A - Total height

For products fitted with a gas lift - it is measured with gas lift's minimum and maximum extension. For products fitted with an additional backrest and headrest height adjustment - it is measured in both minimum and maximum positions of the backrest, headrest and gas lift.

B - Seat height

Measured at the highest point of the seat. For products fitted with a gas lift - it is measured with absorber's minimum and maximum extension.

C - Seat height with the burden

Seat measured according to EN standards (with seat burden). For products fitted with a gas lift - it is measured with gas lift's minimum and maximum extension.

D - Backrest height

Measured from the seat to the backrest upper edge. For products with adjustable backrest height - it is measured in the minimum and maximum position.

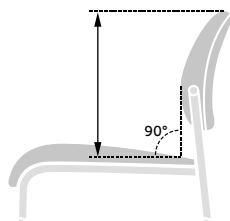

E - Headrest height

Measured from the backrest upper edge to the headrest upper edge. The headrest adjusted in maximum vertical position in relation to the upper and lower edge of the headrest. Measured in the headrest's minimum and maximum position.

F - Base, frame width

Measured at the uttermost points of the base according to the following figures.

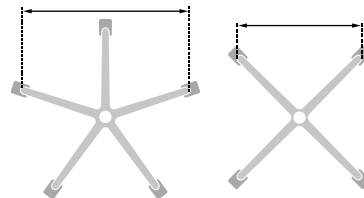

G - Base diameter

Measured according to the figure underneath.

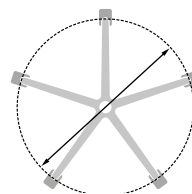

H - Seat width

Measured at the uttermost points of the seat.

I - Backrest width

Measured at the uttermost points of the backrest.

J - Total width

Measured at the uttermost points. For products fitted with adjustable armrests - it is measured with the armrests slid apart to maximum. For products fitted with armrests with adjustable pads - it is measured with the pads slid apart to maximum.

K - Seat depth

Measuring the distance between the uttermost point on the seat and the point it touches the backrest (the contact point is determined with a level positioned vertically to the backrest by projecting the S point from the backrest onto the seat) (1). For some shell chairs, where there is no distinct border-line between the seat and the backrest, the depth is measured on the bend halfway between the seat and the backrest (2). For products with additional adjustable seat depth - it is measured with minimum and maximum slide.

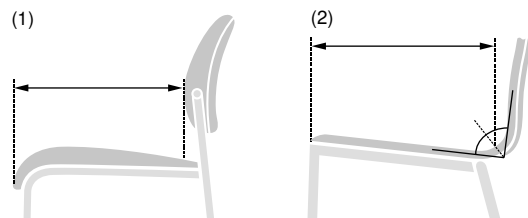

U - Table top thickness

Table top (element) thickness is measured.

L - Seat (element) length

Measured at the uttermost points of the seat.

M - Total depth

Measured at the uttermost points. Swivel armchairs and chairs are measured according to the drawing underneath. For products with adjustable seat depth - it is measured with minimum and maximum slide.

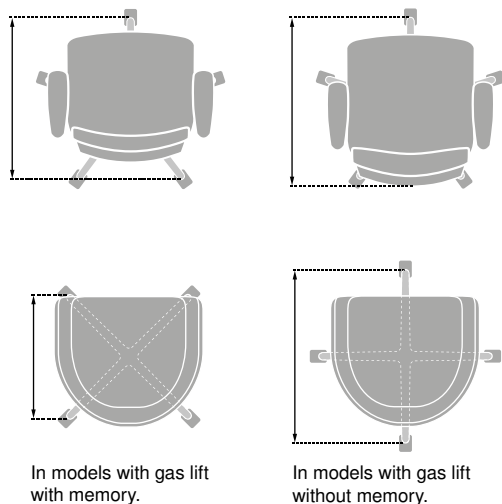

N - Backrest (element) length

Measured at the uttermost points of the backrest.

O - Armrest height

For swivel armchairs and chairs – it is measured from the seat surface to the armrest upper edge. For armrests with adjustable height – it is measured in the minimum and maximum position. For visitor chairs – it is measured from the floor to the armrest upper edge.

P - Table top length

Measured at the uttermost points of the table top.

R - Table top width

Measured at the uttermost points of the table top.

S - Table frame length

Measured at the uttermost points of the table frame.

T - Table frame width

Measured at the uttermost points of the table frame.

Terms of guarantee

applies to products manufactured after January 15th, 2019

1. Profim (the Guarantor) guarantees the efficient operation of its products.
2. Claims must be submitted at the purchase location, on a claims form (which can be downloaded from www.profim.eu), together with a purchase document (invoice or guarantee) and the guarantee certificate, if the certificate in question was issued to the Purchaser.
3. Claimed products will be accepted only if cleaned, packaged, and secured against damage in shipping.
4. The claimed product should be delivered, along with the documents listed in point 2, to the purchase location. If the claim is rejected, the product is sent back to the purchase location at the cost of the Purchaser.
5. The Guarantor shall determine whether the claim is justified within 14 days from the claimed products' delivery to manufacturer (together with claim application). A claims department employee will contact the Purchaser by phone or e-mail in order to determine the date and manner of product repair/replacement. Any doubts related to the claims procedure may be clarified at the phone number + 48 63 289 88 40 from Monday to Friday, 9-15, or at the e-mail address export@profim.pl. Submitting a claim does not entitle the Purchaser to withhold payment for the product.
6. In order to enable the manufacturer to identify the product, the claim notice should include information from the product's LABEL, i.e. the date of manufacture, order number, product number, and configuration. Any tampering with the LABEL will cause the guarantee to become null and void.
7. Guarantee period.
Refers to the products listed in the current price list and on the website www.profim.eu.

Guarantee period	Offer	Operating mode
5 years not longer however than 7 years from production date	Standard Classic - selected products	5 days a week, 8 hours per day (single shift work)
3 years not longer however than 4 years from production date	Classic	5 days a week, 8 hours per day (single shift work)

8. If the product is used for more than 8 hours per day, the guarantee period is reduced to three years.
9. Chair parts (e.g. castors, mechanisms, plastic parts) sold to the Purchaser are covered by a 2 years warranty.
10. If the product is replaced with another product free of defects or repaired by having one of its parts replaced, the course of the guarantee for such product or element is restarted. The guarantee period is extended by the period in which the Purchaser could not make use of the product.
11. If a defect cannot be removed or the removal involves excessive costs, the Guarantor may replace the product with another product free of defects. Any replaced defective products or parts thereof become the property of the Guarantor.
12. In case where an identical product is not available, the Guarantor may replace it with another product free of defects and with identical/similar parameters.

13. Claims concerning mechanical damage (scratches, dents, abrasions, upholstery soiling, missing parts etc.) will be accepted only if submitted within 7 days from the date of handing the product over to the Purchaser. By the above deadline, the Purchaser should unpack the product and remove the wrapping and protective elements in order to rule out mechanical damage. If reservations are made upon delivery with respect to the delivered product, a damage protocol must be drawn up in the presence of the courier or carrier and sent to the Guarantor together with the claims notice.
14. The refusal to hand the product (or any part thereof) over for repair in factory conditions, or preventing repair at the site of the Purchaser, causes the Guarantor to be released from its guarantee obligations and any guarantee claims to be waived.
15. The date of product repair at the site of the Purchaser is scheduled by the Guarantor.
16. Customized products i.e. chairs covered with fabric provided by the Purchaser and manufactured using technology that is not standard for a given product (such as using another base, armrests, covered by a fabric that is not part of standard offer etc.) are covered by one year guarantee.
17. The guarantee covers solely products located on the territory of the Republic of Poland or the country of the Distributor.
18. The Guarantor reserves the right to make innovations in the products that do not alter their durability and usability.
19. Repairs conducted by unauthorized persons or using unauthorized parts will cause the guarantee to become null and void.
20. The Purchaser's rights hereunder do not include the right to pursue lost profits and be indemnified for any potential damage caused by product failure.
21. The Guarantor's liability covers solely defects inherent in the product sold.
22. If the product is damaged after the expiry of the guarantee, the Guarantor may send, if possible, the Purchaser the required element or cure the defect using its factory service. In both cases the Purchaser will be charged accordingly.

THE GUARANTEE DOES NOT COVER:

- a) defects caused by assembling the product in a manner not compliant with the manual and using it in a manner not compliant with its purpose,
- b) damage caused during transport and transloading (does not apply to transport provided by the Guarantor),
- c) failure to observe the recommendations contained in the user's manual, damage to castors, glides or floor caused by the inappropriate choice of available options (e.g. using hard castors on hard surfaces); the proper choice of options does not rule out damages that may be caused by using the chairs on carpets, panels, parquet floors etc. of inappropriate quality or on soiled surfaces (e.g. by sand),
- d) damage resulting from extreme climate conditions or environmental factors (e.g. acids, humidity etc.),
- e) damage caused by departing from standard specifications at the customer's request,
- f) operational wear and tear of wheels or upholstery materials,
- g) wear and tear of felt glides, which can be replaced under warranty, only in case the felt come away,
- h) differences in the fabrics shade, if the products come from different manufacturing series of the fabric manufacturer, and differences in individual products purchased by the Purchaser successively are claimed,
- i) discoloration of upholstery caused by some of the clothing colourants and additional colourants (such as those used in denim) which may transfer onto lighter upholstery (the effect can be intensified due to humidity and temperature and is irreversible),
- j) soiling and permanent discolouring of upholstery caused by external factors,
- k) leather upholstery products, where the natural features of the material, such as smell, difference in the structure, texture and shade differences, scars and insects pricks are claimed; during use (e.g. on the seat) the leather takes on shine and becomes looser; the Guarantor does not accept claims motivated by the above features,
- l) foam deformations,
- m) differences in the hardness of polyurethane cold-moulded foam resulting from parameter variations, which according to the DIN 53576/ISO 2439 norm are acceptable if within the range of +/- 10%,
- n) damaging the surface of wooden elements as a result of contact with the edges of desks or other office furniture; mechanical damage of wooden surfaces is not considered to be a product defect,
- o) wooden components used in products, if the slight differences occurring in individual elements are claimed; the character of the raw material makes it impossible to precisely determine the final aesthetic effects, defined by the wood colour, shade, and figure,
- p) differences in geometry of plywood shells, which, because of their natural properties, may differ in tolerance of +/- 1.5 degrees,
- r) small variations in HPL colours, in accordance with PN-EN 438 norm.
- s) differences in colour, gloss, tone or pattern in ceramic table tops. It is natural material and above features are characteristic of this type of surface.

GENERAL REMARKS CONCERNING PRODUCT USE:

- 23. The products should be protected against the direct influence of sunrays.
- 24. Leather products should not be placed next to a heater or another heat source. Please observe a minimum distance of 30 cm from the heat source.
- 25. Leather should be maintained using special care products that create a protective layer resistant to water and oil substances.
- 26. Products should be protected against becoming wet.
- 27. The upholstery fabric should be protected against soiling by grease, sweat, lubricants etc. In case of soiling, apply appropriate cleaning agents.
- 28. Avoid exposing upholstery to extensive, focused tension (for example standing on a chair) that can result in splitting or a rip of stitching as well as mechanical damage to upholstery.
- 29. Upholstered furniture is supposed to be used to sit evenly on the seat surface to avoid natural tendency of fabrics and leather to creasing and wrinkling due to ongoing pressure, temperature and the moist of the body (wrinkling and creasing is not a product fault but a natural effect; the bigger the upholstered surface the higher tendency for this effect to occur).
- 30. Products should be dusted at least once a week.
- 31. Hard castors are used with soft carpeting and carpets.
- 32. Soft castors are used with hard floors (e.g. PVC, parquet floors, floor panels).
- 33. Remarks concerning the use of products containing plywood elements:
 - temperature range from +15°C to +30°C,
 - humidity range from 40% to 65%.
- 34. Ceramic tops meet the frost resistance requirements per EN 10545-12.
- 35. Table Chic RH and RR with metal and ceramic table top (apply only when frame/column is made of EPO1, EPO2, EPO3, with hard or teflon glides) can be for outdoor use according to EN 12944-2 cat. C3.
- 36. Plastic elements of the products like bases, armrests cover (especially light grey colours) require regular cleaning adequate to density of usage.

Fabrics and finishings

This is the standard selection of textiles and colours for Revo. All fabrics in our Standard collection are of excellent quality and come from renowned suppliers we choose to collaborate with. Normal delivery time for Standard fabric collection is 10-20 working days from factory. The guarantee requires that routine cleaning is performed on the chair and textile.

Maintenance: Please vacuum with a furniture brush or use a clean, white cloth or sponge slightly dampened with clean, lukewarm water.

Please note that colours shown in these illustrations may vary from the actual colours.

Please contact your local Profim supplier to view a sample.

Cura (Gabriel)

Price group 1

Cura is a two-coloured fabric made from 98% post-consumer recycled polyester. It has a matt, slightly irregular and natural-looking texture where the dark, underlying grey fibers create a discreet yet vibrant melange effect. High durability and stretchability and its soft, voluminous touch make Cura suitable for both office and lounge furniture.

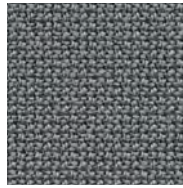

CU60110

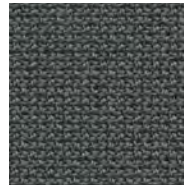

CU60109

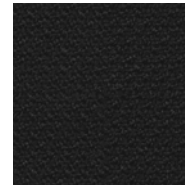

CU60999



CU66165

Composition: 98% post-consumer recycled polyester, 2% polyester.

Abrasion resistance: 100 000 Martindale (EN ISO 12947-2)

Flammability: BS EN 1021: 1-2, BS 5852 0&1, CA TB 117-2013, ASTM E 84 Class I.

Light fastness: 5-8 (EN ISO 105 - B02)

Rubbing fastness: 4-5/4-5 (Wet/Dry) (EN ISO 105X12)

Pilling: 4-5 (EN ISO 12945-2)

Environmental facts: EU Ecolabel, Oeko-Tex® Standard 100, Contains no Flame Retardant chemicals, ISO 14001 certified company

Design: Cenk Kivrikoglu

Produced in: Lithuania

Cleaning: Wash or dry cleaning. Can be disinfected with ethanol and is bleach-cleanable. (For further info follow Gabriel's cleaning guidelines – www.gabriel.dk)

Xtreme (Camira)

Price group 1

Xtreme is a crepe fabric made from 100% post-consumer recycled polyester that features exceptional Euro flammability performance. Extra stretch and structure gives an irregular, shiny finish.

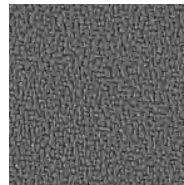

EXR081

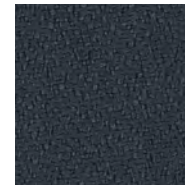

EXR145

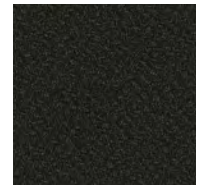

EXR009

Composition: 100% post-consumer recycled polyester

Abrasion resistance: >100 000 Martindale (EN ISO 12947-2)

Flammability: BS EN 1021: 1-2 (Cigarette & match), BS 7176 Low & Medium Hazard, BS 5852 Section 4 Crib 5, DIN 4102 B1, UNI 9175 Class 1 IM, NF D 60-013

Light fastness: 6 (EN ISO 105 - B02: 2013)

Rubbing fastness: 4/4 (Wet/Dry) (EN ISO 105X12)

Pilling: 5 (EN ISO 12945-2)

Environmental facts: EU Ecolabel, Oeko-Tex® Standard 100, Indoor Advantage™ "Gold", non metallic dyestuffs, ISO 14001 certified company.

Design: Camira Design Studio

Produced in: United Kingdom

Cleaning & disinfection: Washable to 60°C and bleach cleanable. (For further info follow Camira's cleaning guidelines – www.camirafabrics.com)

Select (Gabriel)

Price group 2

Select is a classic woolen fabric with a tightly woven relief structure, combining excellent softness, stretch and durability. Its rich texture with the interplay of light and shadow add depth in all the colours in the palette.

Composition: 85% New Zealand wool, 15% polyamide

Abrasion resistance: 200 000 Martindale (EN ISO 12947-2)

Flammability: BS EN 1021: 1–2, BS 5852 0&1, BS5852 Crib 5, CA TB 117-2013, IMO MSC 307(88) Annex 1 part 8/ MED registration IMO

Light fastness: 5-8 (EN ISO 105 - B02)

Rubbing fastness: 4-5/4-5 (Wet/Dry) (EN ISO 105X12)

Pilling: 4 (EN ISO 12945-2)

Environmental facts: EU Ecolabel, Oeko-Tex® Standard 100, 100% free of heavy metals, ISO 14001 certified company

Design: Cenk Kivrikoglu

Produced in: Lithuania

Cleaning: Professional dry cleaning. (For further info follow Gabriel's cleaning guidelines – www.gabriel.dk)

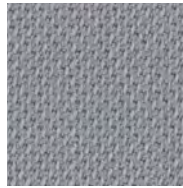

SC60139

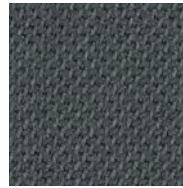

SC60003

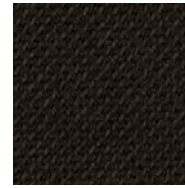

SC60999



SC60134

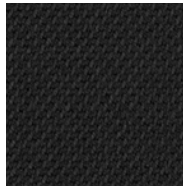

SC60051

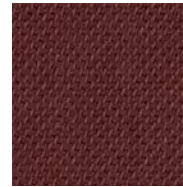

SC61186

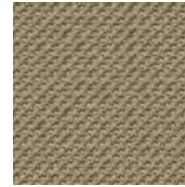

SC61184

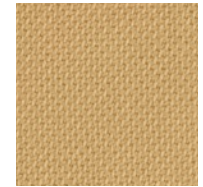

SC62097

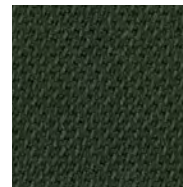

SC68209



SC66194

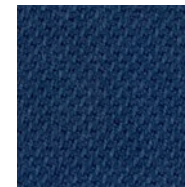

SC66071

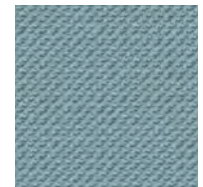

SC67098

Oceanic

Price group 3

Oceanic is made from 100% post-consumer recycled polyester yarn where 90% are created from post-consumer plastic bottles diverted from landfill and 10% is upcycled marine plastic (from marine litter). It is a fabric born out of the SEAQUAL Initiative designed to combat marine plastic pollution and achieve a waste free environment. Oceanic has a two coloured diagonal structure with a matte surface and soft touch.

Composition: 100% post-consumer recycled polyester, including 50% SEAQUAL yarn

Abrasion resistance: >100 000 Martindale (EN ISO 12947-2)

Flammability: BS EN 1021: 1–2 (Cigarette & match), BS 7176 Low, BS 7176 Medium Hazard with EnviroFlam5, CA TB 117-2013

Light fastness: 5 (EN ISO 105 - B02: 2013)

Rubbing fastness: 4/4 (Wet/Dry) (EN ISO 105X12)

Pilling: 4 (EN ISO 12945-2)

Environmental facts: Oeko-Tex® Standard 100, Indoor Advantage™ "Gold", non metallic dyestuffs, ISO 14001 certified company

Produced in: United Kingdom

Cleaning: Washable at 60 °C and bleach cleanable (For further info follow Camira's cleaning guidelines – www.camirafabrics.com)

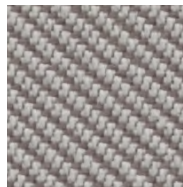

OCI014

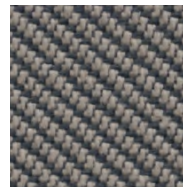

OCI008

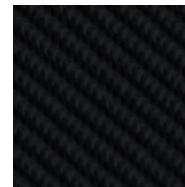

OCI001



OCI011

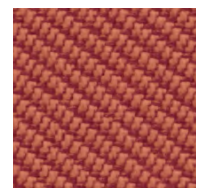

OCI012

Steelcut 3 (Kvadrat)

Price group 4

Steelcut 3 is a unicoloured strong worsted wool and polyamide woven fabric, combining durability, soft touch and colour depth. The construction create a three-dimensional surface resembling small pyramids or steel points. Despite its complex weaving technique, it has a simple and precise expression.

Composition: 90% worsted new wool, 10% polyamide

Abrasion resistance: 100 000 Martindale (EN ISO 12947-2)

Flammability: BS EN 1021: 1-2 (Cigarette & match, CA TB 117-2013, BS 5852 Crib 5 (with treatment), BS 5852 part 1, IMO FTP Code 2010 Part 8, NF D 60 013, NFPA 260, UNI 9175 1IM, ÖNORM B1/Q1, AS/NZS 3837 Class 2, ASTM E84 Class A Unadhered, ASTM 84 Class B Adhered

Light fastness: 5 (EN ISO 105-B02)

Rubbing fastness: 3-5/4-5 (Wet/Dry) (EN ISO 105X12)

Pilling: 3-4 (EN ISO 12945-2)

Environmental facts: EU Ecolabel, 100% free of heavy metals, ISO 14001 certified company, GREENGUARD Gold Design: Frans Dijkmeijer, Giulio Ridolfo (updated colourways)

Produced in: United Kingdom

Cleaning: Professional dry cleaning with tetrachloroethylene, normal process. (For further info follow Kvadrat's cleaning guidelines – www.kvadrat.dk)

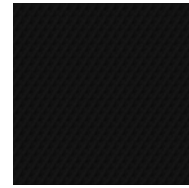

STT190



STT655

Steelcut Trio 3 (Kvadrat)

Price group 4

Steelcut Trio 3 is a strong worsted wool and polyamide woven fabric, made with three different coloured yarns. The colours and the special weave create a three-dimensional surface where the colours seem to change depending on the angle of perspective.

Composition: 90% worsted new wool, 10% polyamide

Abrasion resistance: 100 000 Martindale (EN ISO 12947-2)

Flammability: BS EN 1021: 1-2 (Cigarette & match, AS/NZS 3837, Class 2, BS 5852 Crib 5, BS 5852 part 1, BS 5852 ignition source 3, DIN 4102 B2, ÖNORM B1/Q1,), IMO FTP Code 2010 Part 8, NF D 60 013, NFPA 260, UNI 9175 1IM, CA TB 117-2013

Light fastness: 6-7 (EN ISO 105-B02)

Rubbing fastness: 3-5/4-5 (Wet/Dry) (EN ISO 105X12)

Pilling: 4 (EN ISO 12945-2)

Environmental facts: EU Ecolabel, 100% free of heavy metals, ISO 14001 certified company, GREENGUARD Gold Design: Frans Dijkmeijer, Giulio Ridolfo (updated colourways)

Produced in: United Kingdom

Cleaning: Professional dry cleaning. (For further info follow Kvadrat's cleaning guidelines – www.kvadrat.dk)

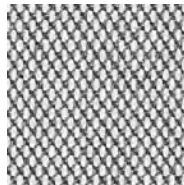

STT133

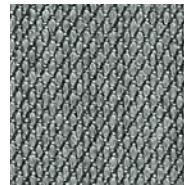

STT153



STT253

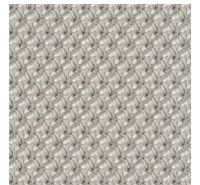

STT213

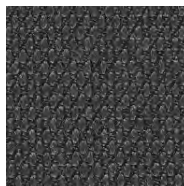

STT383



STT276



STT645



STT796

Frames

Revo Tables

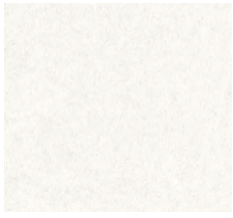

White (RAL 9016)

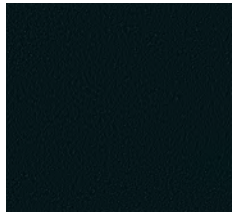

Black (RAL 9005)



Dark green (RAL 6004)



Navy blue (RAL 5003)



Burgundy (RAL 3005)

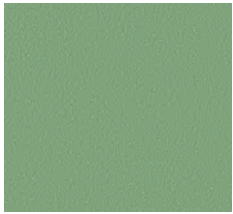

Salvia/Green (RAL 6021)



Blue (RAL 5014)

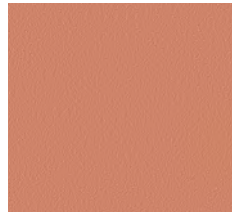

Terracota (RAL 3012)

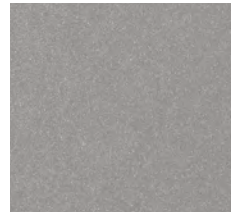

MetallicPro

Natural veneers

Revo Tables



NA (Ash)



NB (Beech)



NO (Oak)



NW (Walnut)

Natural colored veneers (ash)

Revo Tables



CNA01 (White)



CNA02 (Black)

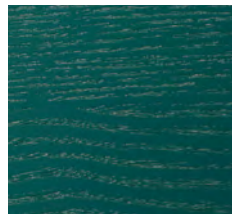

CNA05 (Dark green)

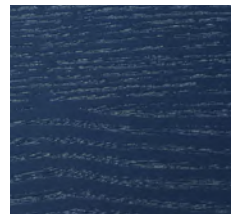

CNA06 (Navy blue)



CNA07 (Burgundy)

HPL

Revo Tables

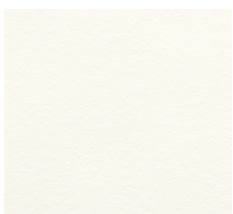

LW01 (White)

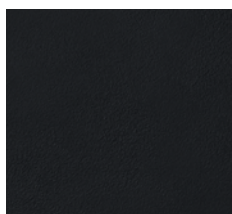

LW02 (Black)

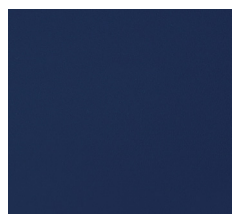

LW06 (Navy blue)

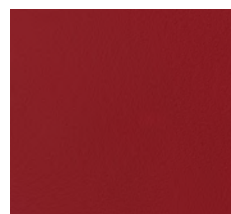

LW07 (Light Burgundy)

Flokk & Kvadrat Curated collection

A carefully selected collection of textiles and colours chosen to provide more specific and inspiring choices for our customers.

A carefully selected collection of textiles and colours chosen to provide more specific and inspiring choices for our customers.

The assortment consists of five different ranges of textiles in a variety of colours and textures – each with distinct features and expressions.

The textile and colour diversity reflects high design and quality and meets the technical and environmental requirements for office interiors and public spaces.

For technical specification, product description and colour overview see website and colour card.

Curated textiles and colours in price group 3:

Atlas: 131, 461, 501, 531, 571, 671, 731, 781, 911, 981

Re-wool: 128, 198, 448, 458, 558, 568, 628, 648, 718, 758, 768, 858

San: 130, 220, 230, 540, 570, 730, 790, 950

Curated textiles and colours in price group 4:

Melange Nap: 111, 171, 191, 211, 241, 371, 411, 521, 651, 751, 911, 951

For more information see our website:

www.info.flokk.com/en/global/flokk-kvadrat



Extended	Price group
Camira Fabrics – www.camirafabrics.com	
Blazer	4
Era	3
Main Line Flax	3
Oceanic*	3
Synergy	3
Urban	3
Xtreme*	3
Gabriel – www.gabriel.dk	
Breeze Fusion	4
Chili	3
Comfort+	5
Cura*	3
Fame	3
Go Check (Trevira CS)	3
Select*	3
Step	3
Step Melange	3
GU – www.gu.no	
Heidal	4
Morgedal	4

Extended	Price group
Kvadrat – www.kvadrat.dk	
Atlas**	3
Canvas 2	5
Coda 2	6
Divina 3	5
Divina Melange 3	5
Melange Nap**	4
Remix 3	4
Re-wool**	3
Steelcut 3*	4
Steelcut Trio 3*	4
Svensson - www.ludvigsvensson.com	
Semi	3

* Non standard colours

** Non curated colours

Legend

profim



net weight



gross weight



joining in rows



teflon glides



felt glides



Mediaport



EPD



Möbelfakta



The Blue Angel

www.blauer-engel.de/uz117

Alphabetical index

Products

Revo	8
Revo Tables	24

Additional information

Consumption of fabric	35
Fabrics - Curated and Extended	44
Fabrics and finishings	40
Glides, table tops and joining in rows	34
Legend	48
Measuring methodology	36
Terms of guarantee	38

Office

Flokk AB

Showroom Försäljning

Box 17198 | 104 62 Stockholm

Rosenlundsgatan 40, trapphus B 3 tr.

118 53 Stockholm

Social Media

Facebook

YouTube

Instagram

Pinterest

LinkedIn

Showroom & Produktion

Vallgatan 1 | Box 294 | 571 23 Nässjö

Tel: 0380-55 53 00

Email: order-se@flokk.com

Web: www.flokk.com